

 MITSUBISHI MATERIALS

FRAISAGE À PLAQUETTES



DIA  **EDGE**

NEW

MITSUBISHI MATERIALS

PRÉSENTATION DU NOUVEAU CATALOGUE GÉNÉRAL C009 – 2022/2023

CIBLÉ, COMPACT, PRATIQUE.

La vaste gamme d'outils Mitsubishi Materials est désormais présentée par domaine d'application, offrant aux utilisateurs un accès rapide et facile à l'information recherchée.

Ce coffret compte 5 volumes :

- **TOURNAGE**
- **PERÇAGE**
- **FRAISAGE MONOBLOC**
- **FRAISAGE À PLAQUETTES**
- **MPLUS**



NOUVEAU DESIGN

NOUVELLES DIMENSIONS

UTILISATION SIMPLIFIÉE

DOMAINE D'APPLICATIONS

Ce coffret facilite le stockage et offre l'espace nécessaire aux prochaines publications comme les brochures « Nouveautés Produits » à paraître au cours du cycle de vie de 2 ans du catalogue général. Pour compléter la collection, vous pourrez ajouter les catalogues supplémentaires dans l'espace prévu à cet effet et effectuer les remplacements au fil des 2 ans.

REMARQUES :

- Cette publication remplace toutes les éditions parues auparavant.
- Les brochures « Nouveautés Produits » sont publiées 2 fois par an en Avril et en Octobre.
- Ce nouveau catalogue général ne peut être commandé que sous la forme du coffret de 5 volumes (**référence C009F**).



VERSION DIGITALE

Pour accéder à la version digitale du catalogue, veuillez scanner le QR code ou visiter notre site www.mhg-mediastore.net

FRAISAGE À PLAQUETTES



EFFICACITÉ ET PRÉCISION

Dépasser les attentes de nos clients : voici la devise de Mitsubishi Materials.

Mitsubishi Materials se concentre sur les attentes de ses clients et développe des solutions économiques et durables pour répondre aux exigences du marché en constante évolution.

De l'ébauche à la finition au micron près, Mitsubishi Materials s'engage à fabriquer et à fournir des fraises à plaquettes de la plus haute qualité.

DIA EDGE

CRÉER UN MEILLEUR AVENIR AVEC NOS CLIENTS

DIAEDGE, notre nouvelle marque rassemble nos outils de technologies de pointe pour tous les utilisateurs passionnés.

Notre objectif n'est pas seulement d'offrir des outils à valeur ajoutée, mais aussi de réfléchir avec nos clients, de partager nos inspirations et de continuer à relever ensemble de nouveaux défis.



MITSUBISHI MATERIALS



INDEX

FRAISAGE À PLAQUETTES

FRAISES À PLAQUETTES	K001
PLAQUETTES DE FRAISAGE	L001
PIÈCES DÉTACHÉES	N001
DONNÉES TECHNIQUES	P001
INDEX	1
INFORMATIONS GÉNÉRALES	



LEXIQUE FRAISES À PLAQUETTES

● Organisation de cette section

- ① Classement par type de fraises.
(Se référer à l'index de la page suivante.)

MATIÈRES Pouvant Être usinées avec cet outil
Diagramme des matières convenant à cet outil.

ANGLE D'ATTAQUE

TYPE / NOM DU PRODUIT

OPÉRATIONS
représente les applications de coupe telles que la finition et l'ébauche.

APPLICATION

OPÉRATIONS
représente les opérations telles que surfacer et surfacer-dresser.

SECTION PRODUIT

GEOMETRIE

CARACTÉRISTIQUES DES PLAQUETTES
indique le type de stock, les dimensions, etc. des plaquettes.

FRAISES À PLAQUETTES
FRAISES À SURFACER
FRAISAGE EN GÉNÉRAL
WSX445

P M K N S H

■ CORPS À DROITE, ATTACHEMENT PAR ALÉSAGE
KAPFR: 45° GAMF: -2° ~ +1°

DC (mm)	Référence	Stock	Nombre de plaquettes	Type	DCX	LF	DCON	WT (kg)	APMX (mm)	Fig.
40	WSX445-040A03AR	●	3	Pas normal	52,8	40	16	0,3	5	1
40	WSX445-040A04AR	●	4	Pas réduit	52,8	40	16	0,3	5	1
50	WSX445-050A03AR	●	3	Pas normal	62,9	40	22	0,5	5	1
50	WSX445-050A04AR	●	4	Pas réduit	62,9	40	22	0,4	5	1
50	WSX445-050A05AR	●	5	Pas extra fin	62,9	40	22	0,4	5	1
63	WSX445-063A04AR	●	4	Pas normal	75,9	40	22	0,6	5	1
63	WSX445-063A05AR	●	5	Pas réduit	75,9	40	22	0,6	5	1
63	WSX445-063A06AR	●	6	Pas extra fin	75,9	40	22	0,6	5	1
80	WSX445-080A04AR	●	4	Pas normal	92,9	50	27	1,3	5	1
80	WSX445-080A06AR	●	6	Pas réduit	92,9	50	27	1,2	5	1
80	WSX445-080A08AR	●	8	Pas extra fin	92,9	50	27	1,1	5	1
100	WSX445-100B05AR	●	5	Pas normal	112,9	50	32	1,9	5	2
100	WSX445-100B07AR	●	7	Pas réduit	112,9	50	32	1,9	5	2
100	WSX445-100B10AR	●	10	Pas extra fin	112,9	50	32	1,8	5	2
125	WSX445-125B06AR	●	6	Pas normal	137,9	63	40	3,4	5	2
125	WSX445-125B08AR	●	8	Pas réduit	137,9	63	40	3,4	5	2
125	WSX445-125B12AR	●	12	Pas extra fin	137,9	63	40	3,2	5	2
160	WSX445-160C07NR	●	7	Pas normal	172,9	83	40	4,9	5	3
160	WSX445-160C10NR	●	10	Pas réduit	172,9	83	40	4,8	5	3
160	WSX445-160C16NR	●	16	Pas extra fin	172,9	83	40	4,6	5	3
200	WSX445-200C08NR	●	8	Pas normal	212,9	83	60	7,5	5	4
200	WSX445-200C12NR	●	12	Pas réduit	212,9	83	60	7,4	5	4
200	WSX445-200C20NR	●	20	Pas extra fin	212,9	83	60	7,2	5	4

Remarque 1) Le corps est fourni sans vis d'attachement.
Remarque 2) Veuillez utiliser une vis d'attachement de type FMC (métrique) pour les corps de fraise d'un diamètre DC de 40 à 100.
Remarque 3) Veuillez utiliser une vis d'attachement de type FMB pour les corps de fraise d'un diamètre DC de 125 à 200.
* WT : poids du corps

PIÈCES DÉTACHÉES

Attachement par alésage	Vis de serrage	Cle (Plaquette)
WSX445	TPS4R	TIP15W

* Couple de serrage (N·m) : TPS4R=3,6

● : Article stocké. * : Article standard Japon.

PLAQUETTES AVEC BRISE-COPEAUX

Matériau	Forme	Référence	DCX	LF	DCON	WT (kg)	APMX (mm)	Fig.
P	G	SNGU140812ANFR-L	14	8,4	1,5	1,2		
M	R	SNGU140812ANER-L	14	8,4	1,5	1,2		
K	ET	SNGU140812ANER-M	14	8,4	1,5	1,2		
N	ET	SNMU140812ANER-M	14	8,4	1,5	1,2		
S	M	SNGU140812ANFL-L	14	8,4	1,5	1,2		
H	M	SNGU140812ANEL-M	14	8,4	1,5	1,2		
	M	SNMU140812ANEL-M	14	8,4	1,5	1,2		
	M	SNMU140812ANEL-R	14	8,4	1,5	1,2		

PLAQUETTES DE PLANAGE

Matériau	Forme	Référence	L	W1	S	BS	RE	Fig.
P	CL	WNGU1406ANENC-M	16,87	16,87	6	8	1,0	

■ INSTRUCTIONS POUR L'UTILISATION DE PLAQUETTES DE PLANAGE

Les plaquettes de planage de la fraise WSX445 possèdent deux arêtes. Positionnez-les comme indiqué sur la Fig.1. Un seul wiper permet d'obtenir un excellent état de surface. Placez plus de 2 plaquettes de planage à équidistance si l'avance dépasse 6 mm/tour.

PIÈCES DÉTACHÉES > N001
DONNÉES TECHNIQUES > P001

LÉGENDE INDICATEURS ÉTAT DE STOCK
en bas à gauche de chaque double page.

PIÈCES DÉTACHÉES POUR FRAISES À PLAQUETTES
indique les références des pièces détachées

CARACTÉRISTIQUES PRODUIT
indique les types de fraises, le numéro de commande, l'état de stock (outil à droite/gauche), les dimensions, etc.

PHOTO DU PRODUIT

● Lors de la commande, veuillez spécifier :

Pour un corps de fraise
Pour une plaquette,

① la référence et le sens (droite/gauche) de l'outil.

② la référence et ③ la nuance.

FRAISAGE À PLAQUETTES

FRAISES À PLAQUETTES

DESCRIPTION DES SYMBOLES K002
 CLASSIFICATION..... K004

FRAISES STANDARD

FRAISES A SURFACER

WSX445..... K016
 ASX445..... K026
 AHX440S..... K034
 AHX475S..... K038
 AHX640S..... K041
 AHX640W..... K048

FRAISES A SURFACER (FORTE AVANCE)

NEW FMAX..... K051

FRAISES A SURFACER-DRESSER

NEW WWX400..... K056
 VOX400..... K065
 ASX400..... K068

FRAISES MULTI FONCTIONS

NEW WJX..... K072
 VPX200..... K086
 VPX300..... K100
 APX3000..... K133
 APX4000..... K140
 AXD4000..... K155
NEW AXD4000A..... K162
 AXD7000..... K166
 AQX..... K172
 AJX..... K180
 ARP..... K238
 BRP..... K190

FRAISES A SURFACER-DRESSER

NEW VPX200 SÉRIE LONGUE..... K114
NEW VPX300 SÉRIE LONGUE..... K124
 APX3000 SÉRIE LONGUE..... K147
 APX4000 SÉRIE LONGUE..... K151
 VFX5..... K192
 VFX6..... K196
 DCCC..... K200
 SPX..... K203
NEW ASPX..... K208

FRAISES HÉMISPHÉRIQUES

SRF,SRB..... K212
 SRM2..... K220
 SRM2 ϕ 40, ϕ 50..... K228

FRAISES TORIQUES à PLAQUETTE

SUF..... K216

CHANFREINAGE

CESP,CFSP,CGSP..... K230

RAINURAGE EN T

TSMP..... K232

TRÉFLAGE

PMF..... K234
 PMR..... K236

RALLONGES

RALLONGES POUR FRAISES VISSÉES... K244

VITESSE DE ROTATION MAXI

AUTORISÉE POUR LES FRAISES... K246

LISTE DES TOLÉRANCES

POUR LE DIAMÈTRE DES FRAISES... K247

*Index alphabétique

K034 AHX440S
 K038 AHX475S
 K041 AHX640S
 K048 AHX640W
 K180 AJX
 K133 APX3000
 K147 APX3000 SÉRIE LONGUE
 K140 APX4000
 K151 APX4000 SÉRIE LONGUE
 K172 AQX
 K238 ARP
 K208 ASPX
 K068 ASX400
 K026 ASX445

K155 AXD4000
 K162 AXD4000A
 K166 AXD7000
 K190 BRP
 K230 CESP/CFSP/CGSP
 K200 DCCC
 K051 FMAX
 K234 PMF
 K236 PMR
 K203 SPX
 K212 SRF/SRB
 K216 SUF
 K220 SRM2
 K228 SRM2 ϕ 40, ϕ 50

K232 TSMP
 K192 VFX5
 K196 VFX6
 K065 VOX400
 K086 VPX200
 K114 VPX200 SÉRIE LONGUE
 K100 VPX300
 K124 VPX300 SÉRIE LONGUE
 K072 WJX09
 K079 WJX14
 K016 WSX445
 K056 WWX400
 K244 RALLONGES POUR
 FRAISES VISSÉES



DESCRIPTION DES SYMBOLES

Liste des KAPR (Angle d'attaque)

15°
KAPR

30°
KAPR

45°
KAPR

50°
KAPR

60°
KAPR

90°
KAPR

R
KAPR

Application

 **Surfçage**

 **Chanfreinage**

 **Surfçage-dressage rayonné**

 **Surfçage en poche**

 **Surfacier-dresser**

 **Fraisage épaulement**

 **Rainurage**

 **Contournage-copiage**

 **Ramping**

 **Rainurage rayonné**

 **Copiage**

 **Rainurage en T**

 **Perçage hélicoïdal**

● : Article stocké.

★ : Article standard Japon.

□ : Article non stocké - Fabrication sur commande uniquement.

K

FRAISES À PLAQUETTES

OPÉRATIONS



Finition



Ébauche moyenne



Ébauche

Groupe Matière

1ère préconisation











2nde préconisation





















CLASSIFICATION (attachement par ALÉSAGE)

K

FRAISES À PLAQUETTES













Nom du produit · Forme	APMX (mm)	Caractéristiques	Dia. Fraise (mm)	Matière	Page
Surfaçage WSX445 	5	<ul style="list-style-type: none"> ● Plaquette réversible de conception unique. ● Prévention de l'écaillage et du collage. ● Grand débit de copeaux. 	Ø40 — Ø200	P M K N S H	K016
Surfaçage ASX445 	6	<ul style="list-style-type: none"> ● Plaquettes économiques de précision, positive à 20°. ● Fixation par vis. ● Une vaste gamme de brise-copeaux. ● Grande rigidité grâce au support carbure. 	Ø50 — Ø315	P M K N S H	K026
Surfaçage AHX440S 	3	<ul style="list-style-type: none"> ● Plaquette réversible heptagonale à double face. ● Economiques avec ses 14 arêtes de coupe. ● Conception à multident pour usinage à grande avance. 	Ø40 — Ø160	P M K H	K034
Surfaçage à grande avance AHX475S 	1.6	<ul style="list-style-type: none"> ● Plaquette réversible heptagonale à double face. ● Economiques avec ses 14 arêtes de coupe. ● Conception à multident pour usinage à grande avance. ● Avec trous d'arrosage. 	Ø50 — Ø160	P K H	K038
Surfaçage AHX640S 	6	<ul style="list-style-type: none"> ● Plaquette réversible heptagonale à double face. ● Economiques avec ses 14 arêtes de coupe. ● Conception à multident pour usinage à grande avance. 	Ø63 — Ø200	P M S H K	K041
Surfaçage fonte à fort rendement AHX640W 	6	<ul style="list-style-type: none"> ● Plaquette réversible heptagonale à double face. ● Economiques avec ses 14 arêtes de coupe. ● Conception à multident pour usinage à grande avance. 	Ø80 — Ø315	K	K048
Finition à forte avance FMAX 	2	<ul style="list-style-type: none"> ● Fraise de finition à très grande vitesse d'avance (FMAX) pour une finition ultra-efficace et précise. ● Corps léger et très rigide, économique et polyvalent ● Avec trous d'arrosage. 	Ø40 — Ø125	K N	K051
Fraises grande avance multi-fonctions NEW WJX09 	1.2	<ul style="list-style-type: none"> ● Plaquettes négatives. ● Serrage robuste avec logement en queue d'aronde. ● Recommandée pour la coupe à grande avance. ● Plaquettes à 6 arêtes de coupe. ● Avec trous d'arrosage. 	Ø40 — Ø66	P M K S H	K072
Fraises grande avance multi-fonctions WJX14 	2.0	<ul style="list-style-type: none"> ● Plaquettes négatives. ● Serrage robuste avec logement en queue d'aronde. ● Recommandée pour la coupe à grande avance. ● Plaquettes à 6 arêtes de coupe. ● Avec trous d'arrosage. 	Ø50 — Ø160	P M K S H	K079

Nom du produit · Forme	APMX (mm)	Caractéristiques	Dia. Fraise (mm)	Matière	Page
Fraises grande avance multi-fonctions AJX 	1.2	<ul style="list-style-type: none"> ● 15° plaquette positive. ● Grande rigidité de la double fixation. ● Recommandée pour la coupe à grande avance. ● Plaquettes à 3 arêtes de coupe. ● Avec trous d'arrosage. 	Ø50 — Ø160		K180
Fraise à plaquettes rondes pour les inox, titanes et réfractaires ARP 	5 6	<ul style="list-style-type: none"> ● Surface d'appui de haute précision pour un saut de plaquette réduit lors de l'indexation. ● Système de serrage plaquette robuste. ● Pas extra fin en outil standard. ● Avec trous d'arrosage. 	Ø40 — Ø100		K238
Fraises à plaquettes rondes BRP 	6 8	<ul style="list-style-type: none"> ● 11° plaquette positive. ● Plaquette ronde renforcée. ● Large choix d'outils disponibles. ● Recommandée pour l'usinage de moules. 	Ø40 — Ø100		K190
Fraise à surfacer-dresser NEW WWX400 	8.2	<ul style="list-style-type: none"> ● Grande raideur de serrage, usinage de grande précision ● Grande résistance à l'écaillage ● Économique, réversible, 6 arêtes. 	Ø50 — Ø250		K056
Fraise à surfacer-dresser pour la fonte VOX400 	10	<ul style="list-style-type: none"> ● Plaquettes tangentielles avec arête de coupe renforcée ● Économiques avec ses 8 arêtes de coupe. ● Fixation par vis. 	Ø50 — Ø250		K065
Fraise à surfacer-dresser ASX400 	10	<ul style="list-style-type: none"> ● Haute précision, et dressage de grande qualité. ● Faible effort de coupe. ● Avec trous d'air et de liquide de coupe. 	Ø50 — Ø250		K068
Fraise à plaquettes tangentielles VPX200 	8	<ul style="list-style-type: none"> ● Plaquette spécialement conçue avec 4 arêtes de coupe. ● Plaquette tangentielle de haute précision et de grande robustesse ● Avec trous d'arrosage. 	Ø32 — Ø63		K089
Fraise à plaquettes tangentielles VPX300 	11	<ul style="list-style-type: none"> ● Plaquette spécialement conçue avec 4 arêtes de coupe. ● Plaquette tangentielle de haute précision et de grande robustesse ● Avec trous d'arrosage. 	Ø40 — Ø80		K103
Fraise multi-fonctions APX3000 	10	<ul style="list-style-type: none"> ● Faible effort de coupe. ● Haute précision, et dressage de grande qualité. ● Avec trous d'air et de liquide de coupe. 	Ø32 — Ø100		K135



























CLASSIFICATION (attachement par ALÉSAGE)

K

FRAISES À PLAQUETTES

Nom du produit · Forme	APMX (mm)	Caractéristiques	Dia. Fraise (mm)	Matière	Page
Fraise multi-fonctions APX4000  	15	<ul style="list-style-type: none"> ● Faible effort de coupe. ● Haute précision, et dressage de grande qualité. ● Avec trous d'air et de liquide de coupe. 	Ø40 — Ø160		K142
Fraise multi-fonctions pour l'aluminium AXD4000  	14.8 15.5	<ul style="list-style-type: none"> ● Faible puissance absorbée grâce au brise-copeaux. ● Faible effort de coupe et grande rigidité pour d'excellentes performances. ● Pour l'usinage haute vitesse. ● L'usinage multi-fonction. ● Avec trous d'arrosage. 	Ø40 — Ø125		K155
Fraise très hautes performances pour l'aluminium NEW AXD4000A  	14.8 15.5	<ul style="list-style-type: none"> ● Faible puissance absorbée grâce au brise-copeaux. ● Faible effort de coupe et grande rigidité pour d'excellentes performances. ● Pour un usinage à fort débit sur machines de très grande puissance ● L'usinage multi-fonction. 	Ø50		K162
Fraise multi-fonctions pour l'aluminium AXD7000  	20.4 21	<ul style="list-style-type: none"> ● Faible puissance absorbée grâce au brise-copeaux. ● Faible effort de coupe et grande rigidité pour d'excellentes performances. ● Pour l'usinage haute vitesse. ● L'usinage multi-fonction. ● Avec trous d'arrosage. 	Ø50 — Ø125		K166



















CLASSIFICATION (attachement CYLINDRIQUE)



























Nom du produit · Forme	APMX (mm)	Caractéristiques	Dia. Fraise (mm)	Matière	Page
WSX445  	5	<ul style="list-style-type: none"> ● Plaquette réversible de conception unique. ● Prévention de l'écaillage et du collage. ● Grand débit de copeaux. ● Avec trous d'arrosage. 	Ø40 — Ø63		K018
ASX445  	6	<ul style="list-style-type: none"> ● Plaquettes frittées, précises économiques, positives à 20°. ● Fixation à vis. ● Large choix de brise-copeaux. ● Grande rigidité grâce au support carbure. 	Ø50 Ø63		K027
WWX400  	8.2	<ul style="list-style-type: none"> ● Grande raideur de serrage, usinage de grande précision ● Grande résistance à l'écaillage ● Économique, réversible, 6 arêtes. 	Ø50 — Ø80		K058
ASX400  	10	<ul style="list-style-type: none"> ● Plaquettes de précision brutes de frittage ● Économiques avec ses 4 arêtes de coupe. ● Arête de coupe incurvée, grande rigidité du corps. ● Fixation par vis. 	Ø40 — Ø63		K069
VPX200  	8	<ul style="list-style-type: none"> ● Plaquette spécialement conçue avec 4 arêtes de coupe. ● Plaquette tangentielle de haute précision et de grande robustesse ● Avec trous d'arrosage. 	Ø16 — Ø50		K086
VPX300  	11	<ul style="list-style-type: none"> ● Plaquette spécialement conçue avec 4 arêtes de coupe. ● Plaquette tangentielle de haute précision et de grande robustesse ● Avec trous d'arrosage. 	Ø25 — Ø50		K100
APX3000  	10	<ul style="list-style-type: none"> ● Haute précision, et dressage de grande qualité. ● Faible effort de coupe. ● Avec trous d'air et de liquide de coupe. 	Ø12 — Ø63		K133
APX4000  	15	<ul style="list-style-type: none"> ● Haute précision, et dressage de grande qualité. ● Faible effort de coupe. ● Avec trous d'air et de liquide de coupe. 	Ø25 — Ø63		K140
AXD4000  	14.8 15.5	<ul style="list-style-type: none"> ● Faible puissance absorbée grâce au brise-copeaux. ● Faible effort de coupe et grande rigidité pour d'excellentes performances. ● Pour l'usinage haute vitesse. ● L'usinage multi-fonction. ● Avec trous d'arrosage. 	Ø20 — Ø40		K156

K

FRAISES À PLAQUETTES

CLASSIFICATION (attachement CYLINDRIQUE)









Nom du produit · Forme	APMX (mm)	Caractéristiques	Dia. Fraise (mm)	Matière	Page
AXD7000  	20.4 21	<ul style="list-style-type: none"> ● Faible puissance absorbée grâce au brise-copeaux. ● Faible effort de coupe et grande rigidité pour d'excellentes performances. ● Pour l'usinage haute vitesse. ● L'usinage multi-fonction. ● Avec trous d'arrosage. 	Ø32 — Ø50	N	K166
AQX  	7.4 55	<ul style="list-style-type: none"> ● La coupe au centre permet de percer sans centrage au préalable. ● Avec trous d'arrosage. 	Ø16 — Ø50	P M K N S H	K172
AJX 	0.6 1.2	<ul style="list-style-type: none"> ● 13° et 15° plaquette positive. ● Grande rigidité de la double fixation. ● Recommandée pour la coupe à grande avance. ● Plaquettes à 3 arêtes de coupe. ● Avec trous d'arrosage. 	Ø16 — Ø63	P M K S H	K183
WJX09  	1.2	<ul style="list-style-type: none"> ● Fraises multi fonctions. ● Plaquettes négatives. ● Grande raideur de serrage, usinage de grande précision ● Recommandée pour la coupe à grande avance. ● Plaquettes à 6 arêtes de coupe. ● Avec trous d'arrosage. 	Ø25 — Ø40	P M K S H	K073
WJX14 	2.0	<ul style="list-style-type: none"> ● Fraises multi fonctions. ● Plaquettes négatives. ● Grande raideur de serrage, usinage de grande précision ● Recommandée pour la coupe à grande avance. ● Plaquettes à 6 arêtes de coupe. ● Avec trous d'arrosage. 	Ø50	P M K S H	K080
ARP  	5 6	<ul style="list-style-type: none"> ● Surface d'appui de haute précision pour un saut de plaquette réduit lors de l'indexation. ● Système de serrage plaquette robuste. ● Pas extra fin en outil standard. ● Avec trous d'arrosage. 	Ø25 — Ø50	M S	K239
VPX200 Série longue   	14 42	<ul style="list-style-type: none"> ● Plaquette spécialement conçue avec 4 arêtes de coupe. ● Plaquette de haute précision avec plat de planage. ● Avec trous d'arrosage. 	Ø20 — Ø40	P M K N S	K115
VPX200 Fraise à Alésage   	35 42	<ul style="list-style-type: none"> ● Plaquette spécialement conçue avec 4 arêtes de coupe. ● Plaquette de haute précision avec plat de planage. ● Avec trous d'arrosage. 	Ø32 — Ø50	P M K N S	K116
VPX300 Série longue   	21 42	<ul style="list-style-type: none"> ● Plaquette spécialement conçue avec 4 arêtes de coupe. ● Plaquette de haute précision avec plat de planage. ● Avec trous d'arrosage. 	Ø40	P M K N S	K124





Nom du produit · Forme	APMX (mm)	Caractéristiques	Dia. Fraise (mm)	Matière	Page
VPX300 Fraise à Alésage  	31 63	<ul style="list-style-type: none"> ● Plaquette spécialement conçue avec 4 arêtes de coupe. ● Plaquette de haute précision avec plat de planage. ● Avec trous d'arrosage. 	Ø40 — Ø80		K125
APX3000 Série longue  	28 55	<ul style="list-style-type: none"> ● Haute précision, et dressage de grande qualité. ● Faible effort de coupe. 	Ø20 — Ø40		K147
APX3000 Fraise à Alésage  	37 46	<ul style="list-style-type: none"> ● Haute précision, et dressage de grande qualité. ● Faible effort de coupe. ● Avec trous d'arrosage. 	Ø40 Ø50		K148
APX4000 Série longue  	56 84	<ul style="list-style-type: none"> ● Haute précision, et dressage de grande qualité. ● Faible effort de coupe. ● Avec trous d'air et de liquide de coupe. 	Ø40 Ø50		K151
APX4000 Fraise à Alésage  	42 56	<ul style="list-style-type: none"> ● Haute précision, et dressage de grande qualité. ● Faible effort de coupe. ● Avec trous d'arrosage. 	Ø50 Ø63		K152
DCCC  	27 83	<ul style="list-style-type: none"> ● Hélice variable pour empêcher les vibrations. 	Ø25 — Ø40		K200
SPX  	110 261	<ul style="list-style-type: none"> ● Faible effort de coupe grâce à l'utilisation de plaquettes ondulées. ● Recommandée pour les coupes difficiles grâce à la rigidité de l'outil. 	Ø63		K203
SPX Fraise à Alésage  	58	<ul style="list-style-type: none"> ● Faible effort de coupe grâce à l'utilisation de plaquettes ondulées. ● Recommandée pour les coupes difficiles grâce à la rigidité de l'outil. 	Ø63 Ø80		K204
ASPX Fraise à Alésage  	54 75	<ul style="list-style-type: none"> ● Haute performance pour le fraisage des alliages de titane. ● Faible effort de coupe grâce à l'utilisation de plaquettes ondulées. ● Recommandée pour les coupes difficiles grâce à la rigidité de l'outil. 	Ø50 — Ø80		K208

K

FRAISES À PLAQUETTES

CLASSIFICATION (attachement CYLINDRIQUE)



























Nom du produit · Forme	APMX (mm)	Caractéristiques	Dia. Fraise (mm)	Matière	Page
ASPX 	127	<ul style="list-style-type: none"> ● Haute performance pour le fraisage des alliages de titane. ● Faible effort de coupe grâce à l'utilisation de plaquettes ondulées. ● Recommandée pour les coupes difficiles grâce à la rigidité de l'outil. 	Ø80	S	K209
VFX5 	26 75	<ul style="list-style-type: none"> ● Haute performance pour le fraisage des alliages de titane. ● Conception à rigidité extrêmement élevée. ● Mécanisme de fixation extrêmement fiable. ● Avec trous d'arrosage. 	Ø40 — Ø80	S	K192
VFX6 	31 90	<ul style="list-style-type: none"> ● Haute performance pour le fraisage des alliages de titane. ● Conception à rigidité extrêmement élevée. ● Mécanisme de fixation extrêmement fiable. ● Avec trous d'arrosage. 	Ø63 — Ø100	S	K196
SRF/SRB 	5 17	<ul style="list-style-type: none"> ● Les arêtes de coupe affûtées de type S procurent une acuité similaire aux fraises deux tailles monoblocs. ● Grande précision du rayon permettant une finition précise. ● Corps carbure disponible. 	Ø10 — Ø32	P K N H	K212
SUF 	1.5 5.2	<ul style="list-style-type: none"> ● Grande précision du rayon permettant une finition précise. ● Profil de coupe sans passage. 	Ø10 — Ø32	P M K H	K216
SRM2 	12 44	<ul style="list-style-type: none"> ● Recommandée pour ébauche et semi-finition des moules et matrices. ● Haute rigidité du corps. ● Faible puissance absorbée grâce au brise-copeaux. ● Fraise avec arrosage central. 	Ø16 — Ø32	P M K S H	K220
SRM2 Ø40/Ø50 	54 63	<ul style="list-style-type: none"> ● Idéale pour l'ébauche des moules et matrices. ● Faible puissance absorbée grâce au brise-copeaux. ● Corps extrêmement rigide. 	Ø40 Ø50	P K	K228
CESP·CFSP·CGSP 	5.9 10.2	<ul style="list-style-type: none"> ● Couvre 5 types d'opérations. ● Excellente acuité des plaquettes à coupe positive 11°. ● 30°, 45° et 60° d'angle d'attaque. 	Ø8 — Ø32	P K	K230
TSMP 	11 18	<ul style="list-style-type: none"> ● Fraise pour rainure en T14, 18 et 22 disponibles. ● Plaquette rhombique à 86°, dépouille à 11°. ● Épaulement et contre-lamage également possible. 	Ø25 — Ø40	P K	K232













Nom du produit · Forme	APMX (mm)	Caractéristiques	Dia. Fraise (mm)	Matière	Page
PMF 	0.1	<ul style="list-style-type: none"> ● Fraise à tréfler. ● Plaquettes réglables. ● Excellente précision. 	Ø50 — Ø80		K234
PMR 	11	<ul style="list-style-type: none"> ● Fraise à tréfler. ● Le fraisage horizontal et oblique sont également possibles. ● Forme unique de plaquette incurvée pour une grande rigidité et un faible effort de coupe. 	Ø50 — Ø63		K236

CLASSIFICATION (fraise à EMBOUT FILETÉ)

K

FRAISES À PLAQUETTES











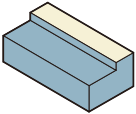

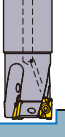

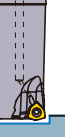





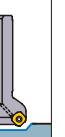

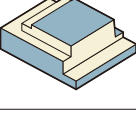











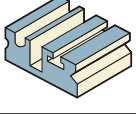









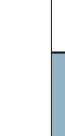

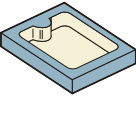











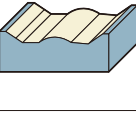











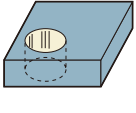

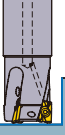









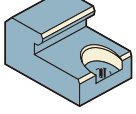









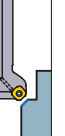

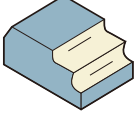

Nom du produit · Forme	APMX (mm)	Caractéristiques	Dia. Fraise (mm)	Matière	Page
ASX400  	10	<ul style="list-style-type: none"> ● Plaquettes de précision brutes de frittage. ● Economiques avec ses 4 arêtes de coupe. ● Arête de coupe incurvée, grande rigidité du corps. ● Fixation par vis. ● Avec trous d'arrosage. 	Ø32 Ø40		K069
APX3000  	10	<ul style="list-style-type: none"> ● Haute précision, et dressage de grande qualité. ● Faible effort de coupe. ● Avec trous d'air et de liquide de coupe. 	Ø16 — Ø40		K136
APX4000  	15	<ul style="list-style-type: none"> ● Haute précision, et dressage de grande qualité. ● Faible effort de coupe. ● Avec trous d'air et de liquide de coupe. 	Ø25 — Ø40		K143
AQX  	7.4 18	<ul style="list-style-type: none"> ● La coupe au centre permet de percer sans centrage au préalable. ● Avec trous d'arrosage. 	Ø16 — Ø40		K174
VPX200  	8	<ul style="list-style-type: none"> ● Plaquette spécialement conçue avec 4 arêtes de coupe. ● Plaquette de haute précision avec plat de planage. ● Avec trous d'arrosage. 	Ø16 — Ø40		K088
VPX300  	11	<ul style="list-style-type: none"> ● Plaquette spécialement conçue avec 4 arêtes de coupe. ● Plaquette de haute précision avec plat de planage. ● Avec trous d'arrosage. 	Ø25 — Ø40		K102
AJX 	0.6 1.2	<ul style="list-style-type: none"> ● Plaquette positive à 13° ou 15°. ● Grande rigidité de la double fixation. ● Recommandée pour la coupe à grande avance. ● Plaquettes à 3 arêtes de coupe. ● Avec trous d'arrosage. 	Ø16 — Ø40		K182
WJX09  	1.2	<ul style="list-style-type: none"> ● Fraises multi fonctions. ● Plaquettes négatives. ● Serrage robuste avec logement en queue d'aronde. ● Recommandée pour la coupe à grande avance. ● Plaquettes à 6 arêtes de coupe. ● Avec trous d'arrosage. 	Ø25 — Ø40		K073
ARP  	5 6	<ul style="list-style-type: none"> ● Fraise à plaquettes rondes ● Surface d'appui de haute précision pour un saut de plaquette réduit lors de l'indexation. ● Système de serrage plaquette robuste. ● Avec trous d'arrosage. 	Ø25 — Ø40		K240











Nom du produit · Forme	APMX (mm)	Caractéristiques	Dia. Fraise (mm)	Matière	Page
BRP  	4 6	<ul style="list-style-type: none"> ● Fraise à plaquettes rondes ● Plaquette positive à 11° ● Plaquette ronde renforcée. ● Large choix d'outils disponibles. ● Recommandée pour l'usinage de moules. 	Ø16 — Ø42		K190
SRF/SRB  	8 17	<ul style="list-style-type: none"> ● Les arêtes de coupe affûtées de type S procurent une acuité similaire aux fraises deux tailles monoblocs. ● Grande précision du rayon permettant une finition précise. ● Corps carbure disponible. ● Avec trous d'arrosage. 	Ø16 — Ø32		K213
SUF  	2.1 5.2	<ul style="list-style-type: none"> ● Grande précision du rayon permettant une finition précise. ● Profil de coupe sans passage. ● Avec trous d'arrosage. 	Ø16 — Ø32		K217
SRM2  	12 44	<ul style="list-style-type: none"> ● Recommandée pour ébauche et semi-finition des moules et matrices. ● Haute rigidité du corps. ● Faible puissance absorbée grâce au brise-copeaux. ● Avec trous d'arrosage. 	Ø16 — Ø32		K222

CLASSIFICATION

FRAISES À PLAQUETTES

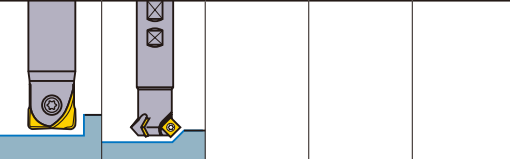
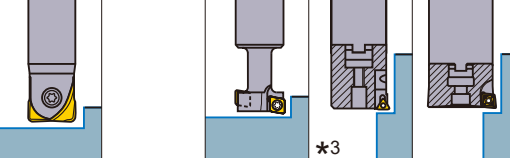
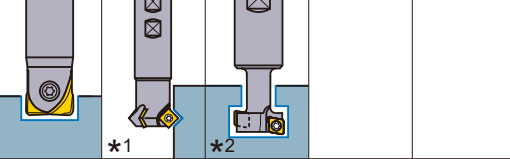
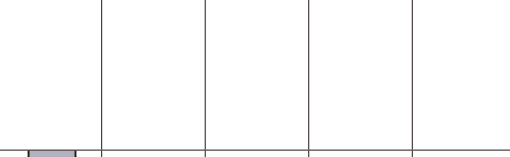
K

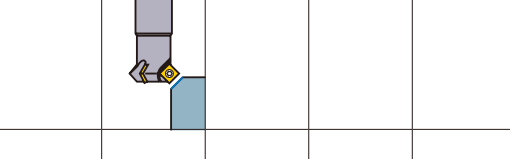
	Multifonctions							Générale			Hérisson
Désignation	VPX200 VPX300	APX3000 APX4000	AXD4000 AXD7000	NEW WJX09 WJX14	AJX	AQX	ARP	NEW WWX400	ASX400	ASX445 WSX445	NEW VPX200 VPX300 Série Longue
Opération	↻ K086 ↻ K100	↻ K133 ↻ K140	↻ K156 ↻ K166	↻ K073 ↻ K080	↻ K183	↻ K172	↻ K239	↻ K058	↻ K069	↻ K027 ↻ K018	↻ K114 ↻ K124
Surfaçage 											
Surfacé-dresser 											
Rainurage 											
Fraisage de poches 											
Copiage 											
Perçage hélicoïdal 											
Chanfreinage 											
Rayonnage 											

Hérisson					Hémisphérique/torique				Usinage Spécifique			
APX3000 APX4000 Série Longue  ↻ K147 ↻ K151	DCCC  ↻ K200	VFX5 VFX6  ↻ K192 ↻ K196	NEW ASPX  ↻ K208	SPX  ↻ K203	SRM2  ↻ K220	SRM2 $\phi 40/\phi 50$  ↻ K228	SRF/SRB Pour la finition  ↻ K212	SUF Pour la finition  ↻ K216	CESP CFSP CGSP  ↻ K230	TSMP  ↻ K232	PMF  ↻ K234	PMR  ↻ K236
												
												
												
												
												
												
												
												

*1 Rainurage en V *2 Rainurage en T *3 Plongée

FRAISES À PLAQUETTES

FRAISES À SURFACER <FRAISAGE EN GÉNÉRAL>



WSX445



K

FRAISES À PLAQUETTES

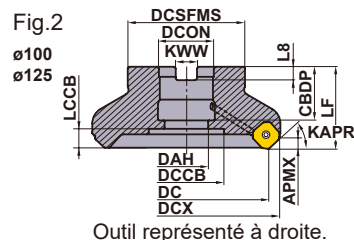
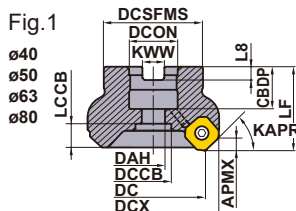

■ CORPS À DROITE, ATTACHEMENT PAR ALÉSAGE

KAPR : 45°

GAMP : +17°

GAMF : -6° - +1°

DC (mm)	Référence	Stock	Trou d'arrosage	Nombre de dents	Type	Dimensions (mm)			WT* (kg)	APMX (mm)	Fig.
						DCX	LF	DCON			
40	WSX445-040A03AR	●	○	3	Pas normal	52.8	40	16	0.3	5	1
40	WSX445-040A04AR	●	○	4	Pas réduit	52.8	40	16	0.3	5	1
50	WSX445-050A03AR	●	○	3	Pas normal	62.9	40	22	0.5	5	1
50	WSX445-050A04AR	●	○	4	Pas réduit	62.9	40	22	0.4	5	1
50	WSX445-050A05AR	●	○	5	Pas extra fin	62.9	40	22	0.4	5	1
63	WSX445-063A04AR	●	○	4	Pas normal	75.9	40	22	0.6	5	1
63	WSX445-063A05AR	●	○	5	Pas réduit	75.9	40	22	0.6	5	1
63	WSX445-063A06AR	●	○	6	Pas extra fin	75.9	40	22	0.6	5	1
80	WSX445-080A04AR	●	○	4	Pas normal	92.9	50	27	1.3	5	1
80	WSX445-080A06AR	●	○	6	Pas réduit	92.9	50	27	1.2	5	1
80	WSX445-080A08AR	●	○	8	Pas extra fin	92.9	50	27	1.1	5	1
100	WSX445-100B05AR	●	○	5	Pas normal	112.9	50	32	1.9	5	2
100	WSX445-100B07AR	●	○	7	Pas réduit	112.9	50	32	1.9	5	2
100	WSX445-100B10AR	●	○	10	Pas extra fin	112.9	50	32	1.8	5	2
125	WSX445-125B06AR	●	○	6	Pas normal	137.9	63	40	3.4	5	2
125	WSX445-125B08AR	●	○	8	Pas réduit	137.9	63	40	3.4	5	2
125	WSX445-125B12AR	●	○	12	Pas extra fin	137.9	63	40	3.2	5	2
160	WSX445-160C07NR	●	-	7	Pas normal	172.9	63	40	4.9	5	3
160	WSX445-160C10NR	●	-	10	Pas réduit	172.9	63	40	4.8	5	3
160	WSX445-160C16NR	●	-	16	Pas extra fin	172.8	63	40	4.6	5	3
200	WSX445-200C08NR	●	-	8	Pas normal	212.9	63	60	7.5	5	4
200	WSX445-200C12NR	●	-	12	Pas réduit	212.9	63	60	7.4	5	4
200	WSX445-200C20NR	●	-	20	Pas extra fin	212.8	63	60	7.2	5	4

Remarque 1) Le corps est fourni sans vis d'attachement.

Remarque 2) Veuillez utiliser une vis d'attachement de type FMC (métrique) pour les corps de fraise d'un diamètre DC de 40 à 100.

Remarque 3) Veuillez utiliser une vis d'attachement de type FMB pour les corps de fraise d'un diamètre DC de 125 à 200.

* WT : poids du corps

PIÈCES DÉTACHÉES

	*	
Attachement par alésage		
	Vis de serrage	Clé (Plaquette)
WSX445	TPS4R	TIP15W

* Couple de serrage (N • m) : TPS4R=3,5

● : Article stocké. ★ : Article standard Japon.

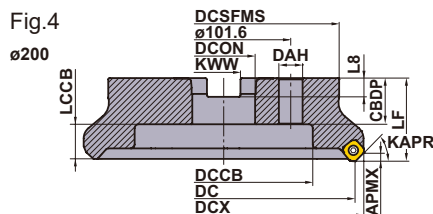
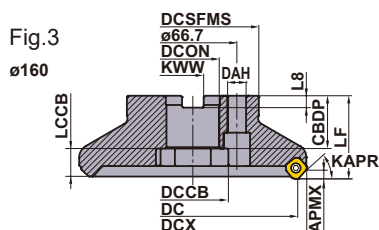

Outil représenté à droite.

■ CORPS À GAUCHE, ATTACHEMENT PAR ALÉSAGE

DC (mm)	Référence	Stock	Trou d'arrosage	Nombre de dents	Type	Dimensions (mm)			WT [*] (kg)	APMX (mm)	Fig.
						DCX	LF	DCON			
80	WSX445-080A04AL	★	○	4	Pas normal	92.9	50	27	1.3	5	1
100	WSX445-100B05AL	★	○	5	Pas normal	112.9	50	32	1.9	5	2
125	WSX445-125B06AL	★	○	6	Pas normal	137.9	63	40	3.4	5	2
160	WSX445-160C07NL	★	—	7	Pas normal	172.9	63	40	4.9	5	3

Remarque 1) Le corps est fourni sans vis d'attachement.

Remarque 2) Veuillez utiliser une vis d'attachement de type FMC (métrique) pour les corps de fraise d'un diamètre DC de 40 à 100.

Remarque 3) Veuillez utiliser une vis d'attachement de type FMB pour les corps de fraise d'un diamètre DC de 125 à 200.

* WT : poids du corps

VIS D'ATTACHEMENT (VENDUE SÉPARÉMENT)

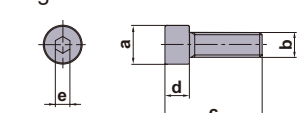
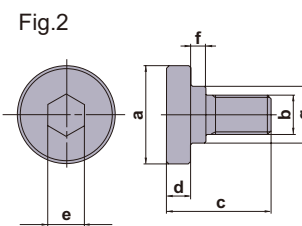
Attachement par alésage	Vis d'attachement		Type	Dimensions (mm)							Géométrie
	Avec trou d'arrosage	Sans trou d'arrosage		a	b	c	d	e	f	g	
	Référence	Référence									
WSX445-040A○○AR	HSC08025H	HSC08040	1	13	M8×1.25	33	8	5	—	—	Fig.1 
WSX445-050A○○AR	HSC10030H	HSC10035	1	16	M10×1.5	40	10	6	—	—	
WSX445-063A○○AR	HSC10030H	HSC10035	1	16	M10×1.5	40	10	6	—	—	Fig.2 
WSX445-080A○○A○	HSC12035H	HSC12035 (HSC12045)	1	18	M12×1.75	47 57	12	10	—	—	
WSX445-100B○○A○	MBA16033H	—	2	40	M16×2	43	10	14	6	23	
WSX445-125B○○A○	MBA20040H	—	2	50	M20×2.5	54	14	17	6	27	
WSX445-160C○○N○	Sans trous d'arrosage	—	2	50	M20×2.5	54	14	17	6	27	
WSX445-200C○○NR	Sans trous d'arrosage	—	1	24	M16×2	43	16	14	—	—	

Remarque 1) Une vis percée spécifique est nécessaire pour utiliser l'arrosage interne.

FRAISES À PLAQUETTES

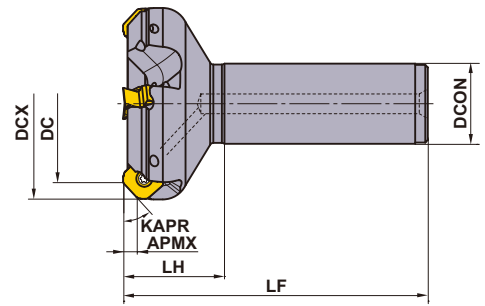
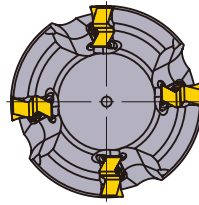

Outil à droite uniquement.

K



FRAISES À PLAQUETTES

■ ATTACHEMENT CYLINDRIQUE

DC (mm)	Référence	Stock	Trou d'arrosage	Nombre de dents	Type	Dimensions (mm)				WT [*] (kg)	APMX (mm)
						DCX	LF	DCON	LH		
40	WSX445R4003SA32M	★	○	3	Pas normal	52.8	125	32	40	0.8	5
40	WSX445R4004SA32M	★	○	4	Pas réduit	52.8	125	32	40	0.8	5
50	WSX445R5003SA32M	★	○	3	Pas normal	62.9	125	32	40	1.0	5
50	WSX445R5004SA32M	★	○	4	Pas réduit	62.9	125	32	40	1.0	5
63	WSX445R6304SA32M	★	○	4	Pas normal	75.9	125	32	40	1.2	5
63	WSX445R6305SA32M	★	○	5	Pas réduit	75.9	125	32	40	1.2	5

* WT : Poids de l'outil

PIÈCES DÉTACHÉES

Attachement par alésage	*	
	 Vis de serrage	 Clé (Plaquette)
WSX445	TPS4R	TIP15W

* Couple de serrage TPS4R : 3,5 Nm

● : Article stocké. ★ : Article standard Japon.
(10 plaquettes par boîte)

K018

PLAQUETTES AVEC BRISE-COPEAUX

Matière	P	Acier											Conditions de coupe : ● : Coupe Stable ● : Coupe Générale ✦ : Coupe Instable Honing : E : Ronde F : Affûtée									
	M	Acier Inoxydable																				
Matière	K	Fonte																				
	N	Non ferreux																				
	S	Alliage réfractaire, Alliage titane																				
	H	Acier trempé																				
Forme	Référence	Classe	Sens	Honing	Revêtu								Cermet	Carbure	Dimensions (mm)				Géométrie			
					MC5020	MP6120	MP6130	MP7130	MP7140	MP9120	VP15TF	VP20RT	MX3030	TF15	IC	S	BS	RE				
	SNGU140812ANFR-L	G	R	F												●		14	8.4	1.5	1.2	 Plaquette représentée à droite.
	SNGU140812ANER-L	G	R	E	●	●	●	●	●	●	★	★	●					14	8.4	1.5	1.2	
	SNGU140812ANER-M	G	R	E	●	●	●	●	●	●	★	★	●					14	8.4	1.5	1.2	
	SNMU140812ANER-M	M	R	E	●	●	●	●	●	●	★	★	●					14	8.4	1.5	1.2	
	SNMU140812ANER-R	M	R	E	●	●					★	★						14	8.4	1.5	1.2	
	SNMU140812ANER-H	M	R	E	●	●					★	★						14	8.4	1.5	1.2	
	SNGU140812ANFL-L	G	L	F											★			14	8.4	1.5	1.2	
	SNGU140812ANEL-L	G	L	E	★	★	★				★	★						14	8.4	1.5	1.2	
	SNGU140812ANEL-M	G	L	E	★	★	★				★	★						14	8.4	1.5	1.2	
	SNMU140812ANEL-M	M	L	E	★	★	★				★	★						14	8.4	1.5	1.2	
SNMU140812ANEL-R	M	L	E	★	★					★							14	8.4	1.5	1.2		

K

FRAISES À PLAQUETTES

PLAQUETTES DE PLANAGE

Matière	P	Acier											Conditions de coupe : ● : Coupe Stable ● : Coupe Générale ✦ : Coupe Instable Honing : E : Ronde F : Affûtée	
	M	Acier Inoxydable												
Matière	K	Fonte												
	S	Alliage réfractaire, Alliage titane												
	H	Acier trempé												
	Forme	Référence	Classe	Honing	Revêtu				Cermet	Dimensions (mm)				
MC5020					MP6120	VP15TF	MX3020	L	W1	S	BS	RE		
	WNGU1406ANEN8C-M	G	E	●	●	●	●		16.87	16.87	6	8	1.0	

INSTRUCTIONS POUR L'UTILISATION DE PLAQUETTES DE PLANAGE



Fig.1



Fig.2

Les plaquettes de planage de la fraise WSX445 possèdent deux arêtes. Positionnez-les comme indiqué sur la fig.1.

Un seul wiper permet d'obtenir un excellent état de surface.

Placez plus de 2 plaquettes de planage à équidistance si l'avance dépasse 8 mm/tour.

DIMENSIONS DE MONTAGE DES CORPS

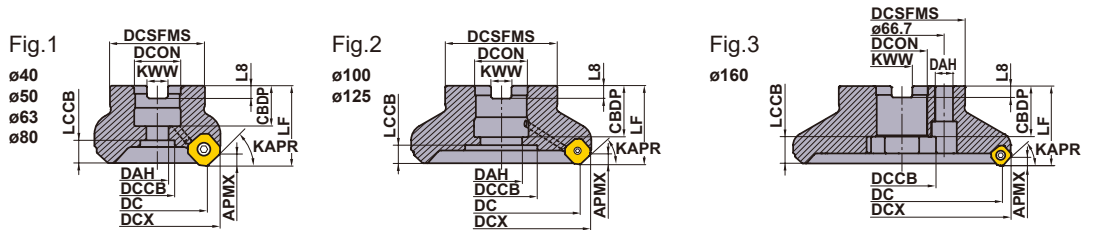

Outil représenté à droite.

DC (mm)	Référence	Dimensions (mm)								Fig.
		DCON	CBDP	DAH	DCCB	LCCB	DCSFMS	KWW	L8	
40	WSX445-040A03AR	16	18	9	14	13.3	37	8.4	5.6	1
40	WSX445-040A04AR	16	18	9	14	13.3	37	8.4	5.6	1
50	WSX445-050A03AR	22	20	11	17	11.3	47	10.4	6.3	1
50	WSX445-050A04AR	22	20	11	17	11.3	47	10.4	6.3	1
50	WSX445-050A05AR	22	20	11	17	11.3	47	10.4	6.3	1
63	WSX445-063A04AR	22	20	11	17	11.3	50	10.4	6.3	1
63	WSX445-063A05AR	22	20	11	17	11.3	50	10.4	6.3	1
63	WSX445-063A06AR	22	20	11	17	11.3	50	10.4	6.3	1
80	WSX445-080A04AR	27	23	13	20	14.3	56	12.4	7	1
80	WSX445-080A06AR	27	23	13	20	14.3	56	12.4	7	1
80	WSX445-080A08AR	27	23	13	20	14.3	56	12.4	7	1
80	WSX445-080A04AL	27	23	13	20	14.3	56	12.4	7	1
100	WSX445-100B05AR	32	26	26	45	16.3	78	14.4	8	2
100	WSX445-100B07AR	32	26	26	45	16.3	78	14.4	8	2
100	WSX445-100B10AR	32	26	26	45	16.3	78	14.4	8	2
100	WSX445-100B05AL	32	26	26	45	16.3	78	14.4	8	2
125	WSX445-125B06AR	40	28	30	56	21.3	89	16.4	9	2
125	WSX445-125B08AR	40	28	30	56	21.3	89	16.4	9	2
125	WSX445-125B12AR	40	28	30	56	21.3	89	16.4	9	2
125	WSX445-125B06AL	40	28	30	56	21.3	89	16.4	9	2

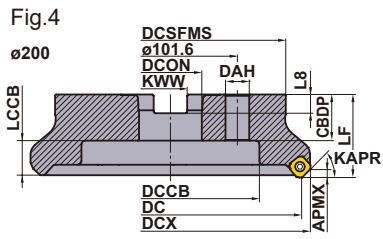

Outil représenté à droite.

DC (mm)	Référence	Dimensions (mm)								Fig.
		DCON	CBDP	DAH	DCCB	LCCB	DCSFMS	KWW	L8	
160	WSX445-160C07NR	40	40	14	56	21.3	100	16.4	9	3
160	WSX445-160C10NR	40	40	14	56	21.3	100	16.4	9	3
160	WSX445-160C16NR	40	40	14	56	21.3	100	16.4	9	3
160	WSX445-160C07NL	40	40	14	56	21.3	100	16.4	9	3
200	WSX445-200C08NR	60	32	18	135	29.3	160	25.7	14.22	4
200	WSX445-200C12NR	60	32	18	135	29.3	160	25.7	14.22	4
200	WSX445-200C20NR	60	32	18	135	29.3	160	25.7	14.22	4

FRAISES À PLAQUETTES

CONDITIONS DE COUPE RECOMMANDÉES

■ Usinage à sec

Matière	Dureté	1ère préconisation	2nde préconisation	Vc (m/min)	Finition		
					fz (mm/dent)	ap	
					Brise-copeaux L		
P					Brise-copeaux L		
Acier doux	≤ 180HB	MP6120	VP15TF	250 (200–300)	0.15 (0.1–0.2)	≤ 1.0	
		MP6130	VP20RT	240 (190–290)	0.15 (0.1–0.2)	≤ 1.0	
		MX3030	–	180 (130–230)	0.15 (0.1–0.2)	≤ 1.0	
Acier carbone Alliage acier	180–350HB	MP6120	VP15TF	220 (170–270)	0.15 (0.1–0.2)	≤ 1.0	
		MP6130	VP20RT	200 (150–250)	0.15 (0.1–0.2)	≤ 1.0	
		MX3030	–	150 (120–180)	0.15 (0.1–0.2)	≤ 1.0	
Acier outil (Recuit)	≤ 350HB	MP6120	VP15TF	220 (170–270)	0.15 (0.1–0.2)	≤ 1.0	
		MP6130	VP20RT	200 (150–250)	0.15 (0.1–0.2)	≤ 1.0	
		MX3030	–	150 (120–180)	0.15 (0.1–0.2)	≤ 1.0	
Acier pré-traité	35–45HRC	MP6120	VP15TF	140 (100–180)	0.15 (0.1–0.2)	≤ 1.0	
		MP6130	VP20RT	120 (90–150)	0.15 (0.1–0.2)	≤ 1.0	
M					Brise-copeaux L		
Acier inoxydable austénitique	≤ 200HB	MP7130	VP15TF	200 (150–250)	0.15 (0.1–0.2)	≤ 1.0	
		MP7140	VP20RT	200 (150–250)	0.15 (0.1–0.2)	≤ 1.0	
		MX3030	–	130 (100–180)	0.15 (0.1–0.2)	≤ 1.0	
Acier inoxydable austénitique	>200HB	MP7130	VP15TF	170 (120–220)	0.15 (0.1–0.2)	≤ 1.0	
		MP7140	VP20RT	170 (120–220)	0.15 (0.1–0.2)	≤ 1.0	
Acier inoxydable Duplex	≤ 280HB	MP7130	VP15TF	160 (110–210)	0.15 (0.1–0.2)	≤ 1.0	
		MP7140	VP20RT	160 (110–210)	0.15 (0.1–0.2)	≤ 1.0	
Acier inoxydable à durcissement structural	≤ 450HB	MP7130	VP15TF	150 (100–200)	0.15 (0.1–0.2)	≤ 1.0	
		MP7140	VP20RT	150 (100–200)	0.15 (0.1–0.2)	≤ 1.0	
K					Brise-copeaux L		
Fonte grise	≤ 350MPa	MC5020	–	220 (200–270)	0.15 (0.1–0.2)	≤ 1.0	
		VP15TF	–	180 (130–250)	0.15 (0.1–0.2)	≤ 1.0	
		VP20RT	–	170 (120–240)	0.15 (0.1–0.2)	≤ 1.0	
		MX3030	–	150 (120–180)	0.15 (0.1–0.2)	≤ 1.0	
Fonte ductile	≤ 450MPa	MC5020	–	200 (180–250)	0.15 (0.1–0.2)	≤ 1.0	
		VP15TF	VP20RT	160 (110–240)	0.15 (0.1–0.2)	≤ 1.0	
Fonte ductile	≤ 800MPa	MC5020	–	200 (180–250)	0.15 (0.1–0.2)	≤ 1.0	
		VP15TF	–	160 (110–240)	0.15 (0.1–0.2)	≤ 1.0	
		VP20RT	–	150 (100–200)	0.15 (0.1–0.2)	≤ 1.0	
H					Brise-copeaux M		
Acier trempé	40–55HRC	VP15TF	–	50 (30–70)	0.05 (0.05–0.1)	≤ 1.0	
Acier trempé	55–62HRC	VP15TF	–	40 (20–50)	0.05 (0.05–0.1)	≤ 1.0	

Remarque 1) Veuillez définir les conditions de coupe selon le tableau ci-dessus.

Remarque 2) Il est recommandé d'usiner sous arrosage pour obtenir de meilleurs états de surface.

(La durée de vie de l'outil est plus courte par rapport à l'usinage à sec.)

(mm)

Avance par dent **fz** (mm) et profondeur de passe **ap** (mm)

Semi-finition		Ébauche Moyenne		Ébauche		Travaux Lourds	
fz (mm/dent)	ap	fz (mm/dent)	ap	fz (mm/dent)	ap	fz (mm/dent)	ap
Brise-copeaux L,M		Brise-copeaux M		Brise-copeaux M,R		Brise-copeaux R,H	
0.15 (0.1–0.2)	≤ 2.0	0.2 (0.15–0.25)	≤ 3.0	0.2 (0.15–0.25)	≤ 4.0	0.25 (0.2–0.3)	≤ 5.0
0.15 (0.1–0.2)	≤ 2.0	0.2 (0.15–0.25)	≤ 3.0	0.2 (0.15–0.25)	≤ 4.0	0.25 (0.2–0.3)	≤ 5.0
0.15 (0.1–0.2)	≤ 2.0	0.2 (0.15–0.25)	≤ 3.0	–	–	–	–
0.15 (0.1–0.2)	≤ 2.0	0.2 (0.15–0.25)	≤ 3.0	0.2 (0.15–0.25)	≤ 4.0	0.25 (0.2–0.3)	≤ 5.0
0.15 (0.1–0.2)	≤ 2.0	0.2 (0.15–0.25)	≤ 3.0	0.2 (0.15–0.25)	≤ 4.0	0.25 (0.2–0.3)	≤ 5.0
0.15 (0.1–0.2)	≤ 2.0	0.2 (0.15–0.25)	≤ 3.0	–	–	–	–
0.15 (0.1–0.2)	≤ 2.0	0.2 (0.15–0.25)	≤ 3.0	0.2 (0.15–0.25)	≤ 4.0	0.25 (0.2–0.3)	≤ 5.0
0.15 (0.1–0.2)	≤ 2.0	0.2 (0.15–0.25)	≤ 3.0	0.2 (0.15–0.25)	≤ 4.0	0.25 (0.2–0.3)	≤ 5.0
0.15 (0.1–0.2)	≤ 2.0	0.2 (0.15–0.25)	≤ 3.0	–	–	–	–
0.15 (0.1–0.2)	≤ 2.0	0.2 (0.15–0.25)	≤ 3.0	0.2 (0.15–0.25)	≤ 4.0	0.25 (0.2–0.3)	≤ 5.0
0.15 (0.1–0.2)	≤ 2.0	0.2 (0.15–0.25)	≤ 3.0	0.2 (0.15–0.25)	≤ 4.0	0.25 (0.2–0.3)	≤ 5.0
Brise-copeaux L,M		Brise-copeaux M					
0.15 (0.1–0.2)	≤ 2.0	0.2 (0.15–0.25)	≤ 3.0	–	–	–	–
0.15 (0.1–0.2)	≤ 2.0	0.2 (0.15–0.25)	≤ 3.0	–	–	–	–
0.15 (0.1–0.2)	≤ 2.0	–	–	–	–	–	–
0.15 (0.1–0.2)	≤ 2.0	0.2 (0.15–0.25)	≤ 3.0	–	–	–	–
0.15 (0.1–0.2)	≤ 2.0	0.2 (0.15–0.25)	≤ 3.0	–	–	–	–
0.15 (0.1–0.2)	≤ 2.0	0.2 (0.15–0.25)	≤ 3.0	–	–	–	–
0.15 (0.1–0.2)	≤ 2.0	0.2 (0.15–0.25)	≤ 3.0	–	–	–	–
0.15 (0.1–0.2)	≤ 2.0	0.2 (0.15–0.25)	≤ 3.0	–	–	–	–
Brise-copeaux L,M		Brise-copeaux M		Brise-copeaux M,R		Brise-copeaux R,H	
0.15 (0.1–0.2)	≤ 2.0	0.2 (0.15–0.25)	≤ 3.0	0.2 (0.15–0.25)	≤ 4.0	0.25 (0.2–0.3)	≤ 5.0
0.15 (0.1–0.2)	≤ 2.0	0.2 (0.15–0.25)	≤ 3.0	0.2 (0.15–0.25)	≤ 4.0	0.25 (0.2–0.3)	≤ 5.0
0.15 (0.1–0.2)	≤ 2.0	0.2 (0.15–0.25)	≤ 3.0	0.2 (0.15–0.25)	≤ 4.0	0.25 (0.2–0.3)	≤ 5.0
0.15 (0.1–0.2)	≤ 2.0	0.2 (0.15–0.25)	≤ 3.0	–	–	–	–
0.15 (0.1–0.2)	≤ 2.0	0.2 (0.15–0.25)	≤ 3.0	0.2 (0.15–0.25)	≤ 4.0	0.25 (0.2–0.3)	≤ 5.0
0.15 (0.1–0.2)	≤ 2.0	0.2 (0.15–0.25)	≤ 3.0	0.2 (0.15–0.25)	≤ 4.0	0.25 (0.2–0.3)	≤ 5.0
0.15 (0.1–0.2)	≤ 2.0	0.2 (0.15–0.25)	≤ 3.0	0.2 (0.15–0.25)	≤ 4.0	0.25 (0.2–0.3)	≤ 5.0
0.15 (0.1–0.2)	≤ 2.0	0.2 (0.15–0.25)	≤ 3.0	0.2 (0.15–0.25)	≤ 4.0	0.25 (0.2–0.3)	≤ 5.0
0.15 (0.1–0.2)	≤ 2.0	0.2 (0.15–0.25)	≤ 3.0	0.2 (0.15–0.25)	≤ 4.0	0.25 (0.2–0.3)	≤ 5.0
0.15 (0.1–0.2)	≤ 2.0	0.2 (0.15–0.25)	≤ 3.0	0.2 (0.15–0.25)	≤ 4.0	0.25 (0.2–0.3)	≤ 5.0
Brise-copeaux M,R		Brise-copeaux R,H					
0.05 (0.05–0.1)	≤ 1.5	0.1 (0.05–0.15)	≤ 2.0	–	–	–	–
0.05 (0.05–0.1)	≤ 1.5	0.1 (0.05–0.15)	≤ 2.0	–	–	–	–

K

FRAISES À PLAQUETTES

FRAISES À PLAQUETTES

CONDITIONS DE COUPE RECOMMANDÉES

■ Coupe lubrifiée

Matière	Dureté	1ère préconisation	2nde préconisation	Vc (m/min)	Finition		
					fz (mm/dent)	ap	
					Brise-copeaux L		
P					Brise-copeaux L		
Acier doux	≤ 180HB	MP6120	VP15TF	150 (100–200)	0.15 (0.1–0.2)	≤ 1.0	
		MP6130	VP20RT	150 (100–200)	0.15 (0.1–0.2)	≤ 1.0	
Acier carbone Alliage acier	180–350HB	MP6120	VP15TF	120 (80–160)	0.15 (0.1–0.2)	≤ 1.0	
		MP6130	VP20RT	120 (80–160)	0.15 (0.1–0.2)	≤ 1.0	
Acier outil (Recuit)	≤ 350HB	MP6120	VP15TF	120 (80–160)	0.15 (0.1–0.2)	≤ 1.0	
		MP6130	VP20RT	120 (80–160)	0.15 (0.1–0.2)	≤ 1.0	
Acier pré-traité	35–45HRC	MP6120	VP15TF	100 (80–120)	0.15 (0.1–0.2)	≤ 1.0	
		MP6130	VP20RT	100 (80–120)	0.15 (0.1–0.2)	≤ 1.0	
M					Brise-copeaux L		
Acier inoxydable austénitique	≤ 200HB	MP7130	VP15TF	130 (80–180)	0.15 (0.1–0.2)	≤ 1.0	
		MP7140	VP20RT	130 (80–180)	0.15 (0.1–0.2)	≤ 1.0	
Acier inoxydable austénitique	> 200HB	MP7130	VP15TF	100 (80–150)	0.15 (0.1–0.2)	≤ 1.0	
		MP7140	VP20RT	100 (80–150)	0.15 (0.1–0.2)	≤ 1.0	
Acier inoxydable Duplex	≤ 280HB	MP7130	VP15TF	100 (80–150)	0.15 (0.1–0.2)	≤ 1.0	
		MP7140	VP20RT	100 (80–150)	0.15 (0.1–0.2)	≤ 1.0	
Acier inoxydable à durcissement structural	≤ 450HB	MP7130	VP15TF	90 (50–140)	0.15 (0.1–0.2)	≤ 1.0	
		MP7140	VP20RT	90 (50–140)	0.15 (0.1–0.2)	≤ 1.0	
K					Brise-copeaux L		
Fonte grise	≤ 350MPa	MC5020	–	180 (160–200)	0.15 (0.1–0.2)	≤ 1.0	
		VP15TF	VP20RT	130 (100–160)	0.15 (0.1–0.2)	≤ 1.0	
Fonte ductile	≤ 450MPa	MC5020	–	180 (160–200)	0.15 (0.1–0.2)	≤ 1.0	
		VP15TF	VP20RT	130 (100–160)	0.15 (0.1–0.2)	≤ 1.0	
Fonte ductile	≤ 800MPa	MC5020	–	180 (160–200)	0.15 (0.1–0.2)	≤ 1.0	
		VP15TF	VP20RT	110 (80–140)	0.15 (0.1–0.2)	≤ 1.0	
N					Brise-copeaux L		
Alliage aluminium	–	TF15	–	≥ 300	0.15 (0.1–0.2)	≤ 1.0	
S					Brise-copeaux L		
Alliage titane	–	MP9120	VP15TF	50 (40–60)	0.05 (0.05–0.1)	≤ 1.0	
		MP9130	VP20RT	50 (40–60)	0.05 (0.05–0.1)	≤ 1.0	
Alliage réfractaire	–	MP9120	VP15TF	40 (20–50)	0.05 (0.05–0.1)	≤ 1.0	
		MP9130	VP20RT	40 (20–50)	0.05 (0.05–0.1)	≤ 1.0	

Remarque 1) Veuillez définir les conditions de coupe selon le tableau ci-dessus.

Remarque 2) Il est recommandé d'usiner sous arrosage pour obtenir de meilleurs états de surface.

(La durée de vie de l'outil est plus courte par rapport à l'usinage à sec.)

(mm)

Avance par dent **fz** (mm) et profondeur de passe **ap** (mm)

Semi-finition		Ébauche Moyenne		Ébauche		Travaux Lourds	
fz (mm/dent)	ap	fz (mm/dent)	ap	fz (mm/dent)	ap	fz (mm/dent)	ap
Brise-copeaux L, M		Brise-copeaux M		Brise-copeaux M, R		Brise-copeaux R, H	
0.15 (0.1–0.2)	≤ 2.0	0.2 (0.15–0.25)	≤ 3.0	0.2 (0.15–0.25)	≤ 4.0	0.25 (0.2–0.3)	≤ 5.0
0.15 (0.1–0.2)	≤ 2.0	0.2 (0.15–0.25)	≤ 3.0	0.2 (0.15–0.25)	≤ 4.0	0.25 (0.2–0.3)	≤ 5.0
0.15 (0.1–0.2)	≤ 2.0	0.2 (0.15–0.25)	≤ 3.0	0.2 (0.15–0.25)	≤ 4.0	0.25 (0.2–0.3)	≤ 5.0
0.15 (0.1–0.2)	≤ 2.0	0.2 (0.15–0.25)	≤ 3.0	0.2 (0.15–0.25)	≤ 4.0	0.25 (0.2–0.3)	≤ 5.0
0.15 (0.1–0.2)	≤ 2.0	0.2 (0.15–0.25)	≤ 3.0	0.2 (0.15–0.25)	≤ 4.0	0.25 (0.2–0.3)	≤ 5.0
0.15 (0.1–0.2)	≤ 2.0	0.2 (0.15–0.25)	≤ 3.0	0.2 (0.15–0.25)	≤ 4.0	0.25 (0.2–0.3)	≤ 5.0
0.15 (0.1–0.2)	≤ 2.0	0.2 (0.15–0.25)	≤ 3.0	0.2 (0.15–0.25)	≤ 4.0	0.25 (0.2–0.3)	≤ 5.0
0.15 (0.1–0.2)	≤ 2.0	0.2 (0.15–0.25)	≤ 3.0	0.2 (0.15–0.25)	≤ 4.0	0.25 (0.2–0.3)	≤ 5.0
Brise-copeaux L, M		Brise-copeaux M					
0.15 (0.1–0.2)	≤ 2.0	0.2 (0.15–0.25)	≤ 3.0	–	–	–	–
0.15 (0.1–0.2)	≤ 2.0	0.2 (0.15–0.25)	≤ 3.0	–	–	–	–
0.15 (0.1–0.2)	≤ 2.0	0.2 (0.15–0.25)	≤ 3.0	–	–	–	–
0.15 (0.1–0.2)	≤ 2.0	0.2 (0.15–0.25)	≤ 3.0	–	–	–	–
0.15 (0.1–0.2)	≤ 2.0	0.2 (0.15–0.25)	≤ 3.0	–	–	–	–
0.15 (0.1–0.2)	≤ 2.0	0.2 (0.15–0.25)	≤ 3.0	–	–	–	–
0.15 (0.1–0.2)	≤ 2.0	0.2 (0.15–0.25)	≤ 3.0	–	–	–	–
Brise-copeaux L, M		Brise-copeaux M		Brise-copeaux M, R		Brise-copeaux R, H	
0.15 (0.1–0.2)	≤ 2.0	0.15 (0.1–0.2)	≤ 2.0	0.2 (0.15–0.25)	≤ 4.0	0.25 (0.2–0.3)	≤ 5.0
0.15 (0.1–0.2)	≤ 2.0	0.15 (0.1–0.2)	≤ 2.0	0.2 (0.15–0.25)	≤ 4.0	0.25 (0.2–0.3)	≤ 5.0
0.15 (0.1–0.2)	≤ 2.0	0.15 (0.1–0.2)	≤ 2.0	0.2 (0.15–0.25)	≤ 4.0	0.25 (0.2–0.3)	≤ 5.0
0.15 (0.1–0.2)	≤ 2.0	0.15 (0.1–0.2)	≤ 2.0	0.2 (0.15–0.25)	≤ 4.0	0.25 (0.2–0.3)	≤ 5.0
0.15 (0.1–0.2)	≤ 2.0	0.15 (0.1–0.2)	≤ 2.0	0.2 (0.15–0.25)	≤ 4.0	0.25 (0.2–0.3)	≤ 5.0
0.15 (0.1–0.2)	≤ 2.0	0.15 (0.1–0.2)	≤ 2.0	0.2 (0.15–0.25)	≤ 4.0	0.25 (0.2–0.3)	≤ 5.0
Brise-copeaux L		Brise-copeaux L		Brise-copeaux L		Brise-copeaux L	
0.15 (0.1–0.2)	≤ 2.0	0.2 (0.15–0.25)	≤ 3.0	0.2 (0.15–0.25)	≤ 4.0	0.25 (0.2–0.3)	≤ 5.0
Brise-copeaux L, M		Brise-copeaux M					
0.05 (0.05–0.1)	≤ 1.5	0.1 (0.05–0.15)	≤ 2.0	–	–	–	–
0.05 (0.05–0.1)	≤ 1.5	0.1 (0.05–0.15)	≤ 2.0	–	–	–	–
0.05 (0.05–0.1)	≤ 1.5	0.1 (0.05–0.15)	≤ 2.0	–	–	–	–
0.05 (0.05–0.1)	≤ 1.5	0.1 (0.05–0.15)	≤ 2.0	–	–	–	–

K

FRAISES À PLAQUETTES



ASX445

- P
- M
- K
- N
- S
- H

K

FRAISES À PLAQUETTES



ø50, ø63



ø > 80

Fig.1
ø50
ø63

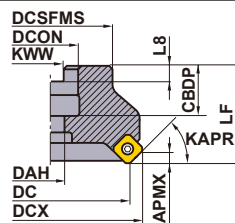

Fig.2
ø80
ø100

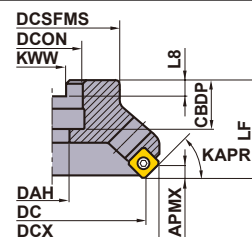

Fig.3
ø125

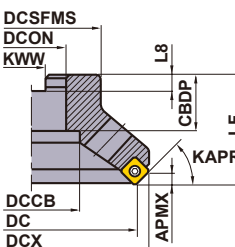

Fig.4
ø160

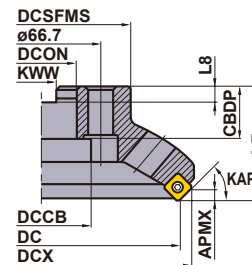
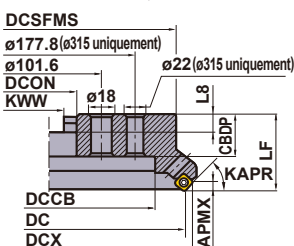

Fig.5
ø200
ø250
ø315



ATTACHEMENT PAR ALÉSAGE

KAPR : 45°

GAMP: +20° - +23° GAMF: -13° - -10°

Outil représenté à droite.

Type	Référence	Stock		Nombre de dents	Dimensions (mm)									WT* (kg)	APMX (mm)	Fig.	
		R	L		DC	DCX	LF	DCON	CBDP	DAH	DCCB	DCSFMS	KWW				L8
Pas normal	ASX445-050A03R	●		3	50	63.0	40	22	20	11	—	45	10.4	6.3	0.5	6	1
	ASX445-063A04R	●		4	63	75.9	40	22	20	11	—	50	10.4	6.3	0.7	6	1
	ASX445-080A04R	●		4	80	93.2	50	27	23	13	—	56	12.4	7	1.0	6	2
	ASX445-100A05R	●		5	100	113.2	50	32	26	17	—	70	14.4	8	1.6	6	2
	ASX445-125B06R	●		6	125	138.0	63	40	32	—	56	80	16.4	9	2.4	6	3
	ASX445-160C07R	●		7	160	173.0	63	40	29	—	56	100	16.4	9	3.9	6	4
	ASX445-200C08R	★		8	200	212.9	63	60	32	—	135	155	25.7	14.22	6.7	6	5
	ASX445-250C10R	★		10	250	262.9	63	60	32	—	174	200	25.7	14.22	10.5	6	5
	ASX445-315C14R	★		14	315	327.9	80	60	57	—	256.8	285	25.7	14.22	22.4	6	5
Pas réduit	ASX445-050A04R	●		4	50	63.0	40	22	20	11	—	45	10.4	6.3	0.4	6	1
	ASX445-063A05R	●		5	63	75.9	40	22	20	11	—	50	10.4	6.3	0.6	6	1
	ASX445-080A06R/L	●	□	6	80	93.2	50	27	23	13	—	56	12.4	7	0.9	6	2
	ASX445-100A07R/L	●	□	7	100	113.2	50	32	26	17	—	70	14.4	8	1.5	6	2
	ASX445-125B08R/L	●	□	8	125	138.0	63	40	32	—	56	80	16.4	9	2.3	6	3
	ASX445-160C10R	●		10	160	173.0	63	40	29	—	56	100	16.4	9	3.6	6	4
	ASX445-200C12R/L	●	□	12	200	212.9	63	60	32	—	135	155	25.7	14.22	5.8	6	5
	ASX445-250C14R/L	★	□	14	250	262.9	63	60	32	—	174	200	25.7	14.22	10.6	6	5
	ASX445-315C18R/L	★	□	18	315	327.9	80	60	57	—	256.8	285	25.7	14.22	22.2	6	5
Pas extra fin	ASX445-050A05R	●		5	50	63.0	40	22	20	11	—	45	10.4	6.3	0.4	6	1
	ASX445-063A06R	●		6	63	75.9	40	22	20	11	—	50	10.4	6.3	0.6	6	1
	ASX445-080A08R	●		8	80	93.2	50	27	23	13	—	56	12.4	7	0.9	6	2
	ASX445-100A10R/L	●	□	10	100	113.2	50	32	26	17	—	70	14.4	8	1.5	6	2
	ASX445-125B12R	●		12	125	138.0	63	40	32	—	56	80	16.4	9	2.3	6	3
	ASX445-160C16R	●		16	160	173.0	63	40	29	—	56	100	16.4	9	3.6	6	4
	ASX445-200C20R	★		20	200	212.9	63	60	32	—	135	155	25.7	14.22	6.5	6	5
	ASX445-250C24R	★		24	250	262.9	63	60	32	—	174	200	25.7	14.22	10.3	6	5
	ASX445-315C28R	★		28	315	327.9	80	60	57	—	256.8	285	25.7	14.22	21.8	6	5

* WT : Poids de l'outil

● : Article stocké. ★ : Article standard Japon.

□ : Article non stocké - Fabrication sur commande uniquement.

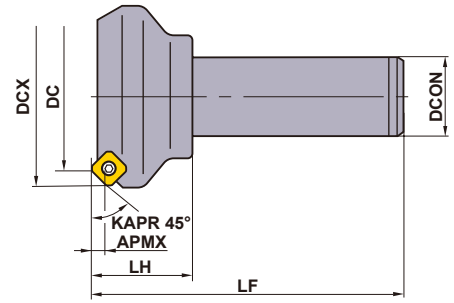
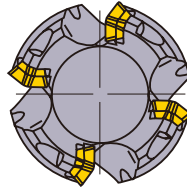

Porte-outil à droite uniquement.

ATTACHEMENT CYLINDRIQUE

Référence	Stock R	Nombre de dents	Dimensions (mm)					APMX (mm)
			DC	DCX	LF	DCON	LH	
ASX445R503S32	★	3	50	63.0	125	32	40	6
ASX445R634S32	★	4	63	75.9	125	32	40	6

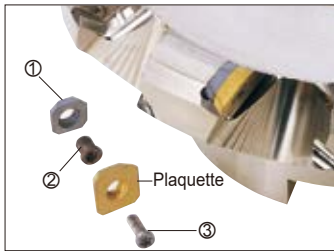

PIÈCES DÉTACHÉES

Référence porte-outil	①	②	③		
	Assise	Vis d'assise	Vis de serrage	Clé (Plaquette)	Clé (Assise)
ASX445	STASX445N	WCS503507H	TPS35	TIP15T	HKY35R

* Couple de serrage (N • m) : WCS503507H=5,0, TPS35=3,5

Clé	<p>1. Clé L'ASX445 utilise une vis de serrage TORXPLUS. La clé fournie ne peut être utilisée qu'avec cette vis. Pour garantir l'efficacité de la vis TORXPLUS, utilisez uniquement la clé fournie.</p> <p>2. Clé hexagonale La clé hexagonale fournie est réservée à l'assise. Il s'agit d'une clé de 3,5 mm</p>
Pièces détachées	Utilisez exclusivement des pièces d'origine, fournies à l'achat. L'utilisation d'autres pièces ne saurait garantir les performances et la sécurité.

PLAQUETTES DE PLANAGE

Matière	P Acier		M Acier Inoxydable		K Fonte		N Non ferreux		S Alliage réfractaire, Alliage titane		H Acier traité		Conditions de coupe (Guide) :							Géométrie
	● : Coupe Stable ● : Coupe Générale ✖ : Coupe Instable												Honing : E : Rayon F : Affûtée S : Chanfrein + Rayon T : Chanfrein							
Forme	Référence	Classe	Honing	Revêtu	Cermet	Cermet revêtu	Carbure	CBN	PCD	Dimensions (mm)						Géométrie				
				MC5020	VP15TF	NX2525	VP25N	HT105T	MB710	MD220	L	LE	W1	S	BS		RE			
	WEEW13T3AGER8C	E	E	●	●								16.6	—	16.48	3.97	7.5	1.5		
	WEEW13T3AGTR8C	E	T		●	●							16.6	—	16.48	3.97	7.5	1.5		
	WEEW13T3AGFR3C	E	F						●				16.6	1.8	16.48	3.97	3.0	1.5		
	WEEW13T3AGTR3C	E	T						●				16.6	1.8	16.48	3.97	3.0	1.5		

Remarque 1) Les plaquettes de planage possèdent une seule arête.
 Remarque 2) La nuance CBN MB710 est recommandée pour la fonte.
 Remarque 3) La nuance PCD MD220 est recommandée pour les alliages d'aluminium.

INSTRUCTIONS POUR L'UTILISATION DE PLAQUETTES DE PLANAGE



Fig.1



Fig.2

Remarque 1) Les plaquettes de planage possèdent une seule arête.
 Remarque 2) Montez la plaquette de sorte que l'arête de coupe soit positionnée selon la Fig. 1.
 N'installez pas la plaquette de planage selon la Fig. 2. (La plaquette peut être endommagée par un effort de coupe trop élevé.)
 Remarque 3) La profondeur de passe recommandée est $ap = 0,2-0,5$ mm. (Vérifier la charge à la broche en cas de profondeurs de passe supérieures.)
 Remarque 4) L'arête d'une plaquette de planage est positionnée davantage vers l'intérieur qu'une plaquette de coupe. Cela évite les efforts de coupe trop importants sur la plaquette de planage. (Régalez l'avance à une valeur inférieure à 0,2 mm/dent. afin d'éviter l'écaillage.)
 Remarque 5) Une seule plaquette de planage permet d'obtenir un état de surface excellent.
 Remarque 6) Lorsque l'avance par tour est supérieure à la largeur de l'arête de planage, installez au moins 2 plaquettes de planage à équidistance à l'intérieur du corps de fraise.

CONDITIONS DE COUPE RECOMMANDÉES AVEC PLAQUETTE DE PLANAGE

Matière	Nuance	Vitesse de coupe recommandée (m/min)
P	VP25N	200 (80–250)
	VP15TF	180 (80–250)
M	VP15TF	120–270
K	MC5020	130–250
	VP15TF	
	MB710	
S	VP15TF	20–50
H	VP15TF	40–80
N	MD220	650 (300–1000)

● La profondeur de coupe recommandée (ap) est de 0.2 à 0.5 mm avec une avance par dent (fz) de 0.2 mm/dent.

PIÈCES DÉTACHÉES > N001
 DONNÉES TECHNIQUES > P001

FRAISES À PLAQUETTES

CONDITIONS DE COUPE RECOMMANDÉES

	Matière	Dureté	Nuance	Vitesse de coupe (m/min)	Finition – Semi finition		Semi finition – Ébauche		Ébauche moyenne – Travaux lourds	
					Avance par dent (mm/dent)	Brise-copeaux	Avance par dent (mm/dent)	Brise-copeaux	Avance par dent (mm/dent)	Brise-copeaux
K FRAISES À PLAQUETTES	Acier doux	≤180HB	F7030	280 (210–350)	0.15 (0.1–0.2)	JL	0.2 (0.1–0.3)	JM	0.3 (0.2–0.4)	JH
			MP6120 VP15TF	250 (200–300)	0.15 (0.1–0.2)	JL	0.2 (0.1–0.3)	JM	0.3 (0.2–0.4)	JH
			MP6130	240 (190–290)	0.15 (0.1–0.2)	JL	0.2 (0.1–0.3)	JM	0.3 (0.2–0.4)	JH
			VP30RT	230 (180–280)	0.15 (0.1–0.2)	JL	0.2 (0.1–0.3)	JM	0.3 (0.2–0.4)	JH
			NX4545	180 (130–230)	0.15 (0.1–0.2)	JL	0.2 (0.1–0.3)	JM	–	–
	Acier carbone Alliage acier	180–280HB	F7030	250 (200–300)	0.15 (0.1–0.2)	JL	0.2 (0.1–0.3)	JM	0.3 (0.2–0.4)	JH
			MP6120 VP15TF	220 (170–270)	0.15 (0.1–0.2)	JL	0.2 (0.1–0.3)	JM	0.3 (0.2–0.4)	JH
			MP6130	200 (150–230)	0.15 (0.1–0.2)	JL	0.2 (0.1–0.3)	JM	0.3 (0.2–0.4)	JH
			VP30RT	150 (120–180)	0.15 (0.1–0.2)	JL	0.2 (0.1–0.3)	JM	0.3 (0.2–0.4)	JH
			NX4545	150 (120–180)	0.15 (0.1–0.2)	JL	0.2 (0.1–0.3)	JM	–	–
280–350HB		F7030	180 (130–230)	0.15 (0.1–0.2)	JL	0.2 (0.1–0.3)	JM	0.3 (0.2–0.4)	JH	
		MP6120 VP15TF	140 (100–180)	0.15 (0.1–0.2)	JL	0.2 (0.1–0.3)	JM	0.3 (0.2–0.4)	JH	
		MP6130	120 (90–150)	0.15 (0.1–0.2)	JL	0.2 (0.1–0.3)	JM	0.3 (0.2–0.4)	JH	
		VP30RT	100 (80–160)	0.15 (0.1–0.2)	JL	0.2 (0.1–0.3)	JM	0.3 (0.2–0.4)	JH	
		NX4545	100 (80–160)	0.15 (0.1–0.2)	JL	0.2 (0.1–0.3)	JM	–	–	
M	Acier inoxydable	≤270HB	MP7130 VP15TF	220 (170–270)	0.15 (0.1–0.2)	JL	0.2 (0.1–0.3)	JM	0.3 (0.2–0.4)	JH
			MP7140 VP30RT	200 (150–250)	0.15 (0.1–0.2)	JL	0.2 (0.1–0.3)	JM	0.3 (0.2–0.4)	JH
			NX4545	150 (120–180)	0.15 (0.1–0.2)	JL	0.2 (0.1–0.3)	JM	–	–
K	Fonte Fonte ductile	Résistance à la traction ≤450MPa	MC5020	200 (150–250)	–	–	0.2 (0.1–0.3)	JM	0.3 (0.2–0.4)	JH FT
			VP15TF	180 (130–250)	0.15 (0.1–0.2)	JL	0.2 (0.1–0.3)	JM	0.3 (0.2–0.4)	JH
		Résistance à la traction ≥450MPa	MC5020	110 (80–150)	–	–	0.2 (0.1–0.3)	JM	0.3 (0.2–0.4)	JH FT
N	Alliage aluminium	–	HTi10	650 (300–1000)	0.15 (0.1–0.2)	JP	0.2 (0.1–0.3)	JP	0.3 (0.2–0.4)	JP
S	Alliage titane	–	MP9120 VP15TF	50 (40–60)	0.15 (0.1–0.2)	JL	0.2 (0.1–0.3)	JM	0.3 (0.2–0.4)	JH
			MP9130	45 (30–55)	0.15 (0.1–0.2)	JL	0.2 (0.1–0.3)	JM	0.3 (0.2–0.4)	JH
	Alliage réfractaire (Inconel718 etc.)	–	MP9120 VP15TF	40 (20–50)	0.15 (0.1–0.2)	JL	0.2 (0.1–0.3)	JM	0.3 (0.2–0.4)	JH
			MP9130	35 (15–45)	0.15 (0.1–0.2)	JL	0.2 (0.1–0.3)	JM	0.3 (0.2–0.4)	JH
H	Acier Traité	40–55HRC	VP15TF	80 (60–100)	0.1 (0.05–0.15)	JL	0.15 (0.1–0.2)	JM	0.2 (0.1–0.3)	JH

● Régime (min⁻¹)=(1000×Vitesse de coupe)÷(3.14×DC)

● Avance table (mm/min)=Avance par dent×Nombre de dents×Régime

CARACTÉRISTIQUES

■ STABILITÉ, LONGUE DURÉE DE VIE, CORPS HAUTE PRÉCISION

<p>Le support carbure doté des propriétés Mitsubishi (AFI) Anti-Fly Insert, procure une excellente stabilité de la plaquette, et permet donc une coupe stable même dans des conditions difficiles.</p> 	<p>Le corps de fraise est réalisé avec un alliage spécial qui est robuste à haute température. Un traitement de surface spécial améliore la résistance à la corrosion.</p> 	<p>Les fraises ASX sont dotées de fixation plaquette par vis, pour un serrage simple et une grande précision du placement de la plaquette. Performances augmentées de l'indexation des plaquettes puisque le desserrage complet de la vis n'est pas nécessaire.</p> 
--	--	---

■ EFFICACES DANS UN LARGE CHOIX D'APPLICATIONS

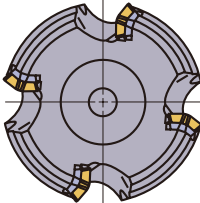
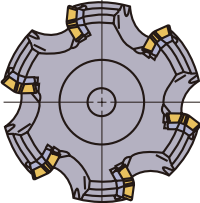
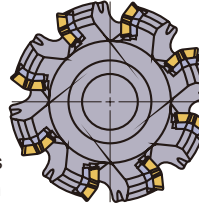
<p>● Pas large</p> <ol style="list-style-type: none"> 1. Premier choix pour la coupe des aciers et aciers inoxydables. 2. Pour les usinages profonds et les vitesses d'avance élevées avec un grand débit copeaux. 3. Coupe homogène permettant des applications avec grands porte-à-faux. 	<p>● Pas fin</p> <ol style="list-style-type: none"> 1. Premier choix pour l'usinage de la fonte, de l'acier trempé et des alliages réfractaires. 2. Pour les coupes peu profondes et les vitesses d'avance faibles avec un petit débit copeaux 	<p>● Pas extra-fin</p> <ol style="list-style-type: none"> 1. Premier choix pour l'usinage de la fonte. 2. Pour des opérations de coupe impliquant un faible débit copeaux mais avec une avance table élevée. 
---	--	--

■ LES BRISE-COPEAUX POUR UN LARGE CHOIX D'APPLICATIONS*

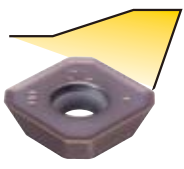
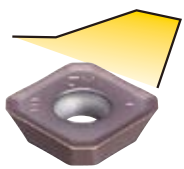
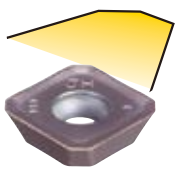
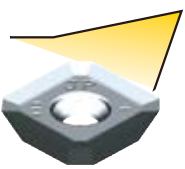
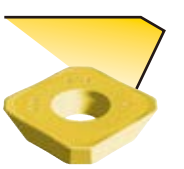
JL Brise-copeaux Finition à coupe légère	JM Brise-copeaux Coupe légère à ébauche moyenne	JH Brise-copeaux Ébauche moyenne à travaux lourds	JP Brise-copeaux Alliages aluminium	FT Brise-copeaux Ébauches fontes
				
Plaquette de grande précision, affûtée en périphérie. Angle de dépouille important pour un faible effort de coupe. ① Rigidité pièce à usiner faible.	Plaquette de précision classe M. Adaptée à un large choix de matières et de conditions de coupe. ① Coupe générale.	Plaquette de précision classe M. Arête de coupe renforcée pour une résistance importante à l'écaillage. ① Coupe interrompue. ② Écrouissage.	Plaquette de grande précision affûtée en périphérie. Angle de dépouille important et face rectifiée. Grande acuité d'arête pour de bonnes performances de coupe et résistance à l'arête rapportée. ① Usinage général de l'aluminium et des métaux non-ferreux.	Plaquettes de classe M. Plaquettes sans brise-copeaux, encore plus résistantes à l'écaillage. ① Pour l'ébauche, écrouissage des fontes.

■ NUANCES PLAQUETTES POUR LES USINAGES D'UN LARGE CHOIX DE MATIÈRES

<p>P Acier carbone · Alliage acier</p> <p>F7030</p> <p>MP6120 VP15TF</p> <p>MP6130</p> <p>VP30RT</p> <p>Stable Conditions de coupe Instable</p>	<p>M Acier inoxydable</p> <p>F7030</p> <p>MP7130 VP15TF</p> <p>MP7140 VP30RT</p> <p>Stable Conditions de coupe Instable</p>	<p>K Fonte · Fonte ductile</p> <p>MC5020</p> <p>VP15TF</p> <p>Stable Conditions de coupe Instable</p>	<p>N Alliage aluminium</p> <p>HTi10</p> <p>Stable Conditions de coupe Instable</p>	<p>S Alliage réfractaire Alliage titane</p> <p>MP9120 VP15TF</p> <p>MP9130</p> <p>Stable Conditions de coupe Instable</p>	<p>H Acier traité</p> <p>VP15TF</p> <p>Stable Conditions de coupe Instable</p>
--	--	--	---	--	---

Remarque 1) Pour l'usinage d'aciers ou aciers inoxydable où l'état de surface est important : utiliser la nuance cermet NX4545.
 Coupe Stable : Coupe continue, profondeurs de passe constantes, usinage sécurisé par un bon serrage.
 Coupe Instable : Coupe fortement interrompue, profondeurs de passe irrégulières, faible rigidité de serrage.

K
FRAISES À PLAQUETTES

Avance et profondeur de passe en fonction du nombre de dents

DC	Type	Nombre de dents	AHX440S			AHX475S			AHX640S		
			Coupe Générale			Usinage à grande avance			Coupe Générale		
			Stock	fr (mm/tour)	APMX	Stock	fr (mm/tour)	APMX	Stock	fr (mm/tour)	APMX
40	Pas réduit	3	●	0.6–1.2	3						
	Pas extra fin	4	●	0.8–1.6	3						
50	Pas réduit	4	●	0.8–1.6	3	●	2.4–4.0	1.6			
	Pas extra fin	5	●	1.0–2.0	3	●	3.0–5.0	1.6			
	Pas super extra fin	6	●	1.2–2.4	3						
63	Pas normal	4							●	0.8–1.6	6
	Pas réduit	5	●	1.0–2.0	3	●	3.0–5.0	1.6	●	1.0–2.0	6
	Pas extra fin	6	●	1.2–2.4	3	●	3.6–6.0	1.6			
80	Pas normal	4							●	0.8–1.6	6
	Pas réduit	6	●	1.2–2.4	3	●	3.6–6.0	1.6	●	1.2–2.4	6
	Pas extra fin	8	●	1.6–3.2	3	●	4.8–8.0	1.6			
100	Pas normal	5							●	1.0–2.0	6
	Pas réduit	7	●	1.4–2.8	3	●	4.2–7.0	1.6	●	1.4–2.8	6
	Pas extra fin	9				●	5.4–9.0	1.6			
125	Pas normal	6							●	1.2–2.4	6
	Pas réduit	8	●	1.6–3.2	3	●	4.8–8.0	1.6	●	1.6–3.2	6
	Pas extra fin	10				●	6.0–10.0	1.6			
	Pas super extra fin	14	●	2.8–5.6	3						
160	Pas normal	7							●	1.4–2.8	6
	Pas réduit	10	●	2.0–4.0	3	●	6.0–10.0	1.6	●	2.0–4.0	6
	Pas extra fin	12				●	7.2–12.0	1.6			
	Pas super extra fin	14	●	2.8–5.6	3						
200	Pas normal	8							●	1.6–3.2	6
	Pas réduit	12							●	2.4–4.8	6

Remarque 1) fr : L'avance par dent de l'AHX475S dépend de l'engagement ae. Cf. page K040 pour davantage de détails.)

Remarque 2) AHX440S : les profondeurs de passe maximales dépendent du brise-copeaux.

Remarque 3) Les profondeurs de passe et avances sont identiques pour les aciers carbone et alliés.

Compatibilité des plaquettes

La plaquette RE = 3,2 mm de l'AHX440S peut être montée sur l'AHX475S.

Toutes les plaquettes de l'AHX640W peuvent être montées sur l'AHX640S (veuillez noter que la hauteur de réglage sera différente).

Les plaquettes pour l'AHX640W sont les brise-copeaux MK, HK et WK.

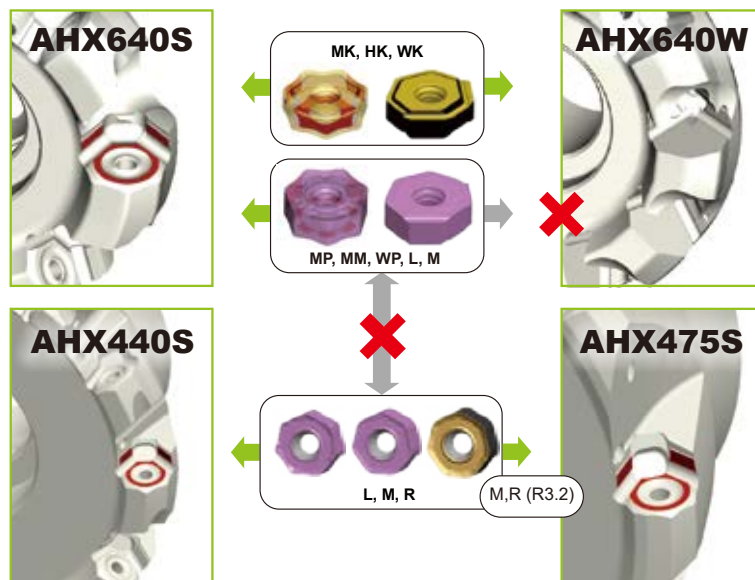

Systeme de Brise-Copeaux

Brise-copeaux selon les applications

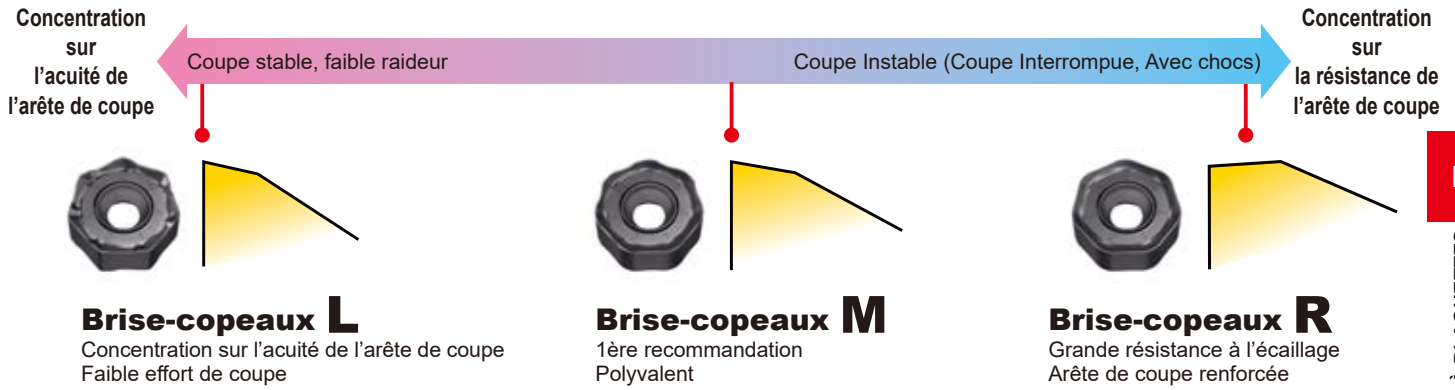

K
FRAISES À PLAQUETTES

Matière	Conditions de coupe		
	Coupe Stable	Coupe Générale	Coupe Instable
P	AHX440S L (Avec wiper) M(R0.8) (Avec wiper) M(R3.2) (Partagé avec AHX475) R (Partagé avec AHX475)	AHX640S M MP	
	M	AHX440S L (Avec wiper) M(R0.8) (Avec wiper) M(R3.2) R	
AHX640S MM			
K	AHX440S L (Avec wiper) M(R0.8) (Avec wiper) M(R3.2) (Partagé avec AHX475) R (Partagé avec AHX475)	AHX640S MK	HK

Plaquette de planage pour l'AHX640S

Selon le nombre de plaquettes de coupe et les conditions de coupe, l'utilisation de plaquettes de planage peut améliorer l'état de surface.



WP + combinaison avec **MP**
2 arêtes à droite, 2 arêtes à gauche



WK + combinaison avec **MK**
2 arêtes à droite, 2 arêtes à gauche



FRAISES À PLAQUETTES

FRAISES À SURFACER <FRAISAGE EN GÉNÉRAL>



AHX440S

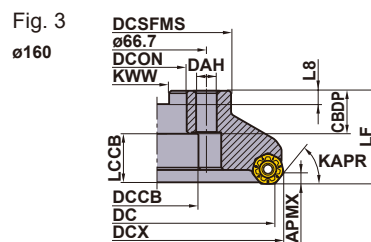
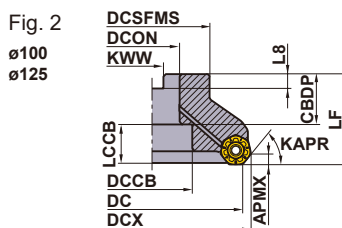
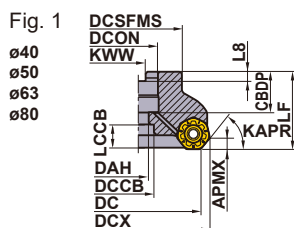

KAPR : 50°
GAMP: -6° GAMF: -7°

Outil à droite uniquement.

FRAISES À PLAQUETTES

K

DC (mm)	Référence	Stock	Trou d'arrosage	Nombre de dents	Dimensions (mm)			Fig.	WT* (kg)	APMX (mm)
					LF	DCX	DCON			
40	AHX440S-040A03AR	●	○	3	40	48.4	16	1	0.3	3
	AHX440S-040A04AR	●	○	4	40	48.4	16	1	0.2	3
50	AHX440S-050A04AR	●	○	4	40	58.4	22	1	0.4	3
	AHX440S-050A05AR	●	○	5	40	58.4	22	1	0.4	3
	AHX440S-050A06AR	●	○	6	40	58.4	22	1	0.4	3
63	AHX440S-063A05AR	●	○	5	40	71.4	22	1	0.6	3
	AHX440S-063A06AR	●	○	6	40	71.4	22	1	0.6	3
	AHX440S-063A08AR	●	○	8	40	71.4	22	1	0.5	3
80	AHX440S-080A06AR	●	○	6	50	88.4	27	1	1.1	3
	AHX440S-080A08AR	●	○	8	50	88.4	27	1	1.1	3
	AHX440S-080A10AR	●	○	10	50	88.4	27	1	1.1	3
100	AHX440S-100B07AR	●	○	7	50	108.4	32	2	1.6	3
	AHX440S-100B10AR	●	○	10	50	108.4	32	2	1.6	3
	AHX440S-100B12AR	●	○	12	50	108.3	32	2	1.6	3
125	AHX440S-125B08AR	●	○	8	63	133.4	40	2	3.0	3
	AHX440S-125B12AR	●	○	12	63	133.4	40	2	3.0	3
	AHX440S-125B14AR	●	○	14	63	133.3	40	2	2.9	3
160	AHX440S-160C10NR	●	—	10	63	168.4	40	3	4.8	3
	AHX440S-160C14NR	●	—	14	63	168.4	40	3	4.6	3
	AHX440S-160C16NR	●	—	16	63	168.4	40	3	4.7	3

Remarque 1) Les corps de fraises sont fournis sans vis d'attachement. Veuillez commander les vis d'attachement séparément.

Remarque 2) La profondeur de passe admissible APMX varie en fonction du brise-copeaux utilisé.

* WT : poids du corps

PIÈCES DÉTACHÉES

Référence porte-outil	* Vis de fixation	Clé (Plaquette)
AHX440S	TS35R	TKY15T

* Couple de serrage (N • m) : TS35R=3,5

VIS D'ATTACHEMENT (VENDUE SÉPARÉMENT)

Référence porte-outil	Vis d'attachement		Fig.	Dimensions (mm)							Géométrie
	Avec trou d'arrosage	Sans trou d'arrosage		a	b	c	d	e	f	g	
	Référence	Référence									
AHX440S-040A○○AR	HSC08025H	HSC08040	1	13	M8×1.25	33	8	5	—	—	Fig.1
AHX440S-050A○○AR	HSC10030H	HSC10035	1	16	M10×1.5	40	10	6	—	—	
AHX440S-063A○○AR	HSC10030H	HSC10035	1	16	M10×1.5	40	10	6	—	—	
AHX440S-080A○○AR	HSC12035H	HSC12035 (HSC12045)	1	18	M12×1.75	47 57	12	10	—	—	Fig.2
AHX440S-100B○○AR	MBA16033H	—	2	40	M16×2	43	10	14	6	23	
AHX440S-125B○○AR	MBA20040H	—	2	50	M20×2.5	54	14	17	6	27	
AHX440S-160C○○NR	Sans trous d'arrosage		2	50	M20×2.5	54	14	17	6	27	

Remarque 1) Une vis percée spécifique est nécessaire pour utiliser l'arrosage interne.

● : Article stocké. ★ : Article standard Japon.

PLAQUETTES

Matière		P	Acier		Conditions de coupe (Guide) :					Honing :						
		M	Acier Inoxydable		● : Coupe Stable ⦿ : Coupe Générale ⚡ : Coupe Instable					E : Ronde						
K	Fonte															
H	Acier trempé															
Application	Forme	Référence	Classe	Honing	Revêtu						Dimensions (mm)					Géométrie
					MP6120	MP6130	MP7130	MP7140	MC5020	VP15TF	IC	RE	BS	S	APMX	
Coupe Stable		NNMU130508ZER-L	M	E	●	●	●	●	●	★	13.4	0.8	1	5.77	3	
Coupe Générale		NNMU130508ZEN-M	M	E	●	●	●	●	●	★	13.4	0.8	1	5.57	* 4	
Coupe Instable		NNMU130532ZEN-M	M	E	●	●	●	●	●	★	13.4	3.2	—	5.57	* 4	
Finition		NNMU130532ZEN-R	M	E	●	●	●	●	●	★	13.4	3.2	—	5.47	* 4	
		WNEU1305ZEN4C-M	E	E	●					★	13.4	2.7	4	5.1	0.5	

* Si le rayon de bec adjaçant n'est pas utilisé, APMX = 3.5mm



Rayon de bec adjaçant

En cas d'utilisation du rayon de bec adjaçant, APMX = 4,0 mm
 En cas de non-utilisation du rayon de bec adjaçant, APMX = 3,5 mm

INSTRUCTIONS POUR L'UTILISATION DES PLAQUETTES DE PLANAGE

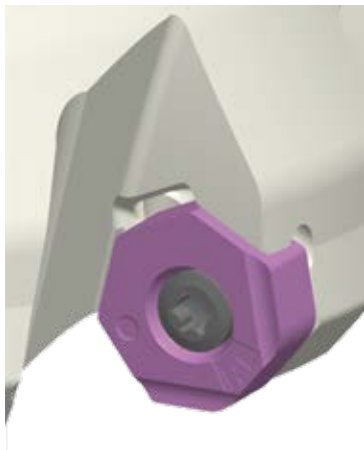

Fig.1



Fig.2

Remarque 1) Les plaquettes de planages comprennent 2 arêtes de coupe à droite et 2 arêtes à gauche. Reportez-vous à la figure 1.

Remarque 2) Une seule plaquette de planage permet d'obtenir un état de surface satisfaisant.

Toutefois, si l'avance par tour est égale ou supérieure à la largeur de l'arête de planage, il est recommandé d'installer plusieurs plaquettes de planage en les espaçant de façon régulière sur la fraise.

FRAISES À PLAQUETTES

CONDITIONS DE COUPE RECOMMANDÉES

■ Usinage à sec

Matière	Dureté	Nuance	Vc (m/min)	fz (mm/dent)	ap (mm)	
P	Acier doux	MP6120,VP15TF	250(200–300)	0.3(0.2–0.4)	≤3	
		MP6130	240(190–290)	0.3(0.2–0.4)	≤3	
	Acier carbone, Alliage acier	MP6120,VP15TF	220(170–270)	0.3(0.2–0.4)	≤3	
		MP6130	200(150–250)	0.3(0.2–0.4)	≤3	
	Acier carbone, Alliage acier	MP6120,VP15TF	140(100–180)	0.3(0.2–0.4)	≤3	
		MP6130	120(90–150)	0.3(0.2–0.4)	≤3	
	Acier outil (recuit)	MP6120,VP15TF	140(100–180)	0.15(0.1–0.2)	≤1	
		MP6130	120(90–150)	0.15(0.1–0.2)	≤1	
	Acier pré-traité	35–45HRC	MP6120,VP15TF	140(100–180)	0.15(0.1–0.2)	≤1
			MP6130	120(90–150)	0.15(0.1–0.2)	≤1
M	Acier inoxydable austénitique	≤200HB	MP7130,VP15TF	200(150–250)	0.2(0.1–0.3)	≤3
			MP7140	180(120–230)	0.2(0.1–0.3)	≤3
		> 200HB	MP7130,VP15TF	150(100–200)	0.2(0.1–0.3)	≤3
			MP7140	130(80–180)	0.2(0.1–0.3)	≤3
	Aciers inoxydables austénitiques et martensitiques	≤200HB	MP7130,VP15TF	200(150–250)	0.2(0.1–0.3)	≤3
			MP7140	180(120–230)	0.2(0.1–0.3)	≤3
		> 200HB	MP7130,VP15TF	150(100–200)	0.2(0.1–0.3)	≤3
			MP7140	130(80–180)	0.2(0.1–0.3)	≤3
	Acier inoxydable Duplex	≤280HB	MP7130,VP15TF	140(100–180)	0.15(0.05–0.25)	≤3
			MP7140	120(80–160)	0.15(0.05–0.25)	≤3
	Acier inoxydable à durcissement structural	< 450HB	MP7130,VP15TF	130(100–160)	0.15(0.05–0.25)	≤3
			MP7140	110(80–140)	0.15(0.05–0.25)	≤3
K	Fonte grise	Résistance à la traction ≤350MPa	MC5020	220(150–300)	0.3(0.2–0.4)	≤3
			VP15TF	180(130–230)	0.3(0.2–0.4)	≤3
	Fonte ductile	Résistance à la traction ≤450MPa	MC5020	200(150–250)	0.2(0.1–0.3)	≤3
			VP15TF	170(120–220)	0.2(0.1–0.3)	≤3
	Fonte ductile	Résistance à la traction ≤800MPa	MC5020	170(150–200)	0.2(0.1–0.3)	≤3
			VP15TF	140(100–180)	0.2(0.1–0.3)	≤3
H	Acier traité	40–55HRC	VP15TF	80(60–100)	0.15(0.1–0.2)	≤1

■ Coupe lubrifiée

Matière	Dureté	Nuance	Vc (m/min)	fz (mm/dent)	ap (mm)	
M	Acier inoxydable austénitique	≤200HB	MP7130,VP15TF	125(100–150)	0.15(0.1–0.2)	≤3
			MP7140	100(80–140)	0.15(0.1–0.2)	≤3
		> 200HB	MP7130,VP15TF	100(75–125)	0.15(0.1–0.2)	≤3
			MP7140	80(55–105)	0.15(0.1–0.2)	≤3
	Aciers inoxydables austénitiques et martensitiques	≤200HB	MP7130,VP15TF	125(100–150)	0.15(0.1–0.2)	≤3
			MP7140	100(80–140)	0.15(0.1–0.2)	≤3
		> 200HB	MP7130,VP15TF	100(75–125)	0.15(0.1–0.2)	≤3
			MP7140	80(55–105)	0.15(0.1–0.2)	≤3
	Acier inoxydable Duplex	≤280HB	MP7130,VP15TF	80(60–100)	0.1(0.05–0.15)	≤3
			MP7140	60(40–80)	0.1(0.05–0.15)	≤3
	Acier inoxydable à durcissement structural	< 450HB	MP7130,VP15TF	70(50–90)	0.1(0.05–0.15)	≤3
			MP7140	50(30–70)	0.1(0.05–0.15)	≤3

■ Conditions de coupe avec plaquette de planage

	Matière	Dureté	Nuance	Vc (m/min)	fz (mm/dent)	ap (mm)
P	Acier doux	≤180HB	MP6120,VP15TF	250(200–300)	0.3(0.2–0.4)	≤0.5
	Acier carbone, Alliage acier	180–280HB	MP6120,VP15TF	220(170–270)	0.3(0.2–0.4)	≤0.5
		280–350HB	MP6120,VP15TF	140(100–180)	0.3(0.2–0.4)	≤0.5
	Acier outil	≤350HB (recuit)	MP6120,VP15TF	140(100–180)	0.15(0.1–0.2)	≤0.5
	Acier pré-traité	35–45HRC	MP6120,VP15TF	140(100–180)	0.15(0.1–0.2)	≤0.5
M	Acier inoxydable austénitique	≤200HB	VP15TF	125(100–150)	0.15(0.1–0.2)	≤0.5
		> 200HB	VP15TF	100(75–125)	0.15(0.1–0.2)	≤0.5
	Aciers inoxydables austénitiques et martensitiques	≤200HB	VP15TF	125(100–150)	0.15(0.1–0.2)	≤0.5
		> 200HB	VP15TF	100(75–125)	0.15(0.1–0.2)	≤0.5
	Acier inoxydable Duplex	≤280HB	VP15TF	80(60–100)	0.1(0.05–0.15)	≤0.5
	Acier inoxydable à durcissement structural	< 450HB	VP15TF	70(50–90)	0.1(0.05–0.15)	≤0.5
K	Fonte grise	Résistance à la traction ≤350MPa	MC5020	320(250–400)	0.3(0.2–0.4)	≤0.5
			VP15TF	220(150–300)	0.3(0.2–0.4)	≤0.5
	Fonte ductile	Résistance à la traction ≤450MPa	MC5020	250(200–300)	0.2(0.1–0.3)	≤0.5
			VP15TF	200(150–250)	0.2(0.1–0.3)	≤0.5
		Résistance à la traction ≤800MPa	MC5020	220(200–250)	0.2(0.1–0.3)	≤0.5
			VP15TF	170(150–200)	0.2(0.1–0.3)	≤0.5
H	Acier traité	40–55HRC	VP15TF	80(60–100)	0.15(0.1–0.2)	≤0.5

Remarque 1) Veuillez vous reporter au tableau ci-dessus pour les conditions de coupe.

Remarque 2) Il est recommandé d'usiner sous arrosage pour obtenir de meilleurs états de surface.

(La durée de vie de l'outil est plus courte par rapport à l'usinage à sec.)

Remarque 3) La profondeur de passe recommandée varie en fonction de la géométrie de plaquette.

Remarque 4) Pour l'usinage d'une pièce de faible raideur ou avec des porte-à-faux importants, nous recommandons de réduire les vitesses de coupe et d'avance de 30 %.

Remarque 5) Pour obtenir un bon état de surface de l'acier inoxydable, la coupe lubrifiée est recommandée. (La durée de vie de l'outil en coupe lubrifiée est courte par rapport à la coupe à sec.)

K

FRAISES À PLAQUETTES

FRAISES À PLAQUETTES

FRAISES À SURFACER

<FRAISE À SURFACER À GRANDE AVANCE>

15°
KAPR



AHX475S

P M **K** N S H



Fig.1

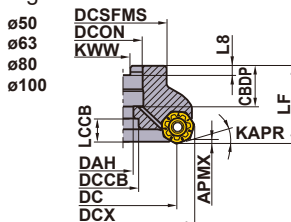
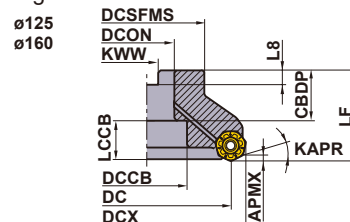

Fig.2



Porte-outil à droite uniquement.

FRAISES À PLAQUETTES

K

KAPR : 15°



GAMP: -6° GAMF: -10°

DC (mm)	Référence	Stock	Trou d'arrosage	Nombre de dents	Dimensions (mm)			Fig.	WT [*] (kg)	APMX (mm)
					LF	DCX	DCON			
50	AHX475S-050A04AR	●	○	4	50	65.7	22	1	0.6	1.6
	AHX475S-050A05AR	●	○	5	50	65.7	22	1	0.6	1.6
63	AHX475S-063A05AR	●	○	5	50	78.7	22	1	1.0	1.6
	AHX475S-063A06AR	●	○	6	50	78.7	22	1	1.0	1.6
80	AHX475S-080A06AR	●	○	6	50	95.6	27	1	1.6	1.6
	AHX475S-080A08AR	●	○	8	50	95.6	27	1	1.6	1.6
100	AHX475S-100A07AR	●	○	7	63	115.6	32	1	3.3	1.6
	AHX475S-100A09AR	●	○	9	63	115.6	32	1	3.3	1.6
125	AHX475S-125B08AR	●	○	8	63	140.6	40	2	4.0	1.6
	AHX475S-125B10AR	●	○	10	63	140.6	40	2	4.0	1.6
160	AHX475S-160B10AR	●	○	10	63	175.6	40	2	6.0	1.6
	AHX475S-160B12AR	●	○	12	63	175.6	40	2	6.0	1.6

Remarque 1) Le corps de fraise est livré sans vis de fixation pour l'axe.

* WT : Poids de l'outil

PIÈCES DÉTACHÉES

Référence porte-outil	 *	
	Vis de fixation	Clé (Plaquette)
AHX475S	TS35R	TKY15T

* Couple de serrage TSR35R : 3,5 Nm

● : Article stocké. ★ : Article standard Japon.

(10 plaquettes par boîte)

VIS D'ATTACHEMENT (VENDUE SÉPARÉMENT)

Référence porte-outil	Vis d'attache		Fig.	Dimensions (mm)							Géométrie
	Avec trou d'arrosage	Sans trou d'arrosage		a	b	c	d	e	f	g	
	Référence	Référence									
AHX475S-050A [○] [○] AR	HSC10030H	HSC10035	1	16	M10×1.5	40	10	6	-	-	
AHX475S-063A [○] [○] AR	HSC10030H	HSC10035	1	16	M10×1.5	40	10	6	-	-	
AHX475S-080A [○] [○] AR	HSC12035H	HSC12035 (HSC12045)	1	18	M12×1.75	47 57	12	10	-	-	
AHX475S-100B [○] [○] AR	HSC16040H	-	1	24	M16×2	56	16	14	-	-	
AHX475S-125B [○] [○] AR	MBA20040H	-	2	50	M20×2.5	54	14	17	6	27	
AHX475S-160C [○] [○] AR	MBA20040H	-	2	50	M20×2.5	54	14	17	6	27	

Remarque 1) Une vis percée spécifique est nécessaire pour utiliser l'arrosage interne.

K

FRAISES À PLAQUETTES

PLAQUETTES

Matière		P	Acier	+	+	+	+	+	+	+	Conditions de coupe (Guide) :						
		K	Fonte								●	●	+	+	+		
		H	Acier traité								Honing : E : Ronde						
Application	Forme	Référence	Classe	Honing	Revêtu					Dimensions (mm)					Géométrie		
					MP6120	MP6130	MC5020	VP15TF			IC	RE	BS	S		APMX	
Coupe Générale		NNMU130532ZEN-M	M	E	●	●	●	★				13.4	3.2	-	5.57	1.6	
Coupe Instable		NNMU130532ZEN-R	M	E	●	●	●	★				13.4	3.2	-	5.47	1.6	

FRAISES À PLAQUETTES

CONDITIONS DE COUPE RECOMMANDÉES

■ Usinage à sec

Matière	Dureté	Nuance	Brise copeaux	Vc (m/min)	fz (mm/dent)	ap (mm)	ae (mm)	
P	Acier doux	≤180HB	MP6120	R	150(100–200)	0.6	≤1.6	≤0.5DC
			MP6120	R	150(100–200)	0.8	≤1.6	0.5–0.8DC
			MP6120	M	150(100–200)	1	≤1.6	0.8–1DC
			MP6130	R	130(80–180)	0.6	≤1.6	≤0.5DC
			MP6130	R	130(80–180)	0.8	≤1.6	0.5–0.8DC
			MP6130	M	130(80–180)	1	≤1.6	0.8–1DC
	Acier carbone, Alliage acier	180–280HB	MP6120	R	130(80–180)	0.6	≤1.6	≤0.5DC
			MP6120	R	130(80–180)	0.8	≤1.6	0.5–0.8DC
			MP6120	M	130(80–180)	1	≤1.6	0.8–1DC
			MP6130	R	110(60–160)	0.6	≤1.6	≤0.5DC
			MP6130	R	110(60–160)	0.8	≤1.6	0.5–0.8DC
			MP6130	M	110(60–160)	1	≤1.6	0.8–1DC
	Acier carbone, Alliage acier	280–350HB	MP6120	R	100(50–150)	0.5	≤1.6	≤0.5DC
			MP6120	R	100(50–150)	0.6	≤1.6	0.5–0.8DC
			MP6120	R	100(50–150)	0.7	≤1.6	0.8–1DC
			MP6130	R	80(30–130)	0.5	≤1.6	≤0.5DC
			MP6130	R	80(30–130)	0.6	≤1.6	0.5–0.8DC
			MP6130	R	80(30–130)	0.7	≤1.6	0.8–1DC
	Acier outil	≤350HB (recuit)	MP6120	R	100(50–150)	0.5	≤1.6	≤0.5DC
			MP6120	R	100(50–150)	0.6	≤1.6	0.5–0.8DC
			MP6120	R	100(50–150)	0.7	≤1.6	0.8–1DC
			MP6130	R	80(30–120)	0.5	≤1.6	≤0.5DC
			MP6130	R	80(30–120)	0.6	≤1.6	0.5–0.8DC
			MP6130	R	80(30–120)	0.7	≤1.6	0.8–1DC
Acier pré-traité	35–45HRC	MP6120	R	100(70–130)	0.5	≤1.6	≤0.5DC	
		MP6120	R	100(70–130)	0.6	≤1.6	0.5–0.8DC	
		MP6120	R	100(70–130)	0.7	≤1.6	0.8–1DC	
		MP6130	R	80(50–110)	0.5	≤1.6	≤0.5DC	
		MP6130	R	80(50–110)	0.6	≤1.6	0.5–0.8DC	
		MP6130	R	80(50–110)	0.7	≤1.6	0.8–1DC	
K	Fonte grise	Résistance à la traction ≤350MPa	MC5020	R	150(100–200)	0.6	≤1.6	≤0.5DC
			MC5020	R	150(100–200)	0.8	≤1.6	0.5–0.8DC
			MC5020	M	150(100–200)	1	≤1.6	0.8–1DC
			VP15TF	M	120(80–160)	0.6	≤1.6	≤0.5DC
			VP15TF	M	120(80–160)	0.8	≤1.6	0.5–0.8DC
			VP15TF	M	120(80–160)	1	≤1.6	0.8–1DC
	Fonte ductile	Résistance à la traction ≤450MPa	MC5020	R	150(100–200)	0.6	≤1.6	≤0.5DC
			MC5020	R	150(100–200)	0.8	≤1.6	0.5–0.8DC
			MC5020	M	150(100–200)	1	≤1.6	0.8–1DC
			VP15TF	R	120(80–160)	0.6	≤1.6	≤0.5DC
			VP15TF	R	120(80–160)	0.8	≤1.6	0.5–0.8DC
			VP15TF	M	120(80–160)	1	≤1.6	0.8–1DC
	Fonte ductile	Résistance à la traction ≤800MPa	MC5020	R	150(100–200)	0.5	≤1.6	≤0.5DC
			MC5020	R	150(100–200)	0.6	≤1.6	0.5–0.8DC
			MC5020	R	150(100–200)	0.7	≤1.6	0.8–1DC
			VP15TF	R	120(80–160)	0.5	≤1.6	≤0.5DC
			VP15TF	R	120(80–160)	0.6	≤1.6	0.5–0.8DC
			VP15TF	R	120(80–160)	0.7	≤1.6	0.8–1DC
H	Acier traité	40–55HRC	VP15TF	R	70(50–90)	0.4	≤1.6	≤0.5DC
			VP15TF	R	70(50–90)	0.5	≤1.6	0.5–0.8DC
			VP15TF	R	70(50–90)	0.6	≤1.6	0.8–1DC

Remarque 1) Pour l'usinage d'une pièce de faible raideur ou avec des porte-à-faux importants, nous recommandons de réduire les vitesses de coupe et d'avance de 30 %

FRAISES À SURFACER

<FRAISAGE EN GÉNÉRAL>

50°
KAPR



AHX640S

P M K N S H



Fig. 1
ø63
ø80

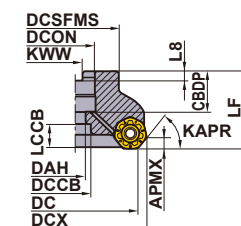

Fig. 2
ø100
ø125

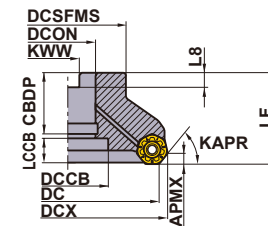

Fig. 3
ø160

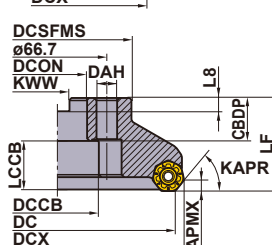
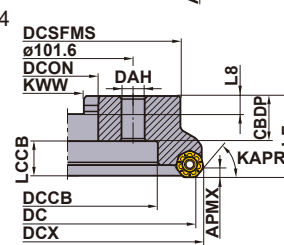

Fig. 4
ø200



Porte-outil à droite uniquement.

DC	Vis d'attachement	Géométrie
ø63	HSC10030H	
ø80	HSC12035H	
ø100	MBA16033H	
ø125	MBA20040H	
ø160	—	—
ø200	—	—

KAPR : 50°
GAMP : -6° GAMF : -5°

DC (mm)	Référence	Stock	Trou d'arrosage	Nombre de dents	Dimensions (mm)			Fig.	WT* (kg)	APMX (mm)
					LF	DCX	DCON			
63	AHX640S-063A04AR	●	○	4	50	75.55	22	1	0.7	6
	AHX640S-063A05AR	●	○	5	50	75.55	22	1	0.6	6
80	AHX640S-080A04AR	●	○	4	50	92.55	27	1	1.1	6
	AHX640S-080A06AR	●	○	6	50	92.55	27	1	1.0	6
100	AHX640S-100B05AR	●	○	5	50	112.55	32	2	1.7	6
	AHX640S-100B07AR	●	○	7	50	112.55	32	2	1.6	6
125	AHX640S-125B06AR	●	○	6	63	137.55	40	2	3.1	6
	AHX640S-125B08AR	●	○	8	63	137.55	40	2	3.0	6
160	AHX640S-160C07NR	●	—	7	63	172.55	40	3	5.4	6
	AHX640S-160C10NR	●	—	10	63	172.55	40	3	5.2	6
200	AHX640S-200C08NR	●	—	8	63	212.55	60	4	7.8	6
	AHX640S-200C12NR	●	—	12	63	212.55	60	4	7.5	6

* WT : Poids de l'outil

PIÈCES DÉTACHÉES

Référence porte-outil	 Vis de fixation	 Clé (Plaquette)
AHX640S	CS5015060T	TKY20T

* Couple de serrage CS5015060T : 5,0 Nm

● : Article stocké.

DIMENSIONS DE MONTAGE > K046
PIÈCES DÉTACHÉES > N001
DONNÉES TECHNIQUES > P001

K041











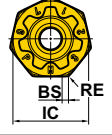
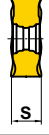

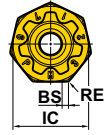
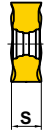

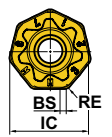

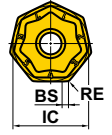
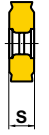
K
FRAISES À PLAQUETTES

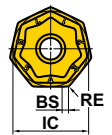
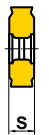
FRAISES À PLAQUETTES

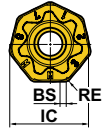
PLAQUETTES

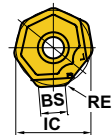
K

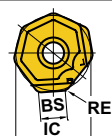
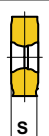
FRAISES À PLAQUETTES

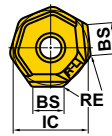
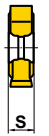
Application	Forme	Référence	Classe	Honing	Revêtu								Dimensions (mm)					Géométrie	
					MP6120	MP6130	MP7030	MP9120	MP9130	MC5020	VP15TF	VP20RT	IC	RE	BS	S	APMX		
Matière	P	Acier			●	✦												Conditions de coupe (Guide) : ● : Coupe Stable ● : Coupe Générale ✦ : Coupe Instable Honing : E : Ronde	
	M	Acier Inoxydable					●												
	K	Fonte																	
	N	Non ferreux																	
	S	Alliage réfractaire, Alliage titane																	
H	Acier traité																		
Pour Acier Coupe Générale		NNMU200708ZEN-M	M	E	●	●												 	
Pour Acier Coupe Générale		NNMU200708ZEN-MP	M	E														 	
Pour Acier inoxydable		NNMU200712ZER-MM	M	E		●												 	
Pour Fonte Coupe Générale		NNMU200608ZEN-MK	M	E						●	★	★						 	
Pour Fonte Arête de coupe renforcée		NNMU200608ZEN-HK	M	E						●	★	★						 	
Pour alliages de titane et réfractaires		NNMU200712ZER-L	M	E		●	●											 	
Pour Acier Planage		WNEU2007ZEN7C-M	E	E	●													 	
Coupe Générale Planage		WNEU2007ZEN7C-WP	E	E														 	
Pour Fonte Planage		WNEU2006ZEN7C-WK	E	E														 	

Remarque 1) La hauteur de fraise est différente si vous utilisez des plaquettes MK, HK ou des plaquettes MP, MM.

● : Article stocké. ★ : Article standard Japon.
(10 plaquettes par boîte)

■ INSTRUCTIONS POUR L'UTILISATION DES PLAQUETTES DE PLANAGE

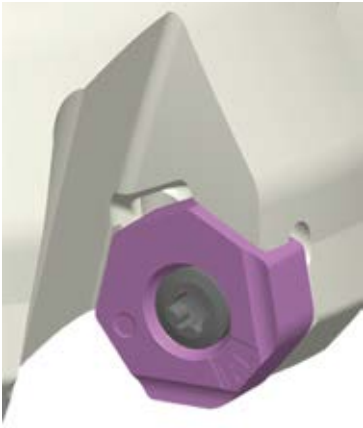

Fig.1



Fig.2

Remarque 1) Les plaquettes de planages comprennent 2 arêtes de coupe à droite et 2 arêtes à gauche. Reportez-vous à la figure 1.

Remarque 2) Une seule plaquette de planage permet d'obtenir un état de surface satisfaisant.

Toutefois, si l'avance par tour est égale ou supérieure à la largeur de l'arête de planage, il est recommandé d'installer plusieurs plaquettes de planage en les espaçant de façon régulière sur la fraise.

FRAISES À PLAQUETTES

CONDITIONS DE COUPE RECOMMANDÉES

■ Usinage à sec

Matière	Dureté	Nuance	Briscopeaux	Vc (m/min)	fz (mm/dent)	ap (mm)	ae (mm)	
P	Acier doux	MP6120	M	250 (200–300)	0.3 (0.2–0.4)	≤5	≤0.8DC	
		VP15TF	MP	250 (200–300)	0.3 (0.2–0.4)	≤5	≤0.8DC	
		MP6130	M	220 (170–270)	0.4 (0.3–0.5)	≤5	≤0.8DC	
	Acier carbone, Alliage acier	180–280HB	MP6120	M	220 (170–270)	0.3 (0.2–0.4)	≤5	≤0.8DC
			VP15TF	MP	220 (170–270)	0.3 (0.2–0.4)	≤5	≤0.8DC
			MP6130	M	190 (140–240)	0.4 (0.3–0.5)	≤5	≤0.8DC
	Acier carbone, Alliage acier	280–350HB	MP6120	M	140 (100–180)	0.3 (0.2–0.4)	≤5	≤0.8DC
			VP15TF	MP	140 (100–180)	0.3 (0.2–0.4)	≤5	≤0.8DC
			MP6130	M	110 (70–150)	0.4 (0.3–0.5)	≤5	≤0.8DC
Acier pré-traité	≤350HB (recuit)	MP6120	M	140 (100–180)	0.15 (0.1–0.2)	≤3	≤0.8DC	
		VP15TF	MP	140 (100–180)	0.15 (0.1–0.2)	≤3	≤0.8DC	
		MP6130	M	110 (70–150)	0.25 (0.2–0.3)	≤3	≤0.8DC	
Acier outil	35–45HRC	MP6120	M	140 (100–180)	0.15 (0.1–0.2)	≤3	≤0.8DC	
		VP15TF	MP	140 (100–180)	0.15 (0.1–0.2)	≤5	≤0.8DC	
		MP6130	M	110 (70–150)	0.25 (0.2–0.3)	≤3	≤0.8DC	
M	Acier inoxydable austénitique	≤200HB	MP7030	MM	200 (150–250)	0.2 (0.1–0.3)	≤5	≤0.8DC
	Acier inoxydable austénitique	> 200HB	MP7030	MM	150 (100–200)	0.2 (0.1–0.3)	≤5	≤0.8DC
	Acier inoxydable Duplex	≤280HB	MP7030	MM	140 (100–180)	0.15 (0.05–0.25)	≤5	≤0.8DC
	Aciers inoxydables austénitiques et martensitiques	≤200HB	MP7030	MM	200 (150–250)	0.2 (0.1–0.3)	≤5	≤0.8DC
	Aciers inoxydables austénitiques et martensitiques	> 200HB	MP7030	MM	150 (100–200)	0.2 (0.1–0.3)	≤5	≤0.8DC
	Acier inoxydable à durcissement structural	< 450HB	MP7030	MM	130 (100–160)	0.15 (0.05–0.25)	≤5	≤0.8DC
K	Fonte grise	Résistance à la traction ≤350MPa	MC5020	MK, HK	220 (150–300)	0.3 (0.2–0.4)	≤5	≤0.8DC
			VP15TF, VP20RT	MK, HK	180 (130–230)	0.3 (0.2–0.4)	≤5	≤0.8DC
			VP15TF	MP	180 (130–230)	0.3 (0.2–0.4)	≤5	≤0.8DC
	Fonte ductile	Résistance à la traction ≤450MPa	MC5020	MK, HK	200 (150–250)	0.2 (0.1–0.3)	≤5	≤0.8DC
			VP15TF, VP20RT	MK, HK	170 (120–220)	0.2 (0.1–0.3)	≤5	≤0.8DC
			VP15TF	MP	170 (120–220)	0.2 (0.1–0.3)	≤5	≤0.8DC
	Fonte ductile	Résistance à la traction ≤800MPa	MC5020	MK, HK	170 (150–200)	0.2 (0.1–0.3)	≤5	≤0.8DC
			VP15TF, VP20RT	MK, HK	140 (100–180)	0.2 (0.1–0.3)	≤5	≤0.8DC
			VP15TF	MP	140 (100–180)	0.2 (0.1–0.3)	≤5	≤0.8DC
H	Acier trempé	40–55HRC	VP15TF	MP	80 (60–100)	0.15 (0.1–0.2)	≤3	≤0.8DC

Remarque 1) Pour obtenir un bon état de surface de l'acier inoxydable, la coupe lubrifiée est recommandée.

(La durée de vie de l'outil est plus courte par rapport à la coupe à sec.)

Remarque 2) Nous recommandons la coupe lubrifiée avec arrosage interne pour les alliages de titane et réfractaires.

Remarque 3) Lorsque la raideur du collier est faible ou que les porte-à-faux sont importants, nous recommandons de réduire les vitesses de coupe et d'avance de 30 %.

■ Coupe lubrifiée

	Matière	Dureté	Briscopeaux	Nuance	Vc (m/min)	fz (mm/dent)	ap (mm)	ae (mm)
M	Acier inoxydable austénitique	≤200HB	MP7030	MM	125 (100–150)	0.15 (0.1–0.2)	≤5	≤0.8DC
	Acier inoxydable austénitique	> 200HB	MP7030	MM	100 (75–125)	0.15 (0.1–0.2)	≤5	≤0.8DC
	Acier inoxydable Duplex	≤280HB	MP7030	MM	80 (60–100)	0.1 (0.05–0.15)	≤5	≤0.8DC
	Aciers inoxydables austénitiques et martensitiques	≤200HB	MP7030	MM	125 (100–150)	0.15 (0.1–0.2)	≤5	≤0.8DC
	Aciers inoxydables austénitiques et martensitiques	> 200HB	MP7030	MM	100 (75–125)	0.15 (0.1–0.2)	≤5	≤0.8DC
	Acier inoxydable à durcissement structural	< 450HB	MP7030	MM	70 (50–90)	0.1 (0.05–0.15)	≤5	≤0.8DC
S	Alliage titane	–	MP7030	MM	40 (20–50)	0.15 (0.1–0.2)	≤3	≤0.6DC
		–	MP9120	L	60 (50–70)	0.1 (0.05–0.15)	≤3	≤0.6DC
		–	MP9130	L	40 (20–50)	0.15 (0.1–0.2)	≤3	≤0.6DC
	Alliage réfractaire	–	MP7030	MM	40 (20–50)	0.15 (0.1–0.2)	≤3	≤0.6DC
		–	MP9120	L	40 (20–50)	0.15 (0.1–0.2)	≤3	≤0.6DC
		–	MP9130	L	40 (20–50)	0.15 (0.1–0.2)	≤3	≤0.6DC

Remarque 1) Pour obtenir un bon état de surface de l'acier inoxydable, la coupe lubrifiée est recommandée.

(La durée de vie de l'outil est plus courte par rapport à la coupe à sec.)

Remarque 2) Nous recommandons la coupe lubrifiée avec arrosage interne pour les alliages de titane et réfractaires.

Remarque 3) Lorsque la raideur du collier est faible ou que les porte-à-faux sont importants, nous recommandons de réduire les vitesses de coupe et d'avance de 30 %.

■ Conditions de coupe avec plaquette de planage

	Matière	Dureté	Plaquette principale	Nuance	Plaquette wiper	Nuance	Vc (m/min)	fz (mm/dent)	ap (mm)	ae (mm)
P	Acier doux	≤180HB	VP15TF	MP	VP15TF	WP	250 (200–300)	0.3 (0.2–0.4)	≤0.5	≤0.8DC
			MP6120	M	MP6120	M	250 (200–300)	0.3 (0.2–0.4)	≤0.5	≤0.8DC
	Acier carbone, Alliage acier	180–280HB	VP15TF	MP	VP15TF	WP	220 (170–270)	0.3 (0.2–0.4)	≤0.5	≤0.8DC
			MP6120	M	MP6120	M	220 (170–270)	0.3 (0.2–0.4)	≤0.5	≤0.8DC
	Acier carbone, Alliage acier	280–350HB	VP15TF	MP	VP15TF	WP	140 (100–180)	0.3 (0.2–0.4)	≤0.5	≤0.8DC
			MP6120	M	MP6120	M	140 (100–180)	0.3 (0.2–0.4)	≤0.5	≤0.8DC
K	Fonte grise	Résistance à la traction ≤350MPa	MC5020	MK, HK	MC5020	WK	320 (250–400)	0.3 (0.2–0.4)	≤0.5	≤0.8DC
			VP15TF	MP	VP15TF	WP	220 (150–300)	0.3 (0.2–0.4)	≤0.5	≤0.8DC
	Fonte ductile	Résistance à la traction ≤450MPa	MC5020	MK, HK	MC5020	WK	250 (200–300)	0.2 (0.1–0.3)	≤0.5	≤0.8DC
			VP15TF	MP	VP15TF	WP	200 (150–250)	0.2 (0.1–0.3)	≤0.5	≤0.8DC
	Fonte ductile	Résistance à la traction ≤800MPa	MC5020	MK, HK	MC5020	WK	220 (200–250)	0.2 (0.1–0.3)	≤0.5	≤0.8DC
			VP15TF	MP	VP15TF	WP	170 (150–200)	0.2 (0.1–0.3)	≤0.5	≤0.8DC
S	Alliage réfractaire	–	VP15TF	MP	VP15TF	WP	40 (20–50)	0.15 (0.1–0.2)	≤0.5	≤0.8DC
H	Acier trempé	40–55HRC	VP15TF	MP	VP15TF	WP	80 (60–100)	0.15 (0.1–0.2)	≤0.5	≤0.8DC

Remarque 1) Pour l'usinage d'une pièce de faible raideur ou avec des porte-à-faux importants, nous recommandons de réduire les vitesses de coupe et d'avance de 30 %.

Remarque 2) Veuillez utiliser une plaquette de géométrie WP avec des plaquettes de coupe MP ou M, et une plaquette de géométrie WK en combinaison avec des plaquettes de coupe MK ou HK.

DIMENSIONS DE MONTAGE AHX440S, AHX475S, AHX640S

Fig. 1

ø40
ø50
ø63
ø80

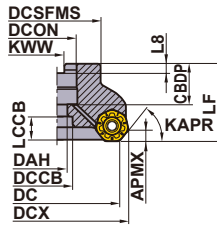

Fig. 2

ø100
ø125

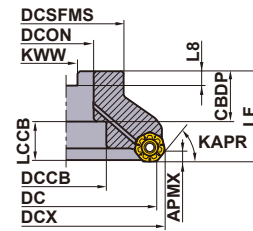
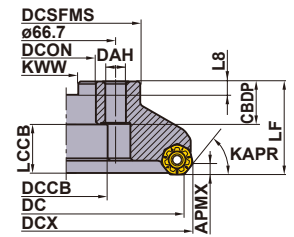

Fig. 3

ø160



Porte-outil à droite uniquement.

DCON (mm)	DC (mm)	Référence	Dimensions (mm)							Fig.
			CBDP	DAH	DCCB	LCCB	DCSFMS	KWW	L8	
16	40	AHX440S-040A03AR	18	9	14	13.9	37	8.4	5.6	1
16	40	AHX440S-040A04AR	18	9	14	13.9	37	8.4	5.6	1
22	50	AHX440S-050A04AR	20	11	17	11.9	47	10.4	6.3	1
22	50	AHX440S-050A05AR	20	11	17	11.9	47	10.4	6.3	1
22	50	AHX440S-050A06AR	20	11	17	11.9	47	10.4	6.3	1
22	50	AHX475S-050A04AR	20	11	17	16.7	47	10.4	6.3	5
22	50	AHX475S-050A05AR	20	11	17	16.7	47	10.4	6.3	5
22	63	AHX440S-063A05AR	20	11	17	11.9	50	10.4	6.3	1
22	63	AHX440S-063A06AR	20	11	17	11.9	50	10.4	6.3	1
22	63	AHX440S-063A08AR	20	11	17	11.9	50	10.4	6.3	1
22	63	AHX475S-063A05AR	20	11	17	16.7	60	10.4	6.3	5
22	63	AHX475S-063A06AR	20	11	17	16.7	60	10.4	6.3	5
22	63	AHX640S-063A04AR	20	11	17	16.2	50	10.4	6.3	1
22	63	AHX640S-063A05AR	20	11	17	16.2	50	10.4	6.3	1
27	80	AHX440S-080A06AR	23	13	20	14.9	56	12.4	7	1
27	80	AHX440S-080A08AR	23	13	20	14.9	56	12.4	7	1
27	80	AHX440S-080A10AR	23	13	20	14.9	56	12.4	7	1
27	80	AHX475S-080A06AR	23	13	20	14.7	76	12.4	7	5
27	80	AHX475S-080A08AR	23	13	20	14.7	76	12.4	7	5
27	80	AHX640S-080A04AR	23	13	20	15.2	56	12.4	7	1
27	80	AHX640S-080A06AR	23	13	20	15.2	56	12.4	7	1

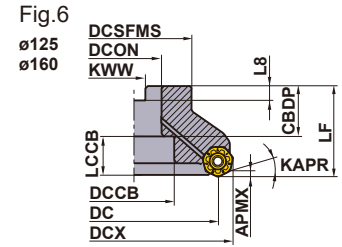
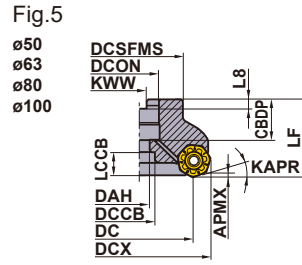
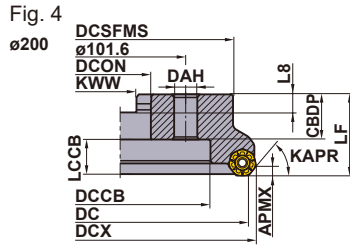

Porte-outil à droite uniquement.

DCON (mm)	DC (mm)	Référence	Dimensions (mm)							Fig.
			CBDP	DAH	DCCB	LCCB	DCSFMS	KWW	L8	
32	100	AHX440S-100B07AR	32	—	45	16.9	78	14.4	8	2
32	100	AHX440S-100B10AR	32	—	45	16.9	78	14.4	8	2
32	100	AHX440S-100B12AR	32	—	45	16.9	78	14.4	8	2
32	100	AHX475S-100A07AR	26	17	26	25.7	96	14.4	8	5
32	100	AHX475S-100A09AR	26	17	26	25.7	96	14.4	8	5
32	100	AHX640S-100B05AR	32	—	45	16.2	78	14.4	8	2
32	100	AHX640S-100B07AR	32	—	45	16.2	78	14.4	8	2
40	125	AHX440S-125B08AR	40	—	56	21.9	89	16.4	9	2
40	125	AHX440S-125B12AR	40	—	56	21.9	89	16.4	9	2
40	125	AHX440S-125B14AR	40	—	56	21.9	89	16.4	9	2
40	125	AHX475S-125B08AR	40	—	56	21.7	100	16.4	9	6
40	125	AHX475S-125B10AR	40	—	56	21.7	100	16.4	9	6
40	125	AHX640S-125B06AR	42	—	56	19.2	89	16.4	9	2
40	125	AHX640S-125B08AR	42	—	56	19.2	89	16.4	9	2
40	160	AHX440S-160C10NR	40	14	56	21.9	100	16.4	9	3
40	160	AHX440S-160C14NR	40	14	56	21.9	100	16.4	9	3
40	160	AHX440S-160C16NR	40	14	56	21.9	100	16.4	9	3
40	160	AHX475S-160B10AR	40	—	56	21.7	100	16.4	9	6
40	160	AHX475S-160B12AR	40	—	56	21.7	100	16.4	9	6
40	160	AHX640S-160C07NR	29	14	56	32.2	120	16.4	9	3
40	160	AHX640S-160C10NR	29	14	56	32.2	120	16.4	9	3
60	200	AHX640S-200C08NR	32	18	140	29.2	175	25.7	14.22	4
60	200	AHX640S-200C12NR	32	18	140	29.2	175	25.7	14.22	4

K

FRAISES À PLAQUETTES

FRAISES À PLAQUETTES

FRAISES À SURFACER

<FRAISAGE FORTE AVANCE FONTE>



AHX640W

P M **K** N S H



K

FRAISES À PLAQUETTES

Fig.1
ø80

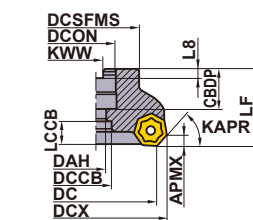

Fig.2
ø100
ø125

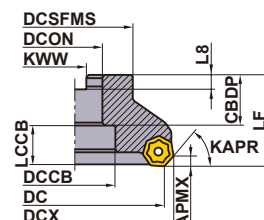

Fig.3
ø160

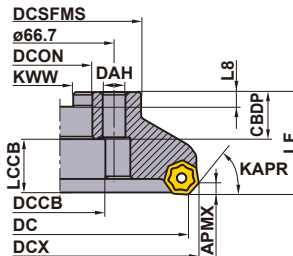

Fig.4
ø200
ø250

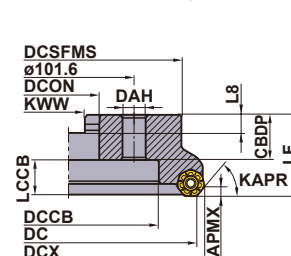
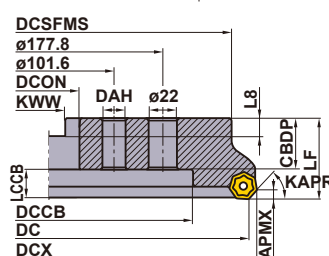

Fig.5
ø315



KAPR : 50°
GAMP: -6° GAMF: -4°

■ CORPS À DROITE

DC (mm)	Référence	Stock	Trou d'arrosage	Nombre de dents	Dimensions (mm)			Fig.	WT* (kg)	APMX (mm)
					LF	DCX	DCON			
80	AHX640W-080A08R	●	-	8	50	92.6	27	1	1.5	6
	AHX640W-080A10R	●	-	10	50	92.6	27	1	1.5	6
100	AHX640W-100B10R	●	-	10	50	112.6	32	2	2.1	6
	AHX640W-100B14R	●	-	14	50	112.6	32	2	2.1	6
125	AHX640W-125B12R	●	-	12	63	137.6	40	2	3.1	6
	AHX640W-125B18R	●	-	18	63	137.6	40	2	3.1	6
160	AHX640W-160C16R	●	-	16	63	172.6	40	3	5.6	6
	AHX640W-160C22R	●	-	22	63	172.6	40	3	5.6	6
200	AHX640W-200C20R	●	-	20	63	212.6	60	4	8	6
	AHX640W-200C28R	●	-	28	63	212.6	60	4	8	6
250	AHX640W-250C24R	●	-	24	63	262.6	60	4	12.6	6
	AHX640W-250C36R	●	-	36	63	262.6	60	4	12.6	6
315	AHX640W-315C28R	●	-	28	80	327.6	60	5	31.5	6
	AHX640W-315C44R	●	-	44	80	327.6	60	5	31.5	6

* WT : Poids de l'outil





■ CORPS À GAUCHE

DC (mm)	Référence	Stock	Trou d'arrosage	Nombre de dents	Dimensions (mm)			Fig.	WT (kg)	APMX (mm)
					LF	DCX	DCON			
80	AHX640W-080A08L	★	-	8	50	92.6	27	1	1.5	6
	AHX640W-080A10L	★	-	10	50	92.6	27	1	1.5	6
100	AHX640W-100B10L	★	-	10	50	112.6	32	2	2.1	6
	AHX640W-100B14L	★	-	14	50	112.6	32	2	2.1	6
125	AHX640W-125B12L	★	-	12	63	137.6	40	2	3.1	6
	AHX640W-125B18L	★	-	18	63	137.6	40	2	3.1	6
160	AHX640W-160C16L	★	-	16	63	172.6	40	3	5.6	6
	AHX640W-160C22L	★	-	22	63	172.6	40	3	5.6	6
200	AHX640W-200C20L	★	-	20	63	212.6	60	4	8.0	6
	AHX640W-200C28L	★	-	28	63	212.6	60	4	8.0	6
250	AHX640W-250C24L	★	-	24	63	262.6	60	4	12.6	6
	AHX640W-250C36L	★	-	36	63	262.6	60	4	12.6	6
315	AHX640W-315C28L	★	-	28	80	327.6	60	5	31.5	6
	AHX640W-315C44L	★	-	44	80	327.6	60	5	31.5	6

● : Article stocké. ★ : Article standard Japon.

(10 plaquettes par boîte)

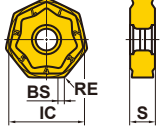

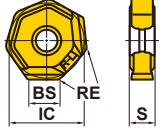
PLAQUETTES

Matière	K	Fonte	●	●	✦	Conditions de coupe (Guide) : ● : Coupe Stable ● : Coupe Générale ✦ : Coupe Instable Honing : E : Ronde					Géométrie	
						Revêtu	Dimensions (mm)					
Forme	Référence	Classe	Honing	MC5020	VP15TF	VP20RT	IC	RE	BS	S	APMX	
				 Coupe Générale	NNMU200608ZEN-MK	M	E	●	★	★	20	0.8
 Arête de coupe renforcée	NNMU200608ZEN-HK	M	E	●	★	★	20	0.8	1.0	6.55	6	
 Planage	WNEU2006ZEN7C-WK	E	E	●			20	0.8	7.4	6.55	0.5	

K
FRAISES À PLAQUETTES

PIÈCES DÉTACHÉES



Référence porte-outil		 *	
	Coin	Vis de serrage	Clé
AHX640W	CWAHX640WN	LS0622T	TKY15T

* Couple de serrage (N • m) : LS0622T=6,0

CONDITIONS DE COUPE RECOMMANDÉES

■ Coupe à sec-Coupe lubrifiée

Matière	Résistance traction	Nuance	Vc (m/min)	fz (mm/dent)
K Fonte grise	≤350MPa	MC5020	220 (150-300)	0.3 (0.2-0.4)
		VP15TF VP20RT	180 (130-250)	0.3 (0.2-0.4)
Fonte ductile	≤450MPa	MC5020	200 (150-250)	0.2 (0.1-0.3)
		VP15TF VP20RT	170 (120-220)	0.2 (0.1-0.3)
	≤800MPa	MC5020	170 (150-200)	0.2 (0.1-0.3)
		VP15TF VP20RT	140 (100-180)	0.2 (0.1-0.3)

■ Finition (Avec plaquettes Wiper)

Matière	Nuance	ap (mm)	Vc (m/min)	fz (mm/dent)
K Fonte grise	MC5020	<0.5	320 (250-400)	0.2 (0.1-0.3)
		0.5-3	270 (200-350)	
Fonte ductile	<0.5	270 (200-350)		
	0.5-3	220 (200-250)		

* Veuillez utiliser 2 ou 3 plaquettes de planage si plus de 6 mm/tr.

Remarque 1) En vous reportant aux exemples ci-dessus, ajustez les conditions de coupe selon l'environnement d'utilisation.

Remarque 2) La durée de vie de l'outil en coupe lubrifiée est plus courte par rapport à la coupe à sec.

DIMENSIONS DE MONTAGE > K050
PIÈCES DÉTACHÉES > N001
DONNÉES TECHNIQUES > P001

K049

DIMENSIONS DE MONTAGE AHX640W

Fig.1

ø80

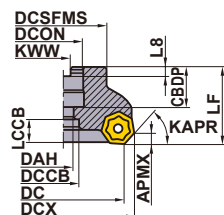

Fig.2

ø100
ø125

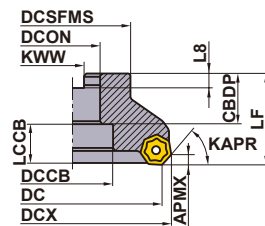

Fig.3

ø160

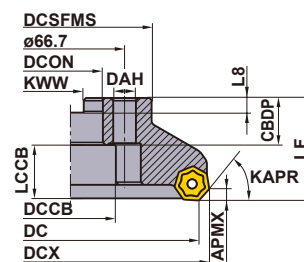

Fig.4

ø200
ø250

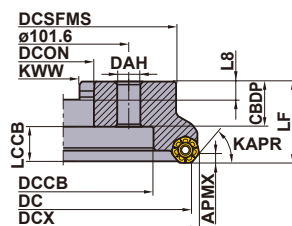
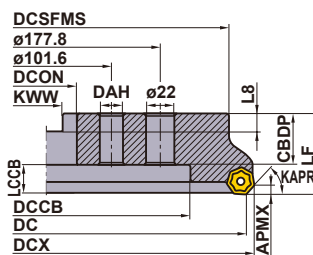

Fig.5

ø315



Plaquette représentée à droite.

DCON (mm)	DC (mm)	Référence	Dimensions (mm)							Fig.
			CBDB	DAH	DCCB	LCCB	DCSFMS	KWW	L8	
27	80	AHX640W-080A08L	23	13	20	14.8	56	12.4	7	1
27	80	AHX640W-080A08R	23	13	20	14.8	56	12.4	7	1
27	80	AHX640W-080A10L	23	13	20	14.8	56	12.4	7	1
27	80	AHX640W-080A10R	23	13	20	14.8	56	12.4	7	1
32	100	AHX640W-100B10L	32	—	45	16.8	70	14.4	8	2
32	100	AHX640W-100B10R	32	—	45	16.8	70	14.4	8	2
32	100	AHX640W-100B14L	32	—	45	16.8	70	14.4	8	2
32	100	AHX640W-100B14R	32	—	45	16.8	70	14.4	8	2
40	125	AHX640W-125B12L	32	—	56	29.8	80	16.4	9	2
40	125	AHX640W-125B12R	32	—	56	29.8	80	16.4	9	2
40	125	AHX640W-125B18L	32	—	56	29.8	80	16.4	9	2
40	125	AHX640W-125B18R	32	—	56	29.8	80	16.4	9	2
40	160	AHX640W-160C16L	29	14	56	32.8	100	16.4	9	3
40	160	AHX640W-160C16R	29	14	56	32.8	100	16.4	9	3
40	160	AHX640W-160C22L	29	14	56	32.8	100	16.4	9	3
40	160	AHX640W-160C22R	29	14	56	32.8	100	16.4	9	3
60	200	AHX640W-200C20L	32	18	135	29.8	155	25.7	14.22	4
60	200	AHX640W-200C20R	32	18	135	29.8	155	25.7	14.22	4
60	200	AHX640W-200C28L	32	18	135	29.8	155	25.7	14.22	4
60	200	AHX640W-200C28R	32	18	135	29.8	155	25.7	14.22	4
60	250	AHX640W-250C24L	32	18	180	29.8	200	25.7	14.22	4
60	250	AHX640W-250C24R	32	18	180	29.8	200	25.7	14.22	4
60	250	AHX640W-250C36L	32	18	180	29.8	200	25.7	14.22	4
60	250	AHX640W-250C36R	32	18	180	29.8	200	25.7	14.22	4
60	315	AHX640W-315C28L	57	18	225	21.8	285	25.7	14.22	5
60	315	AHX640W-315C28R	57	18	225	21.8	285	25.7	14.22	5
60	315	AHX640W-315C44L	57	18	225	21.8	285	25.7	14.22	5
60	315	AHX640W-315C44R	57	18	225	21.8	285	25.7	14.22	5

FRAISES À SURFACER

<FINITION À GRANDE AVANCE>

90°
KAPR



FMAX

P M **K** N S H

Corps allégés



Fig.1
ø100
ø125

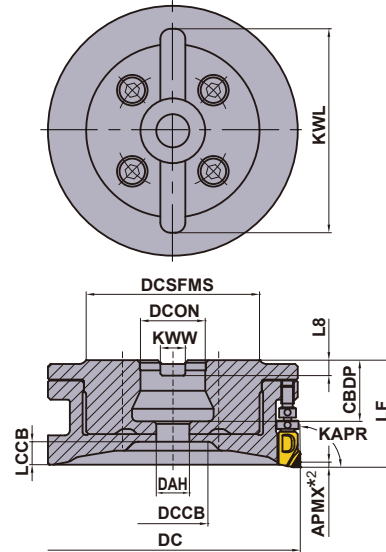

Porte-outil à droite uniquement.

ATTACHEMENT PAR ALÉSAGE

KAPR: 90°

GAMP : nuance PCD +5°, nuance CBN 0° GAMP : 0°

DC (mm)	Référence	Stock	Trou d'arrosage	Nombre de dents	Dimensions (mm)		WT*1 (kg)	RPMX (min-1)	Fig.
					LF	DCON			
100	NEW FMAXR10010CLW	★	○	10	42	25.4	1.06	22000	1
100	NEW FMAXR10016CLW	★	○	16	42	25.4	1.11	22000	1
125	NEW FMAXR12514CLW	★	○	14	42	25.4	1.44	19600	1
125	NEW FMAXR12520CLW	★	○	20	42	25.4	1.48	19600	1

*1 WT : poids du corps

*2 Pour la profondeur maximale de coupe (APMX), veuillez vous reporter aux conditions de coupe recommandées (ap).

Remarque 1) La profondeur de passe doit être inférieure ou égale à 2mm pour obtenir une productivité maximale (Vf ≥ 20000 mm/min).

Remarque 2) L'angle de coupe axial GAMP varie en fonction de la nuance des plaquettes.

DIMENSIONS DE MONTAGE

DCON (mm)	DC (mm)	Référence	Dimensions (mm)								Fig.
			CBDB	DAH	DCCB	LCCB	DCSFMS	KWW	L8	KWL	
25.4	100	FMAXR10010CLW	24	13	27	9	68	9.5	6	80	1
25.4	100	FMAXR10016CLW	24	13	27	9	68	9.5	6	80	1
25.4	125	FMAXR12514CLW	24	13	52	9	68	9.5	6	80	1
25.4	125	FMAXR12520CLW	24	13	52	9	68	9.5	6	80	1

PIÈCES DÉTACHÉES

Vis de serrage plaquette *	Écrou d'ajustement micrométrique	Vis d'ajustement général	Vis d'attachement	Clé T10	Clé ø2.5
TSS04505S	KSN3	KSS2	HSCX12030H	TKY10T	RKY25S

* Couple de serrage TS04505S : 3,5 Nm

Remarque 1) Veuillez vous reporter aux instructions du manuel fourni avec le corps la fraise pour le réglage des plaquettes et l'équilibrage.

★ : Article standard Japon.

PIÈCES DÉTACHÉES > N001
DONNÉES TECHNIQUES > P001

K051

K

FRAISES À PLAQUETTES

FMAX - 40/50/63

K
FRAISES À PLAQUETTES



Fig.1
ø40
ø50
ø63

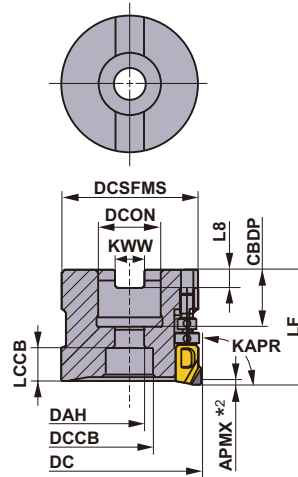

ATTACHEMENT PAR ALÉSAGE

KAPR: 90°

GAMP : nuance PCD +5°, nuance CBN 0° GAMPF : -6°—-3°

Porte-outil à droite uniquement.

DC (mm)	Référence	Stock	Trou d'arrosage	Nombre de dents	Dimensions (mm)		WT*1 (kg)	RPMX (min-1)	Fig.
					LF	DCON			
40	FMAX-040A04R	★	○	4	40	16	0.24	30000	1
40	FMAX-040A06R	★	○	6	40	16	0.23	30000	1
50	FMAX-050A08R	★	○	8	40	22	0.37	30000	1
50	FMAX-050A10R	●	○	10	40	22	0.35	30000	1
63	FMAX-063A10R	★	○	10	40	22	0.67	27000	1
63	FMAX-063A12R	●	○	12	40	22	0.66	27000	1

*1 WT : poids du corps

*2 Pour la profondeur maximale de coupe (APMX), veuillez vous reporter aux conditions de coupe recommandées (ap).

Remarque 1) La profondeur de passe doit être inférieure ou égale à 2mm pour obtenir une productivité maximale (Vf ≥ 20000 mm/min).

Remarque 2) L'angle de coupe axial GAMPF varie en fonction de la nuance des plaquettes.

DIMENSIONS DE MONTAGE

DCON (mm)	DC (mm)	Référence	Dimensions (mm)								Fig.
			CBDP	DAH	DCCB	LCCB	DCSFMS	KWW	L8	KWL	
16	40	FMAX-040A04R	18	9	14	10	37	8.4	5.6	—	1
16	40	FMAX-040A06R	18	9	14	10	37	8.4	5.6	—	1
22	50	FMAX-050A08R	20	11	17	12	47	10.4	6.3	—	1
22	50	FMAX-050A10R	20	11	17	12	47	10.4	6.3	—	1
22	63	FMAX-063A10R	20	11	17	12	60	10.4	6.3	—	1
22	63	FMAX-063A12R	20	11	17	12	60	10.4	6.3	—	1

PIÈCES DÉTACHÉES

DC	Porte-outil Type	Vis de serrage* plaquette	Écrou d'ajustement micrométrique	Vis d'ajustement général	Vis d'attachement	Clé T10	Clé ø2.5
40	FMAX-040	TSS04505S	KSN3	KSS2	HSC08030H	TKY10T	RKY25S
50	FMAX-050	TSS04505S	KSN3	KSS2	HSC10030H	TKY10T	RKY25S
63	FMAX-063	TSS04505S	KSN3	KSS2	HSC10030H	TKY10T	RKY25S

* Couple de serrage TS04505S : 3,5 Nm

Remarque 1) Veuillez vous reporter aux instructions du manuel fourni avec le corps la fraise pour le réglage des plaquettes et l'équilibrage.

● : Article stocké. ★ : Article standard Japon.

FMAX



Fig.1
ø80

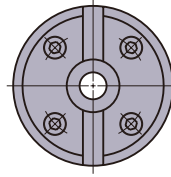
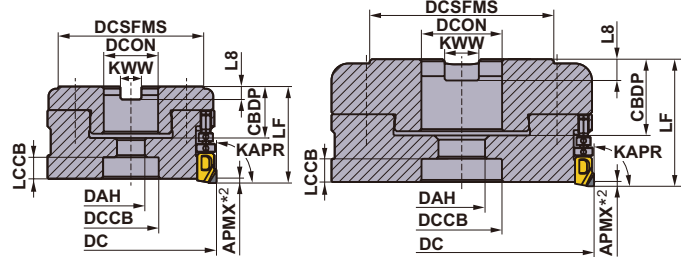
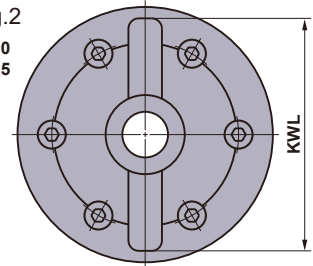

Fig.2
ø100
ø125



Porte-outil à droite uniquement.

ATTACHEMENT PAR ALÉSAGE

KAPR: 90°

GAMP : nuance PCD +5°, nuance CBN 0° GAMF : 0°

DC (mm)	Référence	Stock	Trou d'arrosage	Nombre de dents	Dimensions (mm)		WT ^{*1} (kg)	RPMX (min-1)	Fig.
					LF	DCON			
80	FMAX-080B14R	●	○	14	45	27	1.08	24500	1
100	FMAX-100B18R	●	○	18	50	32	1.81	22000	2
125	FMAX-125B24R	●	○	24	60	40	3.26	19600	2

*1 WT : poids du corps

*2 Pour la profondeur maximale de coupe (**APMX**), veuillez vous reporter aux conditions de coupe recommandées (**ap**).

Remarque 1) La profondeur de passe doit être inférieure ou égale à 2mm pour obtenir une productivité maximale (**Vf** ≥ 20000 mm/min).

Remarque 2) L'angle de coupe axial **GAMP** varie en fonction de la nuance des plaquettes.

DIMENSIONS DE MONTAGE

DCON (mm)	DC (mm)	Référence	Dimensions (mm)								Fig.
			CBDB	DAH	DCCB	LCCB	DCSFMS	KWW	L8	KWL	
27	80	FMAX-080B14R	24	13	26	11	68	12.4	7	—	1
32	100	FMAX-100B18R	32	17	32	10	79	14.4	8	90	2
40	125	FMAX-125B24R	36	22	38	12	88	16.4	9	112	2

PIÈCES DÉTACHÉES

DC	Porte-outil Type	Vis de serrage plaquette*	Écrou d'ajustement micrométrique	Vis d'ajustement général	Vis d'attachement	Clé T10	Clé ø2.5
80	FMAX-080	TSS04505S	KSN3	KSS2	HSCX12030H	TKY10T	RKY25S
100	FMAX-100	TSS04505S	KSN3	KSS2	HSCX16035H	TKY10T	RKY25S
125	FMAX-125	TSS04505S	KSN3	KSS2	HSCX20035H	TKY10T	RKY25S

* Couple de serrage TS04505S : 3,5 Nm

Remarque 1) Veuillez vous reporter aux instructions du manuel fourni avec le corps la fraise pour le réglage des plaquettes et l'équilibrage.

FRAISES À PLAQUETTES

PLAQUETTES

Matière	K	Fonte	●	●	●	Conditions de coupe :					Géométrie
	N	Non ferreux				●	●	✚	●	●	
Forme	Référence	MD220	MD2030	MB4120	Dimensions (mm)					Géométrie	
					L	LE	W1	S	BS		RE
Pour les alliages d'aluminium	GOER1404PXFR2	●	●		14.0	5.0	9.0	4.2	2.0	0.4	
	GOER1408PXFR2	●	●		14.0	5.0	9.0	4.2	2.0	0.8	
Application générale											
Pour les fontes grises	NEW NP-GOEN1404PXSR05			★	14.0	2.5	9.0	4.2	0.5	0.4	
	NEW NP-GOEN1408PXSR05			★	14.0	2.5	9.0	4.2	0.5	0.8	
Application générale											
Pour les alliages d'aluminium	NEW GOER1408PXFR2-8	★			14.0	8.0	9.0	4.2	2.0	0.8	
Arête longue											
Pour les alliages d'aluminium	GOER1401ZXFR2	●			14.0	5.0	9.0	4.2	2.0	0.1	
Anti-bavures											

Plaquettes PCD : Arête vive

Plaquettes CBN : Chanfrein et arrondi (0,13 mm x 15°+ R0,01)

● = NEW

Remarque 1) Il n'est pas possible de monter en même temps différentes références de plaquettes sur le même corps. Il faut utiliser des plaquettes de la même géométrie sur la monte entière.

Remarque 2) Le diamètre de coupe DC varie en fonction de la géométrie de plaquette.

Attention aux interférences avec le corps d'outil lors de l'usinage à proximité de parois verticales.

Remarque 3) Les plaquettes à arête longue ne sont pas prévues pour un usinage continu à profondeur de passe maximale.

● : Article stocké. ★ : Article standard Japon.

(Les plaquettes CBN et PCD sont conditionnées par 1 pièce par boîte)

CONDITIONS DE COUPE RECOMMANDÉES

	Matière	Propriétés	Nuance	Vc (m/min)	ae (mm)	ap (mm)	fz (mm/dent)	Lubrification
K	Fonte grise	Résistance à la traction ≤350MPa	MB4120	1000 (700–1300)	≤ 0.8 DC	≤ 0.5	0.07 (0.05–0.15)	Usinage à sec
N	Alliage aluminium	Teneur en silicium Si < 5%	MD2030 MD220	2500 (2000–3000)	≤ 0.2 DC	≤ 3.0 (0.5–3.0)	0.08 (0.05–0.2)	Coupe lubrifiée
					≤ 0.5 DC	≤ 2.5 (0.5–2.5)		
					≤ 0.8 DC	≤ 2.0 (0.5–2.0)		
		Teneur en silicium 5% ≤ Si ≤ 10%	MD2030 MD220	2500 (2000–3000)	≤ 0.2 DC	≤ 3.0 (0.5–3.0)	0.08 (0.05–0.2)	Coupe lubrifiée
					≤ 0.5 DC	≤ 2.5 (0.5–2.5)		
					≤ 0.8 DC	≤ 2.0 (0.5–2.0)		
		Teneur en silicium 10% < Si < 15%	MD220 MD2030	600 (400–800)	≤ 0.2 DC	≤ 3.0 (0.5–3.0)	0.08 (0.05–0.2)	Coupe lubrifiée
					≤ 0.5 DC	≤ 2.5 (0.5–2.5)		
					≤ 0.8 DC	≤ 2.0 (0.5–2.0)		
		Teneur en silicium Si ≥ 15%	MD220 MD2030	600 (400–800)	≤ 0.2 DC	≤ 3.0 (0.5–3.0)	0.08 (0.05–0.2)	Coupe lubrifiée
					≤ 0.5 DC	≤ 2.5 (0.5–2.5)		
					≤ 0.8 DC	≤ 2.0 (0.5–2.0)		

Remarque 1) Veuillez ajuster la profondeur de passe en fonction de l'engagement radial.

Remarque 2) Lors de l'utilisation de la plaquette à arête longue, veuillez sélectionner les conditions en fonction des profondeurs de coupe (ap) sans tenir compte des surépaisseurs au niveau de l'attaque de coulée.

K

FRAISES À PLAQUETTES

FRAISES À PLAQUETTES

FRAISES À SURFACER-DRESSER <FRAISAGE EN GÉNÉRAL>



WWX400

NEW

P M K N S H

K

FRAISES À PLAQUETTES



Fig.1
ø50

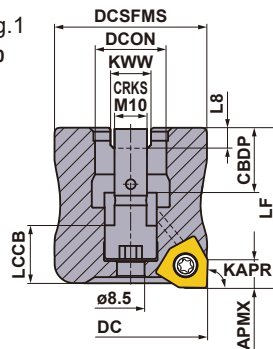
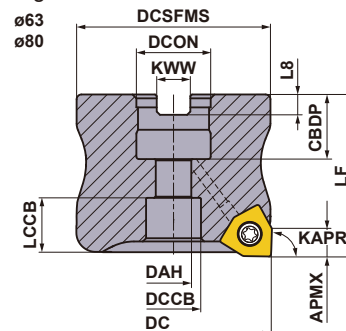

Fig.2



Porte-outil à droite uniquement.

ATTACHEMENT PAR ALÉSAGE

KAPR : 90°

GAMP : -6° GAMF : -7.2° - -12.8°

DC (mm)	Référence	Stock	Trou d'arrosage	Nombre de dents	Dimensions (mm)		APMX (mm)	WT* (kg)	RMPX	RPMX (min ⁻¹)	Fig.
					LF	DCON					
50	WWX400-050A03AR	★	○	3	55	22	8.2	0.5	0.4°	5000	1
50	WWX400-050A04AR	●	○	4	55	22	8.2	0.5	0.4°	5000	1
63	WWX400-063A03AR	★	○	3	40	22	8.2	0.5	0.26°	14100	2
63	WWX400-063A04AR	●	○	4	40	22	8.2	0.5	0.26°	14100	2
63	WWX400-063A05AR	●	○	5	40	22	8.2	0.5	0.26°	14100	2
80	WWX400-080A04AR	★	○	4	50	27	8.2	1.0	0.16°	12200	2
80	WWX400-080A05AR	●	○	5	50	27	8.2	1.0	0.16°	12200	2
80	WWX400-080A07AR	●	○	7	50	27	8.2	0.9	0.16°	12200	2
100	WWX400-100B05AR	★	○	5	50	32	8.2	1.6	—	10700	3
100	WWX400-100B07AR	●	○	7	50	32	8.2	1.5	—	10700	3
100	WWX400-100B09AR	●	○	9	50	32	8.2	1.5	—	10700	3
125	WWX400-125B06AR	★	○	6	63	40	8.2	3.0	—	9500	3
125	WWX400-125B08AR	●	○	8	63	40	8.2	3.0	—	9500	3
125	WWX400-125B12AR	★	○	12	63	40	8.2	2.9	—	9500	3
160	WWX400-160C08NR	★	—	8	63	40	8.2	4.5	—	8300	4
160	WWX400-160C10NR	★	—	10	63	40	8.2	4.4	—	8300	4
160	WWX400-160C14NR	★	—	14	63	40	8.2	4.4	—	8300	4
200	WWX400-200C10NR	★	—	10	63	60	8.2	6.7	—	7300	5
200	WWX400-200C12NR	★	—	12	63	60	8.2	6.7	—	7300	5
200	WWX400-200C16NR	★	—	16	63	60	8.2	6.6	—	7300	5
250	WWX400-250C12NR	★	—	12	63	60	8.2	11.5	—	6400	5
250	WWX400-250C14NR	★	—	14	63	60	8.2	11.5	—	6400	5
250	WWX400-250C18NR	★	—	18	63	60	8.2	11.4	—	6400	5

Remarque 1) Le corps est fourni sans vis d'attache. Cf. page K057 lors de la commande.

Remarque 2) Les corps de diamètre de coupe DC = 50 mm disposent d'une vis d'attache intégrée. Celle-ci ne peut pas être remplacée.

Veuillez ne pas démonter le corps de fraise.

Remarque 3) Veuillez utiliser une vis d'attache de type FMC pour les corps de fraise d'un diamètre DC de 63 à 100.

Remarque 4) Veuillez utiliser des vis d'attache de type FMA pour les corps de fraise d'un diamètre DC de 125 à 250.

* WT : Poids du corps

PIÈCES DÉTACHÉES

Porte-outil Type	*		
	Vis de fixation	Clé (Plaquette)	Anti-grippant
WWX400	TS5R	TKY20T	MK1KS

* Couple de serrage TS5R : 5,0 Nm

● : Article stocké. ★ : Article standard Japon.

Fig.3
ø100
ø125

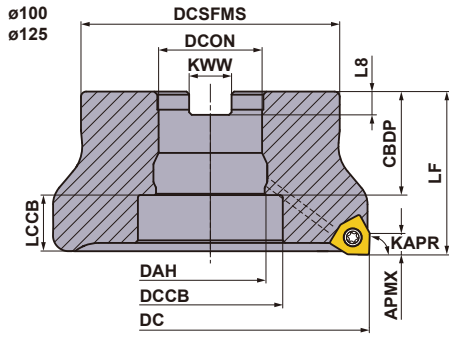
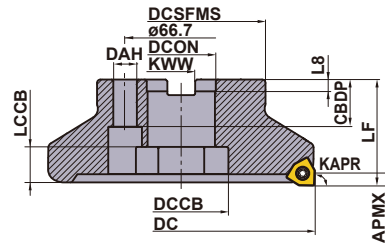
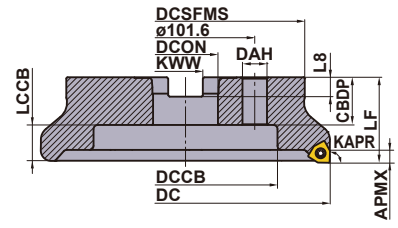

Fig.4
ø160



Corps à droite uniquement.

Fig.5
ø200
ø250



DIMENSIONS DE MONTAGE

DC (mm)	Référence	Dimensions (mm)								Fig.
		DCON	CBDP	DAH	DCCB	LCCB	DCSFMS	KWW	L8	
50	WWX400-050A03AR	22	20	—	—	12.2	47	10.4	6.3	1
50	WWX400-050A04AR	22	20	—	—	12.2	47	10.4	6.3	1
63	WWX400-063A03AR	22	20	11	17	11.2	50	10.4	6.3	2
63	WWX400-063A04AR	22	20	11	17	11.2	50	10.4	6.3	2
63	WWX400-063A05AR	22	20	11	17	11.2	50	10.4	6.3	2
80	WWX400-080A04AR	27	23	13	20	14.2	56	12.4	7	2
80	WWX400-080A05AR	27	23	13	20	14.2	56	12.4	7	2
80	WWX400-080A07AR	27	23	13	20	14.2	56	12.4	7	2
100	WWX400-100B05AR	32	32	32	45	16.2	78	14.4	8	3
100	WWX400-100B07AR	32	32	32	45	16.2	78	14.4	8	3
100	WWX400-100B09AR	32	32	32	45	16.2	78	14.4	8	3
125	WWX400-125B06AR	40	40	40	56	21.2	89	16.4	9	3
125	WWX400-125B08AR	40	40	40	56	21.2	89	16.4	9	3
125	WWX400-125B12AR	40	40	40	56	21.2	89	16.4	9	3
160	WWX400-160C08NR	40	40	14	56	21.2	100	16.4	9	4
160	WWX400-160C10NR	40	40	14	56	21.2	100	16.4	9	4
160	WWX400-160C14NR	40	40	14	56	21.2	100	16.4	9	4
200	WWX400-200C10NR	60	32	18	135	29.2	160	25.7	14.22	5
200	WWX400-200C12NR	60	32	18	135	29.2	160	25.7	14.22	5
200	WWX400-200C16NR	60	32	18	135	29.2	160	25.7	14.22	5
250	WWX400-250C12NR	60	32	18	180	29.2	210	25.7	14.22	5
250	WWX400-250C14NR	60	32	18	180	29.2	210	25.7	14.22	5
250	WWX400-250C18NR	60	32	18	180	29.2	210	25.7	14.22	5

VIS D'ATTACHEMENT (VENDUE SÉPARÉMENT)

Porte-outil Type	Vis d'attachement		Fig.	Dimensions (mm)								Géométrie
	Avec trou d'arrosage	Sans trou d'arrosage		a	b	c	d	e	f	g		
	Référence	Référence										
WWX400-063A \odot AR	HSC10030H	HSC10035	1	16	M10×1.5	40	10	6	—	—	Fig.1 	
WWX400-080A \odot AR	HSC12035H	HSC12035 HSC12045	1	18	M12×1.75	47 57	12	10	—	—		
WWX400-100B \odot AR	MBA16033H	—	2	40	M16×2	43	10	14	6	23	Fig.2 	
WWX400-125B \odot AR	MBA20040H	—	2	50	M20×2.5	54	14	17	6	27		
WWX400-160C \odot NR	Sans trous d'arrosage	—	2	50	M20×2.5	54	14	17	6	27		
WWX400-200C \odot NR	Sans trous d'arrosage	—	1	24	M16×2	43	16	14	—	—		
WWX400-250C \odot NR	Sans trous d'arrosage	—	1	24	M16×2	43	16	14	—	—		

Remarque 1) L'arrosage interne nécessite des vis d'attachement spécifiques.

Remarque 2) La fraise avec un diamètre de coupe DC = 50 mm dispose d'une vis d'attachement intégrée. Utiliser une clé à 6 pans de 7 mm pour serrer/desserrer la vis d'attachement.

FRAISES À PLAQUETTES

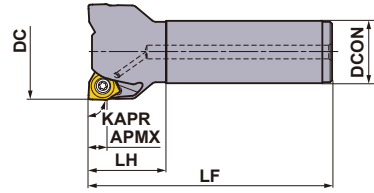

Porte-outil à droite uniquement.

K

FRAISES À PLAQUETTES



■ ATTACHEMENT CYLINDRIQUE

Avec trou de lubrification

DC (mm)	Référence	Stock	Nombre de dents	Dimensions (mm)			APMX (mm)	WT [*] (kg)	RMPX	RPMX (min ⁻¹)
		R		LF	DCON	LH				
50	WWX400R5003SA32M	★	3	125	32	40	8.2	0.8	0.4°	16000
50	WWX400R5004SA32M	★	4	125	32	40	8.2	0.8	0.4°	16000
63	WWX400R6303SA32M	★	3	125	32	40	8.2	1.0	0.26°	14100
63	WWX400R6304SA32M	★	4	125	32	40	8.2	1.0	0.26°	14100
63	WWX400R6305SA32M	★	5	125	32	40	8.2	1.0	0.26°	14100
80	WWX400R8004SA32M	★	4	125	32	40	8.2	1.3	0.16°	12200
80	WWX400R8005SA32M	★	5	125	32	40	8.2	1.3	0.16°	12200
80	WWX400R8007SA32M	★	7	125	32	40	8.2	1.2	0.16°	12200

* WT : Poids de l'outil

PIÈCES DÉTACHÉES

Porte-outil Type	*	*	*
			
	Vis de fixation	Clé (Plaquette)	Anti-grippant
WWX400	TS5R	TKY20T	MK1KS

* Couple de serrage TS5R : 5,0 Nm

● : Article stocké. ★ : Article standard Japon.
(10 plaquettes par boîte)

FRAISES À PLAQUETTES

CONDITIONS DE COUPE RECOMMANDÉES

■ Usinage à sec
Vitesse de coupe

(mm)

K

FRAISES À PLAQUETTES

Matière	Propriétés	Conditions de stabilité	Nuance	ae		
				0.5DC≥	0.8DC≥	DC(rainure)
				Vc (m/min)		
P	Acier doux Dureté ≤180HB	●	MP6120	240(200–280)	220(180–260)	200(160–240)
		●	MP6130	230(190–270)	210(170–250)	190(150–230)
		✱	MP6130,VP15TF	210(170–250)	190(150–230)	170(130–210)
	Acier carbone Alliage acier Dureté 180–280HB	●	MP6120	210(170–250)	190(150–230)	170(130–210)
		●	MP6130	200(160–240)	180(140–220)	160(120–200)
		✱	MP6130,VP15TF	180(140–220)	160(120–200)	140(100–180)
	Acier carbone Alliage acier Acier outil Dureté 280–350HB ≤350HB (recuit)	●	MP6120	200(160–240)	180(140–220)	160(120–200)
		●	MP6130	190(150–230)	170(130–210)	150(110–190)
		✱	MP6130,VP15TF	170(130–210)	150(110–190)	130(90–170)
	Acier pré-traité Dureté 35–45HRC	●	MP6120	140(120–160)	–	–
		●	MP6130	120(100–140)	–	–
		✱	MP6130,VP15TF	110(90–130)	–	–
M	Acier inoxydable austénitique Dureté ≤200HB	●	MP7130	180(160–200)	160(140–180)	–
		●	MP7130,VP15TF	170(150–190)	150(130–170)	–
		✱	MP7130,VP15TF	150(130–170)	130(110–150)	–
	Acier inoxydable austénitique Dureté >200HB	●	MP7130	170(150–190)	150(130–170)	–
		●	MP7130,VP15TF	160(140–180)	140(120–160)	–
		✱	MP7130,VP15TF	140(120–160)	120(100–140)	–
	Aciers inoxydables ferritiques et martensitiques Dureté ≤200HB	●	MP7130	180(160–200)	160(140–180)	–
		●	MP7130,VP15TF	170(150–190)	150(130–170)	–
		✱	MP7130,VP15TF	150(130–170)	130(110–150)	–
	Acier inoxydable duplex Dureté ≤280HB	●	MP7130	160(140–180)	140(120–160)	–
		●	MP7130,VP15TF	150(130–170)	130(110–150)	–
		✱	MP7130,VP15TF	130(110–150)	110(90–130)	–
Acier inoxydable à durcissement structural Dureté <450HB	●	MP7130	140(120–160)	–	–	
	●	MP7130,VP15TF	130(110–150)	–	–	
	✱	MP7130,VP15TF	110(90–130)	–	–	
K	Fonte grise Résistance à la traction ≤350MPa	●	MC5020	250(210–290)	230(190–270)	210(170–250)
		●	MC5020	240(200–280)	220(180–260)	200(160–240)
		●	VP15TF	240(200–280)	220(180–260)	–
		✱	MC5020,VP15TF	220(180–260)	200(160–240)	180(140–220)
	Fonte ductile Résistance à la traction ≤450MPa	●	MC5020	220(180–160)	200(160–240)	180(140–220)
		●	MC5020	210(170–250)	190(150–230)	170(130–210)
		●	VP15TF	210(170–250)	190(150–230)	–
	Fonte ductile Résistance à la traction ≤800MPa	✱	MC5020,VP15TF	190(150–230)	170(130–210)	150(110–190)
		●	MC5020	180(140–220)	160(120–200)	140(100–180)
		●	MC5020	170(130–210)	150(110–190)	130(90–170)
		●	VP15TF	170(130–210)	150(110–190)	–
	H	Acier trempé Dureté 40–55HRC	●	VP15TF	50(30–70)	–
●			VP15TF	50(30–70)	–	–
●			VP15TF	50(30–70)	–	–

Remarque 1) La vitesse de coupe est indiquée pour une profondeur de passe de 2 mm. Veuillez réduire la vitesse de coupe lors de profondeurs de passe plus importantes.

Conditions de coupe (Guide) :

● : Coupe Stable ● : Coupe Générale ✚ : Coupe Instable

■ Coupe lubrifiée
Vitesse de coupe

(mm)

Matière	Propriétés	Conditions de stabilité	Nuance	ae			
				0.5DC≥	0.8DC≥	DC(rainure)	
				Vc (m/min)			
P	Acier doux Dureté ≤180HB	●	MP6120	150(140–160)	130(120–140)	120(110–130)	
		●	MP6130	140(130–150)	120(110–130)	110(100–120)	
		✚	MP6130,VP15TF	120(110–130)	100(90–110)	90(80–100)	
	Acier carbone Alliage acier Dureté 180–280HB	●	MP6120	150(140–160)	130(120–140)	120(110–130)	
		●	MP6130	140(130–150)	120(110–130)	110(100–120)	
		✚	MP6130,VP15TF	120(110–130)	100(90–110)	90(80–100)	
	Acier carbone Alliage acier Acier outil Dureté 280–350HB ≤350HB (recuit)	●	MP6120	140(130–150)	120(110–130)	110(100–120)	
		●	MP6130	130(120–140)	110(100–120)	100(90–110)	
		✚	MP6130,VP15TF	110(100–120)	90(80–100)	80(70–90)	
	Acier pré-traité Dureté 35–45HRC	●	MP6120	110(100–120)	–	–	
		●	MP6130	100(90–110)	–	–	
		✚	MP6130,VP15TF	80(70–90)	–	–	
M	Acier inoxydable austénitique Dureté ≤200HB	●	MP7130	130(120–140)	110(100–120)	–	
		●	MP7130,VP15TF	120(110–130)	100(90–110)	–	
		✚	MP7130,VP15TF	100(90–110)	80(70–90)	–	
	Acier inoxydable austénitique Dureté >200HB	●	MP7130	130(120–140)	110(100–120)	–	
		●	MP7130,VP15TF	120(110–130)	100(90–110)	–	
		✚	MP7130,VP15TF	100(90–110)	80(70–90)	–	
	Aciers inoxydables ferritiques et martensitiques Dureté ≤200HB	●	MP7130	130(120–140)	110(100–120)	–	
		●	MP7130,VP15TF	120(110–130)	100(90–110)	–	
		✚	MP7130,VP15TF	100(90–110)	80(70–90)	–	
	Acier inoxydable duplex Dureté ≤280HB	●	MP7130	120(110–130)	100(90–110)	–	
		●	MP7130,VP15TF	110(100–120)	90(80–100)	–	
		✚	MP7130,VP15TF	90(80–100)	70(60–80)	–	
	Acier inoxydable à durcissement structural Dureté <450HB	●	MP7130	120(110–130)	–	–	
		●	MP7130,VP15TF	110(100–120)	–	–	
		✚	MP7130,VP15TF	90(80–100)	–	–	
	K	Fonte grise Résistance à la traction ≤350MPa	●	MC5020	170(150–190)	150(130–170)	130(110–150)
			●	MC5020	160(140–180)	140(120–160)	120(100–140)
			●	VP15TF	160(140–180)	140(120–160)	–
✚			MC5020,VP15TF	140(120–160)	120(100–140)	100(80–120)	
Fonte ductile Résistance à la traction ≤450MPa		●	MC5020	170(150–190)	150(130–170)	130(110–150)	
		●	MC5020	160(140–180)	140(120–160)	120(100–140)	
		●	VP15TF	160(140–180)	140(120–160)	–	
		✚	MC5020,VP15TF	140(120–160)	120(100–140)	100(80–120)	
Fonte ductile Résistance à la traction ≤800MPa		●	MC5020	160(150–170)	140(130–150)	120(110–130)	
		●	MC5020	150(140–160)	130(120–140)	110(100–120)	
		●	VP15TF	150(140–160)	130(120–140)	–	
		✚	MC5020,VP15TF	130(120–140)	110(100–120)	90(80–100)	
N	Alliage aluminium Teneur en silicium Si <5%	●	TF15	500(300–900)	500(300–900)	500(300–900)	
		●	TF15	500(300–900)	500(300–900)	500(300–900)	
		✚	TF15	400(200–800)	400(200–800)	400(200–800)	
S	Alliage titane –	●	MP9120	80(60–100)	–	–	
		●	MP9120	70(50–90)	–	–	
		✚	MP9130	60(40–80)	–	–	
	Alliage réfractaire –	●	MP9120	60(50–70)	–	–	
		●	MP9120	50(30–60)	–	–	
		✚	MP9130	40(20–40)	–	–	
H	Acier trempé Dureté 40–55HRC	●	VP15TF	50(30–70)	–	–	
		●	VP15TF	50(30–70)	–	–	

Remarque 1) Veuillez vous reporter au tableau ci-dessus pour les conditions de coupe.

K

FRAISES À PLAQUETTES

FRAISES À PLAQUETTES

CONDITIONS DE COUPE RECOMMANDÉES

Profondeur de Passe / Avance par Dent

Matière	Propriétés	Conditions de stabilité	Nuance	ae		
				0.5DC ≥		
				Brise-copeaux	ap	fz (mm/dent)
P	Acier doux Dureté ≤180HB	●	MP6120	L,M	≤4.0	0.13(0.10–0.15)
		●●	MP6130	L,M	≤4.0	0.13(0.10–0.15)
		●●		M,R	≤4.0	0.16(0.10–0.20)
		●●✚	MP6130,VP15TF	M,R	≤4.0	0.13(0.10–0.15)
	Acier carbone Alliage acier Dureté 180–280HB	●	MP6120	L,M	≤4.0	0.13(0.10–0.15)
		●●	MP6130	L,M	≤4.0	0.13(0.10–0.15)
		●●		M,R	≤4.0	0.16(0.10–0.20)
		●●✚	MP6130,VP15TF	M,R	≤4.0	0.13(0.10–0.15)
	Acier carbone Alliage acier Acier outil Dureté 280–350HB ≤350HB (recuit)	●	MP6120	L,M	≤3.0	0.13(0.10–0.15)
		●●	MP6130	L,M	≤3.0	0.13(0.10–0.15)
		●●		M,R	≤3.0	0.16(0.10–0.20)
		●●✚	MP6130,VP15TF	M,R	≤3.0	0.13(0.10–0.15)
	Acier pré-traité Dureté 35–45HRC	●	MP6120	L,M	≤2.0	0.13(0.10–0.15)
		●●	MP6130	L,M	≤2.0	0.13(0.10–0.15)
		●●		M,R	≤2.0	0.16(0.10–0.20)
		●●✚	MP6130,VP15TF	M,R	≤2.0	0.13(0.10–0.15)
M	Acier inoxydable austénitique Dureté ≤200HB	●●	MP7130	L,M	≤4.0	0.13(0.10–0.15)
		●●	VP15TF	M	≤4.0	0.16(0.10–0.20)
		●●✚	MP7130,VP15TF	M	≤4.0	0.13(0.10–0.15)
	Acier inoxydable austénitique Dureté >200HB	●	MP7130	L,M	≤4.0	0.13(0.10–0.15)
		●●	MP7130	L,M	≤3.0	0.13(0.10–0.15)
		●●	VP15TF	M	≤3.0	0.16(0.10–0.20)
		●●✚	MP7130,VP15TF	M	≤3.0	0.13(0.10–0.15)
	Aciers inoxydables ferritiques et martensitiques Dureté ≤200HB	●●	MP7130	L,M	≤4.0	0.13(0.10–0.15)
		●●	VP15TF	M	≤4.0	0.16(0.10–0.20)
		●●✚	MP7130,VP15TF	M	≤3.0	0.13(0.10–0.15)
	Acier inoxydable duplex Dureté ≤280HB	●●	MP7130	L,M	≤3.0	0.13(0.10–0.15)
		●●	MP7130	L,M	≤4.0	0.13(0.10–0.15)
		●●	VP15TF	M	≤3.0	0.16(0.10–0.20)
		●●	VP15TF	M	≤4.0	0.16(0.10–0.20)
		●●✚	MP7130,VP15TF	M	≤3.0	0.13(0.10–0.15)
		●●✚	MP7130,VP15TF	M	≤4.0	0.13(0.10–0.15)
Acier inoxydable à durcissement structural Dureté <450HB	●	MP7130	L,M	≤2.0	0.13(0.10–0.15)	
	●●	MP7130	L,M	≤2.0	0.13(0.10–0.15)	
	●●	VP15TF	M	≤2.0	0.16(0.10–0.20)	
	●●✚	MP7130,VP15TF	M	≤2.0	0.13(0.10–0.15)	
K	Fonte grise Résistance à la traction ≤350MPa	●●	MC5020	L,M	≤4.0	0.13(0.10–0.15)
		●●	VP15TF	M,R	≤4.0	0.16(0.10–0.20)
		●●✚	MC5020,VP15TF	M,R	≤4.0	0.13(0.10–0.15)
	Fonte ductile Résistance à la traction ≤800MPa	●●	MC5020	L,M	≤4.0	0.13(0.10–0.15)
		●●	VP15TF	M,R	≤4.0	0.16(0.10–0.20)
		●●✚	MC5020,VP15TF	M,R	≤4.0	0.13(0.10–0.15)
N	Alliage aluminium Teneur en silicium Si <5%	●●●	TF15	L	≤4.0	0.13(0.10–0.15)
S	Alliage titane –	●●	MP9120	L,M	≤2.0	0.10(0.05–0.13)
		●●✚	MP9130	L,M	≤2.0	0.10(0.05–0.13)
	Alliage réfractaire –	●●	MP9120	L,M	≤2.0	0.10(0.05–0.13)
		●●✚	MP9130	L,M	≤2.0	0.10(0.05–0.13)
H	Acier trempé Dureté 40–55HRC	●	VP15TF	M	≤2.0	0.05(0.05–0.10)
		●	VP15TF	M,R	≤2.0	0.05(0.05–0.10)

Remarque 1) Veuillez vous reporter au tableau ci-dessus pour les conditions de coupe.

Conditions de coupe (Guide) :

● : Coupe Stable ● : Coupe Générale ✚ : Coupe Instable

(mm)

	ae						Lubrification
	0.8DC ≥			DC(rainure)			
	Brise-copeaux	ap	fz (mm/dent)	Brise-copeaux	ap	fz (mm/dent)	
L,M	≤3.0	0.13(0.10-0.15)	L,M	≤2.0	0.13(0.10-0.15)	Sans, Avec	
L,M	≤3.0	0.13(0.10-0.15)	L,M	≤2.0	0.13(0.10-0.15)	Sans, Avec	
M,R	≤3.0	0.16(0.10-0.20)	-	-	-	Sans, Avec	
M,R	≤3.0	0.13(0.10-0.15)	M	≤2.0	0.13(0.10-0.15)	Sans, Avec	
L,M	≤3.0	0.13(0.10-0.15)	L,M	≤2.0	0.13(0.10-0.15)	Sans, Avec	
L,M	≤3.0	0.13(0.10-0.15)	L,M	≤2.0	0.13(0.10-0.15)	Sans, Avec	
M,R	≤3.0	0.16(0.10-0.20)	-	-	-	Sans, Avec	
M,R	≤3.0	0.13(0.10-0.15)	M	≤2.0	0.13(0.10-0.15)	Sans, Avec	
L,M	≤3.0	0.13(0.10-0.15)	L,M	≤3.0	0.13(0.10-0.15)	Sans, Avec	
L,M	≤3.0	0.13(0.10-0.15)	L,M	≤2.0	0.13(0.10-0.15)	Sans, Avec	
M,R	≤3.0	0.16(0.10-0.20)	-	-	-	Sans, Avec	
M,R	≤3.0	0.13(0.10-0.15)	M	≤2.0	0.13(0.10-0.15)	Sans, Avec	
-	-	-	-	-	-	Sans, Avec	
-	-	-	-	-	-	Sans, Avec	
-	-	-	-	-	-	Sans, Avec	
-	-	-	-	-	-	Sans, Avec	
L,M	≤3.0	0.13(0.10-0.15)	-	-	-	Sans, Avec	
M	≤3.0	0.16(0.10-0.20)	-	-	-	Sans, Avec	
M	≤3.0	0.13(0.10-0.15)	-	-	-	Sans, Avec	
L,M	≤3.0	0.13(0.10-0.15)	-	-	-	Sans, Avec	
L,M	≤3.0	0.13(0.10-0.15)	-	-	-	Sans, Avec	
M	≤3.0	0.16(0.10-0.20)	-	-	-	Sans, Avec	
M	≤3.0	0.13(0.10-0.15)	-	-	-	Sans, Avec	
L,M	≤3.0	0.13(0.10-0.15)	-	-	-	Sans, Avec	
M	≤3.0	0.16(0.10-0.20)	-	-	-	Sans, Avec	
M	≤3.0	0.13(0.10-0.15)	-	-	-	Sans, Avec	
L,M	≤3.0	0.13(0.10-0.15)	-	-	-	Sans	
L,M	≤3.0	0.13(0.10-0.15)	-	-	-	Avec	
M	≤3.0	0.16(0.10-0.20)	-	-	-	Sans	
M	≤3.0	0.16(0.10-0.20)	-	-	-	Avec	
M	≤3.0	0.16(0.10-0.20)	-	-	-	Sans	
M	≤3.0	0.13(0.10-0.15)	-	-	-	Avec	
-	-	-	-	-	-	Sans, Avec	
-	-	-	-	-	-	Sans, Avec	
-	-	-	-	-	-	Sans, Avec	
-	-	-	-	-	-	Sans, Avec	
L,M	≤3.0	0.13(0.10-0.15)	L,M	≤2.0	0.13(0.10-0.15)	Sans, Avec	
M,R	≤3.0	0.16(0.10-0.20)	-	-	-	Sans, Avec	
M,R	≤3.0	0.13(0.10-0.15)	M,R	≤2.0	0.13(0.10-0.15)	Sans, Avec	
L,M	≤3.0	0.13(0.10-0.15)	L,M	≤2.0	0.13(0.10-0.15)	Sans, Avec	
M,R	≤3.0	0.16(0.10-0.20)	-	-	-	Sans, Avec	
M,R	≤3.0	0.13(0.10-0.15)	M,R	≤2.0	0.13(0.10-0.15)	Sans, Avec	
L	≤3.0	0.13(0.10-0.15)	L	≤2.0	0.13(0.10-0.15)	Avec	
-	-	-	-	-	0.10(0.05-0.13)	Avec	
-	-	-	-	-	0.10(0.05-0.13)	Avec	
-	-	-	-	-	0.10(0.05-0.13)	Avec	
-	-	-	-	-	0.10(0.05-0.13)	Avec	
-	-	-	-	-	0.05(0.05-0.10)	Sans, Avec	
-	-	-	-	-	0.05(0.05-0.10)	Sans, Avec	

K
FRAISES À PLAQUETTES

FRAISES À PLAQUETTES

K
FRAISES À PLAQUETTES

■ Ramping / Interpolation Hélicoïdale

● Ramping

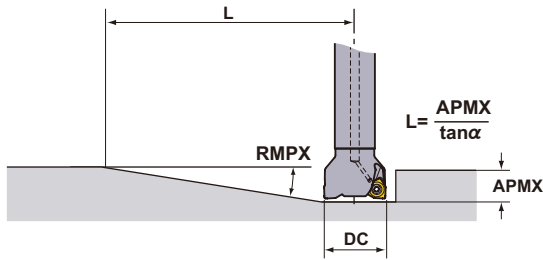

● Interpolation Hélicoïdale

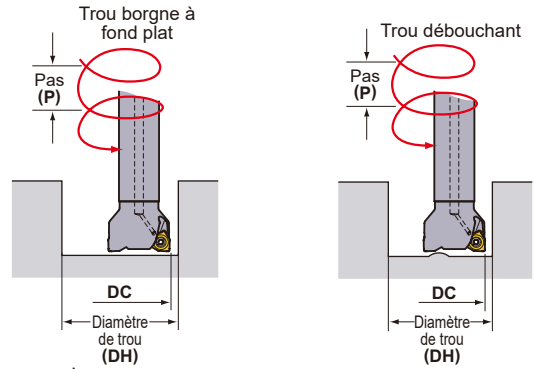

Se référer au tableau ci-dessous pour les conditions de coupe.

Pour l'avance par dent et la vitesse de coupe, se référer aux conditions de coupe pour rainurage.

(mm)

DC	RE	APMX	Ramping		Interpolation hélicoïdale (Trou borgne à fond plat)				Interpolation hélicoïdale (Trou débouchant)	
			RMPX	L *	DH max.	P max.	DH min.	P max.	DH min.	P max.
50	0.4	8	0.40°	1175	98.5	1.06	95.2	0.99	82.5	0.7
50	0.8	8	0.40°	1175	97.7	1.05	95.2	0.99	82.5	0.7
63	0.4	8	0.26°	1807	124.5	0.88	121.2	0.83	108.6	0.6
63	0.8	8	0.26°	1807	123.7	0.87	121.2	0.83	108.6	0.6
80	0.4	8	0.16°	2936	158.5	0.69	155.2	0.66	142.6	0.5
80	0.8	8	0.16°	2936	157.7	0.68	155.3	0.66	142.6	0.5

DC = Diamètre de coupe

RMPX = Angle de rampe maximale

P = Pas

APMX = Profondeur de coupe maximale

DH = Diamètre de trou désiré

Remarque 1) Pour le ramping et le fraisage hélicoïdal, il est recommandé de réduire l'avance par dent.

Remarque 2) Attention à la formation de copeaux longs en ramping et fraisage hélicoïdal.

Fraisage hélicoïdal :

Pour obtenir un fond plat en fraisage hélicoïdal, retirez le téton central résiduel lors d'une passe de finition.

En fraisage hélicoïdal, assurez-vous que la profondeur de passe reste inférieure à la profondeur de passe maximale (APMX).

● Plongée

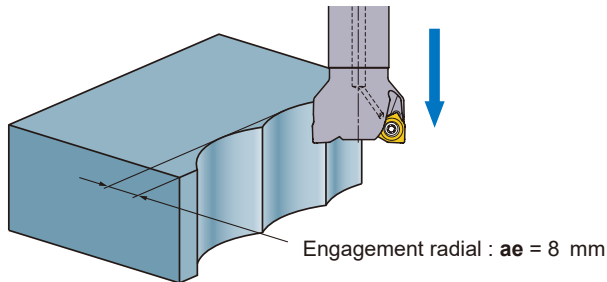

FRAISES À SURFACER-DRESSER

TRÈS HAUTE PRODUCTIVITÉ DANS LA FONTE



VOX400

P M **K** N S H



Fig.1

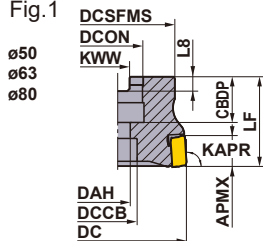

Fig.2

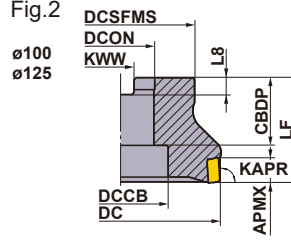
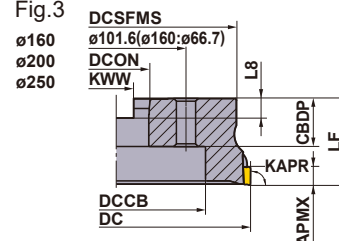

Fig.3



Outil à droite uniquement.

ATTACHEMENT PAR ALÉSAGE

KAPR : 90°

GAMP: -6° GAMF: -18°

Type	Order Number	Stock	Nombre de dents	Dimensions (mm)								*2	WT (kg)	APMX (mm)	Fig.	*1	
				DC	LF	DCON	CBDP	DAH	DCCB	DCSFMS	KWW					L8	Vis de serrage
Pas normal	VOX400-050A03R	●	3	50	40	22	20	11	17	41	10.4	6.3	0.3	10	1	CS401160T	TKY15T
	VOX400-063A04R	●	4	63	40	22	20	11	17	50	10.4	6.3	0.6	10	1	CS401160T	TKY15T
	VOX400-080A04R	●	4	80	50	27	23	13	20	56	12.4	7	1	10	1	CS401160T	TKY15T
	VOX400-100B06R	●	6	100	50	32	32	—	45	78	14.4	8	1.7	10	2	CS401160T	TKY15T
	VOX400-125B08R	●	8	125	63	40	32	—	56	89	16.4	9	3	10	2	CS401160T	TKY15T
	VOX400-160C10R	●	10	160	63	40	29	—	56	120	16.4	9	5.4	10	3	CS401160T	TKY15T
	VOX400-200C12R	●	12	200	63	60	32	—	130	175	25.7	14.22	8.1	10	3	CS401160T	TKY15T
VOX400-250C16R	●	16	250	63	60	32	—	180	210	25.7	14.22	11.8	10	3	CS401160T	TKY15T	
Pas réduit	VOX400-050A05R	●	5	50	40	22	20	11	17	41	10.4	6.3	0.3	10	1	CS401160T	TKY15T
	VOX400-063A06R	●	6	63	40	22	20	11	17	50	10.4	6.3	0.6	10	1	CS401160T	TKY15T
	VOX400-080A08R	●	8	80	50	27	23	13	20	56	12.4	7	1	10	1	CS401160T	TKY15T
	VOX400-100B10R	●	10	100	50	32	32	—	45	78	14.4	8	1.7	10	2	CS401160T	TKY15T
	VOX400-125B12R	●	12	125	63	40	32	—	56	89	16.4	9	3	10	2	CS401160T	TKY15T
	VOX400-160C16R	●	16	160	63	40	29	—	56	120	16.4	9	5.4	10	3	CS401160T	TKY15T
	VOX400-200C20R	●	20	200	63	60	32	—	130	175	25.7	14.22	8.1	10	3	CS401160T	TKY15T
VOX400-250C24R	●	24	250	63	60	32	—	180	210	25.7	14.22	11.8	10	3	CS401160T	TKY15T	
Pas extra fin	VOX400-063A08R	●	8	63	40	22	20	11	17	50	10.4	6.3	0.5	10	1	CS401160T	TKY15T
	VOX400-080A10R	●	10	80	50	27	23	13	20	56	12.4	7	1.0	10	1	CS401160T	TKY15T
	VOX400-100B12R	●	12	100	50	32	32	—	45	78	14.4	8	1.6	10	2	CS401160T	TKY15T
	VOX400-125B16R	●	16	125	63	40	32	—	56	89	16.4	9	2.8	10	2	CS401160T	TKY15T
	VOX400-160C20R	●	20	160	63	40	29	—	56	120	16.4	9	5.2	10	3	CS401160T	TKY15T
	VOX400-200C26R	★	26	200	63	60	32	—	130	175	25.7	14.22	7.9	10	3	CS401160T	TKY15T
VOX400-250C34R	★	34	250	63	60	32	—	180	210	25.7	14.22	11.5	10	3	CS401160T	TKY15T	

*1 Couple de serrage (N • m) : CS401160T=3,5

*2 WT : Poids de l'outil

K

FRAISES À PLAQUETTES

● : Article stocké. ★ : Article standard Japon.

PIÈCES DÉTACHÉES > N001
DONNÉES TECHNIQUES > P001

K065

FRAISES À PLAQUETTES

PLAQUETTES

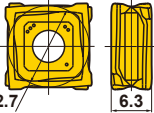
Matière	K Fonte		●	✦	Conditions de coupe (Guide) : ● : Coupe Stable ● : Coupe Générale ✦ : Coupe Instable	
	Forme	Référence				Classe
	SONX1206PER		N	E	● ●	 Outil représenté à droite.
	SONX1206PEL		N	E	★	

PLAQUETTES DE PLANAGE

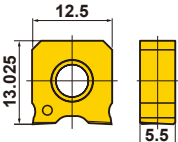
Matière	K Fonte		●	Conditions de coupe (Guide) : ● : Coupe Stable ● : Coupe Générale ✦ : Coupe Instable		
	Forme	Référence			Classe	Honing
	WOEX1206PER5C		E	E	●	

* Plaquette à gauche pour fraises 3 tailles (corps spéciaux).

K FRAISES À PLAQUETTES

CONDITIONS DE COUPE RECOMMANDÉES

■ VOX400 (Pas standard)

Matière	Résistance à la traction	Nuance	Vitesse de coupe (m/min)	φ 50 – φ 250		
				Profondeur de coupe radiale ae (mm)	Profondeur de passe ap (mm)	Avance par dent fz (mm/dent)
K Fonte grise	≤200MPa	MC5020	300(250–350)	≤DC	≤10	0.4(0.3–0.5)
		VP15TF	250(200–300)	≤DC	≤10	0.4(0.3–0.5)
	≤350MPa	MC5020	220(150–300)	≤DC	≤10	0.3(0.2–0.4)
		VP15TF	200(150–300)	≤DC	≤10	0.3(0.2–0.4)
Fonte ductile	≤450MPa	MC5020	200(150–250)	≤DC	≤10	0.3(0.2–0.4)
		VP15TF	170(150–200)	≤DC	≤10	0.3(0.2–0.4)
	≤800MPa	MC5020	170(150–200)	≤DC	≤10	0.2(0.1–0.3)
		VP15TF	150(100–200)	≤DC	≤10	0.2(0.1–0.3)

■ VOX400 (Pas réduit)

Matière	Résistance à la traction	Nuance	Vitesse de coupe (m/min)	φ 50, φ 63			φ 80		
				Profondeur de coupe radiale ae (mm)	Profondeur de passe ap (mm)	Avance par dent fz (mm/dent)	Profondeur de coupe radiale ae (mm)	Profondeur de passe ap (mm)	Avance par dent fz (mm/dent)
K Fonte grise	≤200MPa	MC5020	300(250–350)	≤DC	≤10	0.4(0.3–0.5)	≤DC	≤10	0.4(0.3–0.5)
		VP15TF	250(200–300)	≤DC	≤10	0.4(0.3–0.5)	≤DC	≤10	0.4(0.3–0.5)
	≤350MPa	MC5020	220(150–300)	≤DC	≤10	0.3(0.2–0.4)	≤DC	≤10	0.3(0.2–0.4)
		VP15TF	200(150–300)	≤DC	≤10	0.3(0.2–0.4)	≤DC	≤10	0.3(0.2–0.4)
Fonte ductile	≤450MPa	MC5020	200(150–250)	≤0.8DC	≤10	0.3(0.2–0.4)	≤0.6DC	≤10	0.3(0.2–0.4)
		VP15TF	170(150–200)	≤0.8DC	≤10	0.3(0.2–0.4)	≤0.6DC	≤10	0.3(0.2–0.4)
	≤800MPa	MC5020	170(150–200)	≤0.8DC	≤10	0.2(0.1–0.3)	≤0.6DC	≤10	0.2(0.1–0.3)
		VP15TF	150(100–200)	≤0.8DC	≤10	0.2(0.1–0.3)	≤0.6DC	≤10	0.2(0.1–0.3)

Matière	Résistance à la traction	Nuance	Vitesse de coupe (m/min)	φ 100			φ 125		
				Profondeur de coupe radiale ae (mm)	Profondeur de passe ap (mm)	Avance par dent fz (mm/dent)	Profondeur de coupe radiale ae (mm)	Profondeur de passe ap (mm)	Avance par dent fz (mm/dent)
K Fonte grise	≤200MPa	MC5020	300(250–350)	≤DC	≤10	0.4(0.3–0.5)	≤DC	≤10	0.4(0.3–0.5)
		VP15TF	250(200–300)	≤DC	≤10	0.4(0.3–0.5)	≤DC	≤10	0.4(0.3–0.5)
	≤350MPa	MC5020	220(150–300)	≤DC	≤10	0.3(0.2–0.4)	≤DC	≤10	0.3(0.2–0.4)
		VP15TF	200(150–300)	≤DC	≤10	0.3(0.2–0.4)	≤DC	≤10	0.3(0.2–0.4)
Fonte ductile	≤450MPa	MC5020	200(150–250)	≤0.5DC	≤10	0.3(0.2–0.4)	≤0.4DC	≤10	0.3(0.2–0.4)
		VP15TF	170(150–200)	≤0.5DC	≤10	0.3(0.2–0.4)	≤0.4DC	≤10	0.3(0.2–0.4)
	≤800MPa	MC5020	170(150–200)	≤0.5DC	≤10	0.2(0.1–0.3)	≤0.4DC	≤10	0.2(0.1–0.3)
		VP15TF	150(100–200)	≤0.5DC	≤10	0.2(0.1–0.3)	≤0.4DC	≤10	0.2(0.1–0.3)

● : Article stocké. ★ : Article standard Japon.

K066

(10 plaquettes par boîte)

Matière	Résistance à la traction	Nuance	Vitesse de coupe (m/min)	φ 160			φ 200–φ 250		
				Profondeur de coupe radiale ae (mm)	Profondeur de passe ap (mm)	Avance par dent fz (mm/dent)	Profondeur de coupe radiale ae (mm)	Profondeur de passe ap (mm)	Avance par dent fz (mm/dent)
Fonte grise	≤200MPa	MC5020	300(250–350)	≤DC	≤10	0.4(0.3–0.5)	≤DC	≤10	0.4(0.3–0.5)
		VP15TF	250(200–300)	≤DC	≤10	0.4(0.3–0.5)	≤DC	≤10	0.4(0.3–0.5)
	≤350MPa	MC5020	220(150–300)	≤DC	≤10	0.3(0.2–0.4)	≤DC	≤10	0.3(0.2–0.4)
		VP15TF	200(150–300)	≤DC	≤10	0.3(0.2–0.4)	≤DC	≤10	0.3(0.2–0.4)
Fonte ductile	≤450MPa	MC5020	200(150–250)	≤0.3DC	≤10	0.3(0.2–0.4)	≤0.2DC	≤10	0.3(0.2–0.4)
		VP15TF	170(150–200)	≤0.3DC	≤10	0.3(0.2–0.4)	≤0.2DC	≤10	0.3(0.2–0.4)
	≤800MPa	MC5020	170(150–200)	≤0.3DC	≤10	0.2(0.1–0.3)	≤0.2DC	≤10	0.2(0.1–0.3)
		VP15TF	150(100–200)	≤0.3DC	≤10	0.2(0.1–0.3)	≤0.2DC	≤10	0.2(0.1–0.3)

Remarque 1) DC est le diamètre de la fraise.

Remarque 2) Si vous utilisez une plaquette de planage, réduisez l'avance à la dent de moitié par rapport à la vitesse normale.

■ VOX400 (Pas extra fin)

Matière	Résistance à la traction	Nuance	Vitesse de coupe (m/min)	φ 63			φ 80		
				Profondeur de coupe radiale ae (mm)	Profondeur de passe ap (mm)	Avance par dent fz (mm/dent)	Profondeur de coupe radiale ae (mm)	Profondeur de passe ap (mm)	Avance par dent fz (mm/dent)
Fonte grise	≤200MPa	MC5020	300(250–350)	≤DC	≤10	0.4(0.3–0.5)	≤DC	≤10	0.4(0.3–0.5)
		VP15TF	250(200–300)	≤DC	≤10	0.4(0.3–0.5)	≤DC	≤10	0.4(0.3–0.5)
	≤350MPa	MC5020	220(150–300)	≤DC	≤10	0.3(0.2–0.4)	≤DC	≤10	0.3(0.2–0.4)
		VP15TF	200(150–300)	≤DC	≤10	0.3(0.2–0.4)	≤DC	≤10	0.3(0.2–0.4)
Fonte ductile	≤450MPa	MC5020	200(150–250)	≤0.6DC	≤10	0.3(0.2–0.4)	≤0.5DC	≤10	0.3(0.2–0.4)
		VP15TF	170(150–200)	≤0.6DC	≤10	0.3(0.2–0.4)	≤0.5DC	≤10	0.3(0.2–0.4)
	≤800MPa	MC5020	170(150–200)	≤0.6DC	≤10	0.2(0.1–0.3)	≤0.5DC	≤10	0.2(0.1–0.3)
		VP15TF	150(100–200)	≤0.6DC	≤10	0.2(0.1–0.3)	≤0.5DC	≤10	0.2(0.1–0.3)

Matière	Résistance à la traction	Nuance	Vitesse de coupe (m/min)	φ 100			φ 125		
				Profondeur de coupe radiale ae (mm)	Profondeur de passe ap (mm)	Avance par dent fz (mm/dent)	Profondeur de coupe radiale ae (mm)	Profondeur de passe ap (mm)	Avance par dent fz (mm/dent)
Fonte grise	≤200MPa	MC5020	300(250–350)	≤DC	≤10	0.4(0.3–0.5)	≤DC	≤10	0.4(0.3–0.5)
		VP15TF	250(200–300)	≤DC	≤10	0.4(0.3–0.5)	≤DC	≤10	0.4(0.3–0.5)
	≤350MPa	MC5020	220(150–300)	≤DC	≤10	0.3(0.2–0.4)	≤DC	≤10	0.3(0.2–0.4)
		VP15TF	200(150–300)	≤DC	≤10	0.3(0.2–0.4)	≤DC	≤10	0.3(0.2–0.4)
Fonte ductile	≤450MPa	MC5020	200(150–250)	≤0.4DC	≤10	0.3(0.2–0.4)	≤0.3DC	≤10	0.3(0.2–0.4)
		VP15TF	170(150–200)	≤0.4DC	≤10	0.3(0.2–0.4)	≤0.3DC	≤10	0.3(0.2–0.4)
	≤800MPa	MC5020	170(150–200)	≤0.4DC	≤10	0.2(0.1–0.3)	≤0.3DC	≤10	0.2(0.1–0.3)
		VP15TF	150(100–200)	≤0.4DC	≤10	0.2(0.1–0.3)	≤0.3DC	≤10	0.2(0.1–0.3)

Matière	Résistance à la traction	Nuance	Vitesse de coupe (m/min)	φ 160			φ 200–φ 250		
				Profondeur de coupe radiale ae (mm)	Profondeur de passe ap (mm)	Avance par dent fz (mm/dent)	Profondeur de coupe radiale ae (mm)	Profondeur de passe ap (mm)	Avance par dent fz (mm/dent)
Fonte grise	≤200MPa	MC5020	300(250–350)	≤DC	≤10	0.4(0.3–0.5)	≤DC	≤10	0.4(0.3–0.5)
		VP15TF	250(200–300)	≤DC	≤10	0.4(0.3–0.5)	≤DC	≤10	0.4(0.3–0.5)
	≤350MPa	MC5020	220(150–300)	≤DC	≤10	0.3(0.2–0.4)	≤DC	≤10	0.3(0.2–0.4)
		VP15TF	200(150–300)	≤DC	≤10	0.3(0.2–0.4)	≤DC	≤10	0.3(0.2–0.4)
Fonte ductile	≤450MPa	MC5020	200(150–250)	≤0.25DC	≤10	0.3(0.2–0.4)	≤0.15DC	≤10	0.3(0.2–0.4)
		VP15TF	170(150–200)	≤0.25DC	≤10	0.3(0.2–0.4)	≤0.15DC	≤10	0.3(0.2–0.4)
	≤800MPa	MC5020	170(150–200)	≤0.25DC	≤10	0.2(0.1–0.3)	≤0.15DC	≤10	0.2(0.1–0.3)
		VP15TF	150(100–200)	≤0.25DC	≤10	0.2(0.1–0.3)	≤0.15DC	≤10	0.2(0.1–0.3)

Remarque 1) DC est le diamètre de la fraise.

Remarque 2) Si vous utilisez une plaquette de planage, réduisez l'avance à la dent de moitié par rapport à la vitesse normale.

FRAISES À PLAQUETTES

FRAISES À SURFACER-DRESSER

<FRAISAGE EN GÉNÉRAL>



ASX400

P M K N S H

K

FRAISES À PLAQUETTES



ATTACHEMENT PAR ALÉSAGE

KAPR : 90°

GAMP: +11° GAMF: -9° - -11°

Sans trous d'arrosage

Fig.1

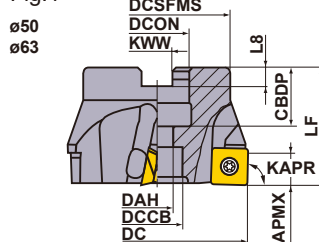

Fig.2

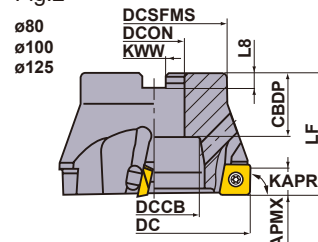

Fig.3

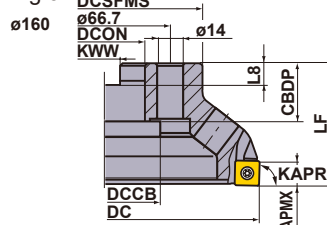
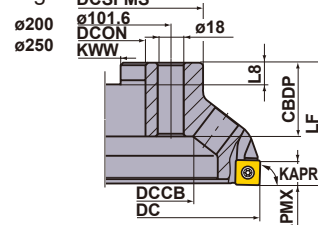

Fig.4



Porte-outil à droite uniquement.

Type	Référence	Stock	Nombre de dents	Dimensions (mm)									WT*	APMX (mm)	Fig.
				DC	LF	DCON	CBDP	DAH	DCCB	DCSFMS	KWW	L8			
Pas normal	ASX400-050A03R	●	3	50	40	22	20	11	17	41	10.4	6.3	0.3	10	1
	ASX400-063A04R	●	4	63	40	22	20	11	17	50	10.4	6.3	0.5	10	1
	ASX400-080B04R	●	4	80	50	27	29	—	38	60	12.4	7	0.9	10	2
	ASX400-100B05R	●	5	100	50	32	32	—	45	70	14.4	8	1.4	10	2
	ASX400-125B06R	●	6	125	63	40	32	—	60	80	16.4	9	2.3	10	2
	ASX400-160C08R	●	8	160	63	40	29	—	56	100	16.4	9	3.6	10	3
	ASX400-200C10R	●	10	200	63	60	32	—	135	160	25.7	14.22	6.3	10	4
	ASX400-250C12R	●	12	250	63	60	32	—	180	210	25.7	14.22	10.8	10	4
Pas réduit	ASX400-050A04R	●	4	50	40	22	20	11	17	41	10.4	6.3	0.3	10	1
	ASX400-063A05R	●	5	63	40	22	20	11	17	50	10.4	6.3	0.5	10	1
	ASX400-080B06R	●	6	80	50	27	29	—	38	60	12.4	7	0.9	10	2
	ASX400-100B07R	●	7	100	50	32	32	—	45	70	14.4	8	1.4	10	2
	ASX400-125B08R	●	8	125	63	40	32	—	60	80	16.4	9	2.2	10	2
	ASX400-160C12R	●	12	160	63	40	29	—	56	100	16.4	9	3.5	10	3
	ASX400-200C16R	●	16	200	63	60	32	—	135	160	25.7	14.22	6.2	10	4
	ASX400-250C18R	●	18	250	63	60	32	—	180	210	25.7	14.22	10.7	10	4
Pas extra fin	ASX400-050A05R	●	5	50	40	22	20	11	17	41	10.4	6.3	0.3	10	1
	ASX400-063A06R	●	6	63	40	22	20	11	17	50	10.4	6.3	0.5	10	1
	ASX400-080B08R	●	8	80	50	27	29	—	38	60	12.4	7	0.9	10	2
	ASX400-100B10R	●	10	100	50	32	32	—	45	70	14.4	8	1.4	10	2
	ASX400-125B12R	●	12	125	63	40	32	—	60	80	16.4	9	2.1	10	2
	ASX400-160C15R	●	15	160	63	40	29	—	56	100	16.4	9	3.4	10	3
	ASX400-200C19R	★	19	200	63	60	32	—	135	160	25.7	14.22	6.2	10	4
	ASX400-250C22R	★	22	250	63	60	32	—	180	210	25.7	14.22	10.5	10	4

* WT : Poids de l'outil

● : Article stocké. ★ : Article standard Japon.

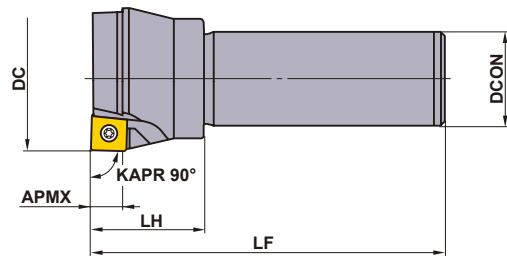
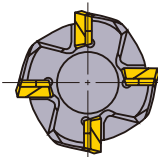





ATTACHEMENT CYLINDRIQUE

Outil à droite uniquement.

Type	Référence	Stock R	Nombre de dents	Dimensions (mm)				
				DC	LF	DCON	LH	APMX
Pas normal	ASX400R403S32	★	3	40	125	32	40	10
Pas réduit	ASX400R504S32	★	4	50	125	32	40	10
	ASX400R635S32	★	5	63	125	32	40	10

PIÈCES DÉTACHÉES



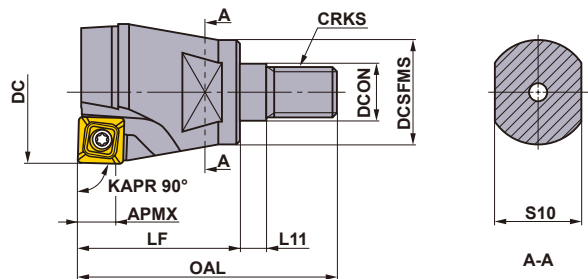
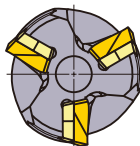

Référence porte-outil		 *	 *		
	Assise	Vis assise	Vis de fixation	Clé (Plaquette)	Clé (Assise)
ASX400	STASX400N	WCS503507H	TPS35	TIP15T	HKY35R

* Couple de serrage (N • m) : WCS503507H=5,0, TPS35=3,5



FRAISE À EMBOUT FILETÉ

Outil à droite uniquement.

Référence	Stock R	Nombre de dents	Dimensions (mm)									*2 WT (kg)		 *1	 *1		
			DC	DCON	DCSFMS	OAL	LF	L11	S10	CRKS	APMX		Assise	Vis assise	Vis de fixation	Clé (Plaquette)	Clé (Assise)
ASX400R322M16	●	2	32	17	29	65	42	6	22	M16	10	0.3	—	WCS503507H	TPS35	TIP15T	HKY35R
ASX400R403M16	●	3	40	17	29	70	47	6	22	M16	10	0.3	STASX400N	WCS503507H	TPS35	TIP15T	HKY35R

*1 Couple de serrage (N • m) : WCS503507H=5,0, TPS35=3,5

*2 WT : Poids de l'outil

Remarque 1) Pour les arbres vissables, veuillez vous référer à la page K244.

FRAISES À PLAQUETTES

PLAQUETTES

Matière	P Acier		M Acier Inoxydable		K Fonte		N Non ferreux		S Alliage réfractaire, Alliage titane		H Acier trempé		Conditions de coupe (Guide) :										
											● : Coupe Stable ● : Coupe Générale ✦ : Coupe Instable Honing : E : Ronde F : Affûtée T : Chanfrein												
Application	Forme	Référence	Classe	Honing	Revêtu										Cermet	Carbure	Dimensions (mm)					Géométrie	
					F7030	MC5020	MP6120	MP6130	MP7130	MP7140	MP9120	MP9130	VP15TF	VP30RT	NX4545	NX2525	HTi10	HTi05T	L	IC	S		BS
Finition - Semi finition	JL Brise-copeaux	SOET12T308PEER-JL	E	E	●	●	●	●	●	●	●	●	●	●	●	●	●	-	12.7	3.97	1.4	0.8	
Semi finition - Ébauche	JM Brise-copeaux	SOMT12T308PEER-JM	M	E	●	●	●	●	●	●	●	●	●	●	●	●	●	-	12.7	3.97	1.4	0.8	
		SOMT12T308PEEL-JM	M	E														-	12.7	3.97	1.4	0.8	 Outil représenté à droite.
Ébauche moyenne - Traux courts	JH Brise-copeaux	SOMT12T308PEER-JH	M	E	●	●	●	●	●	●	●	●	●	●	●	●	●	-	12.7	3.97	1.4	0.8	
Coupe fortement interrompue	FT Brise-copeaux	SOMT12T320PEER-FT	M	E	●	●					★	★	●					-	12.7	3.97	0.5	2.0	
Pour alliage aluminium	JP Brise-copeaux	SOGT12T308PEFR-JP	G	F												●	-	12.7	3.97	1.4	0.8		
Arasage		WOEW12T308PEER8C	E	E												●	13.2	-	3.97	8	0.8		
		WOEW12T308PETR8C	E	T												●	13.2	-	3.97	8	0.8		

K

FRAISES À PLAQUETTES

● : Article stocké. ★ : Article standard Japon.
(10 plaquettes par boîte)

K070

CONDITIONS DE COUPE RECOMMANDÉES

Matériau	Dureté	Nuance	Vitesse de coupe (m/min)	Finition – Semi finition		Semi finition – Ébauche		Ébauche moyenne – Travaux lourds		
				Avance par dent (mm/dent)	Brise-copeaux	Avance par dent (mm/dent)	Brise-copeaux	Avance par dent (mm/dent)	Brise-copeaux	
P	Acier doux	F7030	280 (210–350)	0.18 (0.08–0.28)	JL	0.20 (0.10–0.30)	JM	0.25 (0.10–0.35)	JH	
		MP6120 VP15TF	250 (200–300)	0.18 (0.08–0.28)	JL	0.20 (0.10–0.30)	JM	0.25 (0.10–0.35)	JH FT	
		MP6130	240 (190–290)	0.18 (0.08–0.28)	JL	0.20 (0.10–0.30)	JM	0.25 (0.10–0.35)	JH	
		VP30RT	230 (180–280)	0.18 (0.08–0.28)	JL	0.20 (0.10–0.30)	JM	0.25 (0.10–0.35)	JH	
		NX4545	180 (130–230)	0.15 (0.07–0.23)	JL	0.18 (0.10–0.28)	JM	–	–	
	Acier carbone Alliage acier	180–280HB	F7030	250 (200–300)	0.15 (0.07–0.23)	JL	0.18 (0.10–0.28)	JM	0.20 (0.10–0.30)	JH
			MP6120 VP15TF	220 (170–270)	0.15 (0.07–0.23)	JL	0.18 (0.10–0.28)	JM	0.20 (0.10–0.30)	JH FT
			MP6130	180 (150–230)	0.15 (0.07–0.23)	JL	0.18 (0.10–0.28)	JM	0.20 (0.10–0.30)	JH
			VP30RT	150 (120–180)	0.15 (0.07–0.23)	JL	0.18 (0.10–0.28)	JM	0.20 (0.10–0.30)	JH
			NX4545	150 (120–180)	0.13 (0.06–0.20)	JL	0.15 (0.10–0.25)	JM	–	–
280–350HB		F7030	180 (130–230)	0.13 (0.06–0.20)	JL	0.15 (0.10–0.25)	JM	0.18 (0.10–0.28)	JH	
		MP6120 VP15TF	140 (100–180)	0.13 (0.06–0.20)	JL	0.15 (0.10–0.25)	JM	0.18 (0.10–0.28)	JH FT	
		MP6130	120 (90–150)	0.13 (0.06–0.20)	JL	0.15 (0.10–0.25)	JM	0.18 (0.10–0.28)	JH	
		VP30RT	100 (80–160)	0.13 (0.06–0.20)	JL	0.15 (0.10–0.25)	JM	0.18 (0.10–0.28)	JH	
		NX4545	100 (80–160)	0.10 (0.05–0.15)	JL	0.13 (0.10–0.20)	JM	–	–	
M	Acier inoxydable	MP7130 VP15TF	220 (170–270)	0.15 (0.07–0.23)	JL	0.18 (0.10–0.28)	JM	0.20 (0.10–0.30)	JH FT	
		MP7140 VP30RT	200 (150–250)	0.15 (0.07–0.23)	JL	0.18 (0.10–0.28)	JM	0.20 (0.10–0.30)	JH	
		NX4545	150 (120–180)	0.15 (0.07–0.23)	JL	0.18 (0.10–0.28)	JM	–	–	
K	Fonte Fonte ductile	Résistance à la traction ≤450MPa	MC5020	200 (150–250)	–	–	0.20 (0.10–0.30)	JM	0.25 (0.10–0.35)	JH FT
			VP15TF	180 (130–230)	0.18 (0.10–0.28)	JL	0.20 (0.10–0.30)	JM	0.25 (0.10–0.35)	JH FT
N	Alliage aluminium	–	HTi10	650 (300–1000)	0.15 (0.10–0.20)	JP	0.20 (0.10–0.30)	JP	0.30 (0.20–0.40)	JP
S	Alliage titane	–	MP9120 VP15TF	50 (40–60)	0.12 (0.05–0.20)	JL	0.15 (0.05–0.20)	JM	0.18 (0.10–0.28)	JH FT
			MP9130	45 (30–55)	0.10 (0.05–0.20)	JL	0.15 (0.05–0.20)	JM	0.18 (0.10–0.28)	JH FT
	Alliage réfractaire (Inconel etc.)	–	MP9120 VP15TF	40 (20–50)	0.12 (0.05–0.20)	JL	0.15 (0.05–0.20)	JM	0.18 (0.10–0.28)	JH FT
			MP9130	35 (15–45)	0.10 (0.05–0.20)	JL	0.15 (0.05–0.20)	JM	0.18 (0.10–0.28)	JH FT
H	Acier Traité	40–55HRC	VP15TF	80 (60–100)	0.08 (0.04–0.13)	JL	0.10 (0.05–0.15)	JM	0.12 (0.07–0.17)	JH FT

● Régime (min⁻¹) = (1000 x Vitesse de coupe) ÷ (3.14 x DC)

● Avance table (mm/min) = Avance par dent x Nombre de dents x Régime

RECOMMANDATIONS POUR L'UTILISATION DES PLAQUETTES

■ Instructions pour l'utilisation du brise-copeaux JP

- Le brise-copeaux JP a les arêtes de coupe affûtées. A manipuler avec des gants.
- En usinage d'alliage aluminium, on a tendance à avoir le phénomène d'arête rapportée, qui provoque la casse de la plaquette. Pour prévenir, l'usinage à sec est recommandé.



■ Instructions pour l'utilisation des plaquettes de planage

- Les plaquettes de planage pour ASX400 possèdent une seule arête.
- Lors du montage de la plaquette de planage, placez la plaquette de sorte que le petit chanfrein soit positionné comme indiqué.
- L'arête principale de la plaquette de planage est positionnée sur un rayon inférieur que celui des plaquettes d'ébauche. Attention à l'écaillage de la plaquette qui suit la plaquette de planage.
- Lors de l'utilisation de la plaquette de planage, veuillez vous référer aux conditions de coupe indiquées. Profondeur de coupe (ap) ≤ 0,5 mm, avance par dent (fz) ≤ 0,2 mm/t.

K

FRAISES À PLAQUETTES

FRAISES À PLAQUETTES

FRAISES MULTI FONCTIONS



WJX09

NEW

P M K N S H

K

FRAISES À PLAQUETTES



Fig.1
ø40

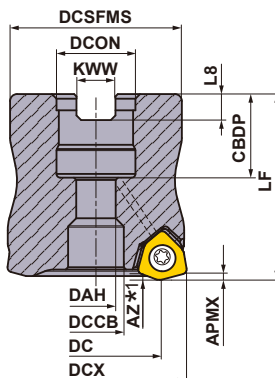
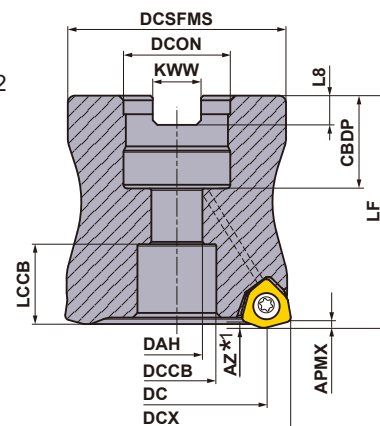

Fig.2
ø50
ø52
ø63
ø66



Outil à droite uniquement.

DCON (mm)	Vis d'attachement	Géométrie
ø16	HFF08033H	①
ø22	HSC10030H	②
ø27	HSC12035H	

ATTACHEMENT PAR ALÉSAGE

GAMP: -6° GAMF: -11° - -10°
Avec trous d'arrosage

DCX (mm)	Référence	Stock R	Nombre de dents	Dimensions (mm)			WT*2 (kg)	APMX (mm)	RPMX (min ⁻¹)	Fig.	Type Plaquette
				DC	LF	DCON					
40	WJX09-040A04AR	●	4	28.8	40	16	0.2	1.2	23200	1	JOMU0905
40	WJX09-040A05AR	●	5	28.8	40	16	0.2	1.2	23200	1	JOMU0905
50	WJX09-050A04AR	●	4	38.8	50	22	0.4	1.2	20000	2	JOMU0905
50	WJX09-050A06AR	●	6	38.8	50	22	0.4	1.2	20000	2	JOMU0905
52	WJX09-052A06AR	●	6	40.8	50	22	0.5	1.2	19500	2	JOMU0905
63	WJX09-063A05AR	●	5	51.8	50	22	0.8	1.2	17300	2	JOMU0905
63	WJX09-063A07AR	●	7	51.8	50	22	0.8	1.2	17300	2	JOMU0905
63	WJX09-063X07AR	●	7	51.8	50	27	0.7	1.2	17300	2	JOMU0905
66	WJX09-066X07AR	●	7	54.8	50	27	0.8	1.2	16800	2	JOMU0905

*1 Cf. page K077 pour la profondeur de perçage maximale (AZ).

*2 WT : Poids de l'outil

Remarque 1) Les vitesses de rotation maximum (RPMX) préconisées assurent fiabilité de l'outil et de la plaquette.

Remarque 2) Lorsque vous utilisez un outil en usinage à grande vitesse, assurez-vous que l'outil et l'attachement sont correctement équilibrés.

DIMENSIONS DE MONTAGE

DCX (mm)	Référence	Dimensions (mm)								Fig.
		DCON	CBDBP	DAH	DCCB	LCCB	DCSFMS	KWW	L8	
40	WJX09-040A04AR	16	18	8.5	12	—	37	8.4	5.6	1
40	WJX09-040A05AR	16	18	8.5	12	—	37	8.4	5.6	1
50	WJX09-050A04AR	22	20	11	17	17.2	47	10.4	6.3	2
50	WJX09-050A06AR	22	20	11	17	17.2	47	10.4	6.3	2
52	WJX09-052A06AR	22	20	11	17	17.2	47	10.4	6.3	2
63	WJX09-063A05AR	22	20	11	17	17.2	60	10.4	6.3	2
63	WJX09-063A07AR	22	20	11	17	17.2	60	10.4	6.3	2
63	WJX09-063X07AR	27	23	13	20	16.2	60	12.4	7	2
66	WJX09-066X07AR	27	23	13	20	16.2	60	12.4	7	2

● : Article stocké. ★ : Article standard Japon.

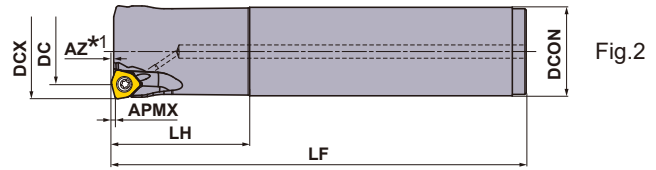
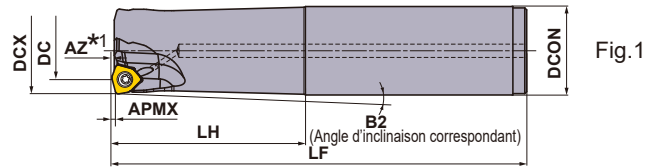

Outil à droite uniquement.

ATTACHEMENT CYLINDRIQUE

Avec trou de lubrification

DCX (mm)	Référence	Stock R	Nombre de dents	Dimensions (mm)					APMX (mm)	RPMX (min ⁻¹)	Fig.	Type Plaquette
				DC	LF	LH	DCON	B2				
25	WJX09R2502SA25S	●	2	14	140	60	25	1.09°	1.2	33500	1	JOMU0905
25	WJX09R2503SA25S	●	3	14	140	60	25	1.09°	1.2	33500	1	JOMU0905
25	WJX09R2502SA25L	●	2	14	200	120	25	0.54°	1.2	33500	1	JOMU0905
25	WJX09R2503SA25L	★	3	14	200	120	25	0.54°	1.2	33500	1	JOMU0905
25	WJX09R2502SA25EL	★	2	14	300	180	25	0.35°	1.2	33500	1	JOMU0905
28	WJX09R2802SA25S	★	2	16.9	140	40	25	—	1.2	30300	2	JOMU0905
28	WJX09R2803SA25S	●	3	16.9	140	40	25	—	1.2	30300	2	JOMU0905
28	WJX09R2802SA25L	●	2	16.9	200	40	25	—	1.2	30300	2	JOMU0905
28	WJX09R2803SA25L	★	3	16.9	200	40	25	—	1.2	30300	2	JOMU0905
28	WJX09R2802SA25EL	★	2	16.9	300	40	25	—	1.2	30300	2	JOMU0905
32	WJX09R3202SA32S	★	2	20.9	150	70	32	0.93°	1.2	27300	1	JOMU0905
32	WJX09R3203SA32S	●	3	20.9	150	70	32	0.93°	1.2	27300	1	JOMU0905
32	WJX09R3202SA32L	★	2	20.9	200	120	32	0.54°	1.2	27300	1	JOMU0905
32	WJX09R3203SA32L	●	3	20.9	200	120	32	0.54°	1.2	27300	1	JOMU0905
32	WJX09R3202SA32EL	★	2	20.9	300	180	32	0.35°	1.2	27300	1	JOMU0905
35	WJX09R3503SA32S	★	3	23.8	150	50	32	—	1.2	25500	2	JOMU0905
35	WJX09R3504SA32S	★	4	23.8	150	50	32	—	1.2	25500	2	JOMU0905
35	WJX09R3503SA32L	★	3	23.8	200	50	32	—	1.2	25500	2	JOMU0905
35	WJX09R3504SA32L	★	4	23.8	200	50	32	—	1.2	25500	2	JOMU0905
35	WJX09R3502SA32EL	★	2	23.8	300	50	32	—	1.2	25500	2	JOMU0905
40	WJX09R4003SA32S	★	3	28.8	150	50	32	—	1.2	23200	2	JOMU0905
40	WJX09R4004SA32S	●	4	28.8	150	50	32	—	1.2	23200	2	JOMU0905
40	WJX09R4003SA32L	★	3	28.8	250	50	32	—	1.2	23200	2	JOMU0905
40	WJX09R4004SA32L	★	4	28.8	250	50	32	—	1.2	23200	2	JOMU0905
40	WJX09R4003SA32EL	★	3	28.8	300	50	32	—	1.2	23200	2	JOMU0905

*1 Cf. page K077 pour la profondeur de perçage maximale (AZ).

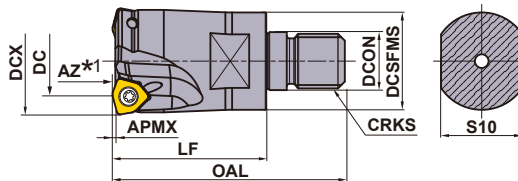

FRAISE À EMBOUT FILETÉ

Avec trous d'arrosage

Outil à droite uniquement.

DCX (mm)	Référence	Stock R	Nombre de dents	Dimensions (mm)							WT *2 (kg)	APMX (mm)	RPMX (min ⁻¹)	Type Plaquette
				DC	LF	OAL	DCON	DCSFMS	S10	CRKS				
25	WJX09R2502AM1235	●	2	14	35	57	12.5	23.5	19	M12	0.1	1.2	33500	JOMU0905
25	WJX09R2503AM1235	●	3	14	35	57	12.5	23.5	19	M12	0.1	1.2	33500	JOMU0905
28	WJX09R2802AM1235	●	2	16.9	35	57	12.5	23.5	19	M12	0.1	1.2	30300	JOMU0905
28	WJX09R2803AM1235	●	3	16.9	35	57	12.5	23.5	19	M12	0.1	1.2	30300	JOMU0905
32	WJX09R3202AM1645	●	2	20.9	45	68	17.0	28.5	24	M16	0.2	1.2	27300	JOMU0905
32	WJX09R3203AM1645	●	3	20.9	45	68	17.0	28.5	24	M16	0.2	1.2	27300	JOMU0905
35	WJX09R3502AM1645	●	2	23.8	45	68	17.0	28.5	24	M16	0.3	1.2	25500	JOMU0905
35	WJX09R3503AM1645	●	3	23.8	45	68	17.0	28.5	24	M16	0.2	1.2	25500	JOMU0905
35	WJX09R3504AM1645	●	4	23.8	35	68	17.0	28.5	24	M16	0.2	1.2	25500	JOMU0905
40	WJX09R4003AM1645	●	3	28.8	45	68	17.0	28.5	24	M16	0.3	1.2	23200	JOMU0905
40	WJX09R4004AM1645	●	4	28.8	45	68	17.0	28.5	24	M16	0.3	1.2	23200	JOMU0905
40	WJX09R4005AM1645	●	5	28.8	45	68	17.0	28.5	24	M16	0.3	1.2	23200	JOMU0905

*1 Cf. page K077 pour la profondeur de perçage maximale (AZ).



*2 WT : Poids de l'outil

Remarque 1) Pour les arbres vissables, veuillez vous référer à la page K244.

RALLONGES > K244
PIÈCES DÉTACHÉES > N001
DONNÉES TECHNIQUES > P001

FRAISES À PLAQUETTES

PIÈCES DÉTACHÉES



Porte-outil Type			
	Vis de fixation	Clé (Plaquette)	Anti-grippant
WJX09	TPS3R	TIP10D	MK1KS

* Couple de serrage TP3SR : 2,0 Nm

K

FRAISES À PLAQUETTES

PLAQUETTES

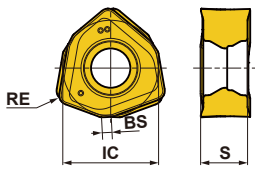
Matière	P	Acier	●	●	●	●	●	●	●	●	●	●	●	Conditions de coupe (Guide) : ● : Coupe Stable ● : Coupe Générale ✦ : Coupe Instable			
	M	Acier Inoxydable	●	●	●	●	●	●	●	●	●	●	●				
Forme	K	Fonte	●	●	●	●	●	●	●	●	●	●	Honing : E : Ronde	Géométrie			
	S	Alliage réfractaire, Alliage titane	●	●	●	●	●	●	●	●	●	●					
Référence	H	Matériaux durs	●	●	●	●	●	●	●	●	●	●	IC	S	BS	RE	Outil représenté à droite.
	Classe	Honing	Revêtu								Dimensions (mm)						
			MC7020	MP6120	MP6130	MP7130	MP7140	MP9120	MP9130	VP15TF	VP30RT						
 	JOMU090512ZZER-L	M	E	●	●	●	●	●	●	●	●	●	9.525	4.73	0.88	1.2	
	JOMU090512ZZER-M	M	E	●	●	●	●	●	●	●	●	●	9.525	4.75	0.88	1.2	
	JOMU090512ZZER-R	M	E	●	●	●	●	●	●	●	●	●	9.525	4.83	0.88	1.2	

● = NEW

■ Diamètre de la fraise et surfaces planes

Le diamètre de coupe maximal DCX indiqué dans le tableau des dimensions des fraises WJX n'est pas identique aux dimensions de la surface plane réalisée. Les dimensions de la surface plane sont données par le diamètre DC. Cette valeur est inférieure à DCX.

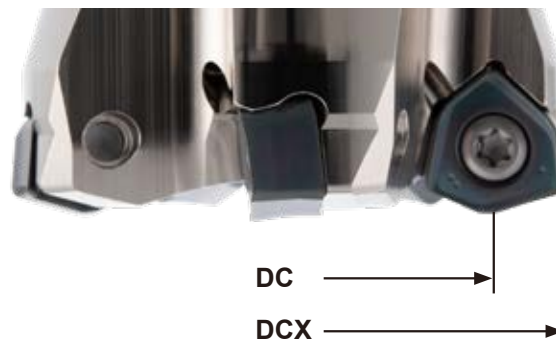

● : Article stocké.
(10 plaquettes par boîte)

K074

CONDITIONS DE COUPE RECOMMANDÉES

■ Coefficients de Correction Selon le Porte-à-Faux

Multipliez les conditions de coupe recommandées par les coefficients de correction du porte-à-faux.

Type	Diamètre de coupe max. DCX	Porte-à-faux	Coefficient de correction		
			Vitesse de coupe Vc (m/min)	Profondeur de Passe ap	Avance fz (mm/dent)
Attachement Cylindrique Fraise à Embout Fileté	25–40	< 2.5 × DCON	100%	100%	100%
		3.0 × DCON	90%	100%	90%
		4.0 × DCON	85%	90%	85%
		5.0 × DCON	80%	85%	80%
		7.5 × DCON	70%	75%	75%
Attachement Par Alésage	40–66	< 2.5 × DCX	100%	100%	100%
		3.0 × DCX	85%	100%	90%
		4.0 × DCX	80%	80%	80%
		5.0 × DCX	75%	75%	60%
		6.0 × DCX	70%	70%	40%

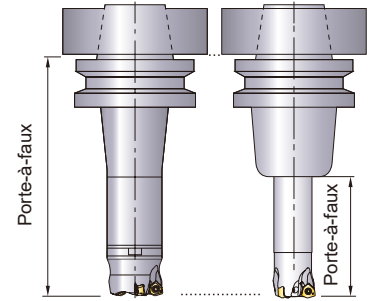

DCON=Dia. d'attachement

■ VITESSE DE COUPE (Usinage à Sec)

Matière	Propriétés	Vitesse de coupe Vc (m/min)				
		MP6130	MP6120	VP15TF	MC7020	VP30RT
P		MP6130	MP6120	VP15TF	MC7020	VP30RT
Acier doux	≤ 180HB	160 (110–200)	170 (120–220)	170 (120–220)	230 (180–280)	140 (100–180)
Acier carbone Alliage acier	180–280HB	140 (90–200)	160 (100–220)	160 (100–220)	220 (170–270)	120 (80–170)
Acier carbone Alliage acier	280–350HB	140 (90–200)	160 (100–220)	160 (100–220)	220 (170–270)	120 (80–170)
Acier outil	≤ 350HB (Recuit)	140 (90–200)	160 (100–220)	160 (100–220)	220 (170–270)	120 (80–170)
Acier pré-traité	35–45HRC	100 (60–140)	120 (80–160)	120 (80–160)	–	90 (50–130)
M		MP7130	MP7140	MC7020	VP30RT	
Acier inoxydable austénitique	≤ 200HB	160 (130–200)	150 (120–180)	220 (170–270)	150 (120–180)	
Acier inoxydable austénitique	> 200HB	140 (100–200)	130 (80–180)	190 (140–240)	130 (80–180)	
Aciers inoxydables ferritiques et martensitiques	≤ 200HB	150 (100–200)	130 (80–180)	220 (170–270)	130 (80–180)	
Acier inoxydable duplex	≤ 280HB	130 (80–180)	110 (60–160)	180 (130–230)	110 (60–160)	
Acier inoxydable à durcissement structural	< 450HB	110 (60–160)	90 (50–130)	170 (120–220)	90 (50–130)	
K		VP15TF				
Fonte grise	≤ 350MPa	180 (140–220)				
Fonte ductile	≤ 450MPa	160 (120–210)				
Fonte ductile	≤ 800MPa	130 (90–170)				
S		MP9130	MP9120	VP15TF		
Alliage titane	–	40 (30–60)	50 (30–65)	50 (30–65)		
Alliage réfractaire	–	30 (20–40)	40 (20–50)	40 (20–50)		
H		VP15TF				
Acier trempé	40–55HRC	70 (40–100)				

Remarque 1) Pour une évacuation efficace des copeaux, utilisez le soufflage d'air pendant l'usinage. Lorsque le soufflage ne permet pas une évacuation efficace des copeaux, nous recommandons d'utiliser l'arrosage.

Remarque 2) L'utilisation de l'arrosage peut réduire la durée de vie de l'outil par rapport à l'usinage à sec. Lorsque vous utilisez l'arrosage sur des applications prévues avec un usinage à sec, réduisez la vitesse de coupe de 25 %.

Remarque 3) En cas de vibrations importantes, réduisez les conditions de coupe.

Remarque 4) En coupe interrompue, réduisez les vitesses de coupe et d'avance de 20 %.

K

FRAISES À PLAQUETTES

FRAISES À PLAQUETTES

CONDITIONS DE COUPE RECOMMANDÉES

■ Profondeur de Passe / Avance par Dent

(mm)

Matière	Propriétés	Profondeur de Passe ap	Brise-copeaux	Diamètre de coupe max. DCX=25,28(Z=2)	Diamètre de coupe max. DCX=25,28(Z=3)	Diamètre de coupe max. DCX=32-	Lubrification
				Avance fz(mm/dent)	Avance fz(mm/dent)	Avance fz(mm/dent)	
K	Acier doux	≤ 0.5	M,R	1.3(0.4-2.0)	1.3(0.4-2.0)	1.5(0.5-2.0)	Sans
			L	1.2(0.4-1.6)	1.2(0.4-1.6)	1.2(0.4-1.6)	
		≤ 1.0	M,R	1.0(0.3-1.3)	0.8(0.3-1.0)	1.2(0.4-1.5)	
			L	0.8(0.3-1.2)	0.8(0.3-1.0)	0.8(0.3-1.2)	
		≤ 1.5	M,R	0.6(0.3-1.0)	—	0.8(0.4-1.2)	
	Acier carbone Alliage acier	≤ 0.5	M,R	1.3(0.4-1.7)	1.3(0.4-1.7)	1.5(0.4-2.0)	Sans
			L	1.2(0.3-1.5)	1.2(0.3-1.5)	1.2(0.3-1.5)	
		≤ 1.0	M,R	0.8(0.3-1.0)	0.7(0.3-0.9)	1.0(0.3-1.3)	
			L	0.7(0.2-1.0)	0.7(0.2-0.9)	0.7(0.2-1.0)	
		≤ 1.5	M,R	0.5(0.3-0.7)	—	0.7(0.3-1.0)	
Acier carbone Alliage acier Acier outil	≤ 0.5	M,R	1.3(0.4-1.7)	1.3(0.4-1.7)	1.5(0.4-2.0)	Sans	
		L	1.2(0.3-1.5)	1.2(0.3-1.5)	1.2(0.3-1.5)		
	≤ 1.0	M,R	0.8(0.3-1.0)	0.7(0.3-0.9)	1.0(0.3-1.3)		
		L	0.7(0.2-1.0)	0.7(0.2-0.9)	0.7(0.2-1.0)		
	≤ 1.5	M,R	0.5(0.3-0.7)	—	0.7(0.3-1.0)		
Acier pré-traité	≤ 0.5	M,R	1.0(0.3-1.3)	1.0(0.3-1.3)	1.2(0.3-1.5)	Sans	
		L	0.8(0.3-1.2)	0.8(0.3-1.2)	0.8(0.3-1.2)		
	≤ 1.0	M,R	0.6(0.2-0.8)	0.6(0.2-0.8)	0.8(0.2-1.0)		
		L	0.5(0.2-0.8)	0.5(0.2-0.8)	0.5(0.2-0.8)		
	≤ 1.5	M,R	0.5(0.3-0.7)	—	0.7(0.3-1.0)		
M	Acier inoxydable austénitique	≤ 0.5	L	0.8(0.3-1.0)	0.8(0.3-1.0)	0.8(0.3-1.0)	Sans
			M	1.0(0.4-1.2)	1.0(0.4-1.2)	1.0(0.4-1.2)	
		≤ 1.0	L	0.6(0.2-0.8)	0.6(0.2-0.8)	0.6(0.2-0.8)	
			M	0.8(0.3-1.0)	0.8(0.3-1.0)	0.8(0.3-1.0)	
	Aciers inoxydables ferritiques et martensitiques	≤ 0.5	L	0.8(0.3-1.0)	0.8(0.3-1.0)	0.8(0.3-1.0)	Sans
			M	1.0(0.4-1.2)	1.0(0.4-1.2)	1.0(0.4-1.2)	
		≤ 1.0	L	0.6(0.2-0.8)	0.6(0.2-0.8)	0.6(0.2-0.8)	
			M	0.8(0.3-1.0)	0.8(0.3-1.0)	0.8(0.3-1.0)	
	Acier inoxydable duplex	≤ 0.5	L	0.6(0.3-0.8)	0.6(0.3-0.8)	0.6(0.3-0.8)	Sans
			M	0.7(0.3-1.0)	0.7(0.3-1.0)	0.7(0.3-1.0)	
		≤ 1.0	L	0.5(0.2-0.7)	0.5(0.2-0.7)	0.5(0.2-0.7)	
			M	0.6(0.3-0.7)	0.6(0.3-0.7)	0.6(0.3-0.7)	
Acier inoxydable à durcissement structural	≤ 0.5	L	0.6(0.3-0.8)	0.6(0.3-0.8)	0.6(0.3-0.8)	Sans	
		M	0.7(0.3-1.0)	0.7(0.3-1.0)	0.7(0.3-1.0)		
	≤ 1.0	L	0.5(0.2-0.7)	0.5(0.2-0.7)	0.5(0.2-0.7)		
		M	0.6(0.3-0.7)	0.6(0.3-0.7)	0.6(0.3-0.7)		
K	Fonte grise	≤ 0.5	M,R	1.3(0.4-2.0)	1.3(0.4-2.0)	1.5(0.5-2.0)	Sans
			L	1.2(0.4-1.6)	1.2(0.4-1.6)	1.2(0.4-1.6)	
		≤ 1.0	M,R	1.0(0.3-1.3)	0.8(0.3-1.0)	1.2(0.4-1.5)	
			L	1.0(0.3-1.3)	0.8(0.3-1.0)	1.0(0.3-1.3)	
		≤ 1.5	M,R	0.6(0.3-1.0)	—	0.8(0.4-1.2)	
	Fonte ductile	≤ 0.5	M,R	1.3(0.4-1.7)	1.3(0.4-1.7)	1.5(0.4-2.0)	Sans
			L	1.0(0.3-1.3)	1.0(0.3-1.3)	1.0(0.3-1.3)	
		≤ 1.0	M,R	0.8(0.3-1.0)	0.7(0.3-0.9)	1.0(0.3-1.3)	
			L	0.8(0.2-1.0)	0.7(0.2-0.9)	0.8(0.2-1.2)	
		≤ 1.5	M,R	0.5(0.3-0.7)	—	0.7(0.3-1.0)	
Fonte ductile	≤ 0.5	M,R	1.0(0.2-1.5)	1.0(0.2-1.5)	1.3(0.3-1.7)	Sans	
		L	0.8(0.3-1.2)	0.8(0.3-1.2)	0.8(0.3-1.2)		
	≤ 1.0	M,R	0.8(0.2-1.0)	0.6(0.2-0.8)	1.0(0.3-1.2)		
		L	0.5(0.2-0.8)	0.5(0.2-0.8)	0.5(0.2-0.8)		
	≤ 1.5	M,R	0.5(0.3-0.7)	—	0.7(0.3-1.0)		
S	Alliage titane	≤ 0.5	L	0.3(0.2-0.6)	0.3(0.2-0.6)	0.3(0.2-0.6)	Avec
		≤ 1.0	L	0.3(0.2-0.4)	0.3(0.2-0.4)	0.3(0.2-0.4)	
	Alliage réfractaire	≤ 0.5	L,M,R	0.8(0.3-1.2)	0.8(0.3-1.2)	0.8(0.3-1.2)	Avec
		≤ 1.0	L,M,R	0.7(0.3-1.0)	0.7(0.3-1.0)	0.7(0.3-1.0)	
H	Acier trempé	≤ 0.5	R,M	0.6(0.3-1.0)	0.6(0.3-1.0)	0.6(0.3-1.0)	Sans
		≤ 1.0	R,M	0.5(0.3-0.8)	0.4(0.3-0.6)	0.5(0.3-0.8)	

Remarque 1) Pour une évacuation efficace des copeaux, utilisez le soufflage d'air pendant l'usinage. Lorsque le soufflage ne permet pas une évacuation efficace des copeaux, nous recommandons d'utiliser l'arrosage.

Remarque 2) En cas de vibrations importantes, réduisez les conditions de coupe.

Remarque 3) En coupe interrompue, réduisez les vitesses de coupe et d'avance de 20 %.

Remarque 4) Avec des ap de 2 mm ou plus, évitez l'usinage le long de parois et le ramping.

CAPACITÉS MAXIMALES SELON L'OPÉRATION

■ Ramping

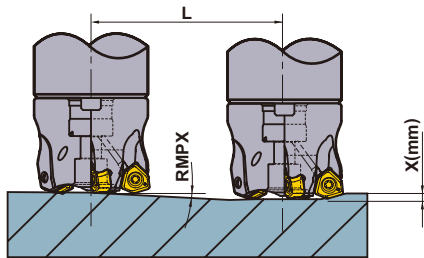

■ Interpolation Hélicoïdale

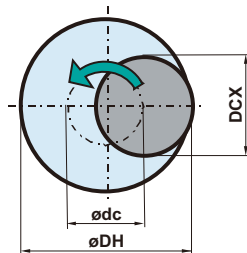

● Comment calculer l'interpolation hélicoïdale.

$$\text{ødc} = \text{øDH} - \text{DCX}$$

Diamètre d'interpolation

Diamètre de trou désiré

Diamètre de coupe max.

Porte-outil Type	DCX (mm)	DC (mm)	APMX (mm)	Ramping		Interpolation hélicoïdale (Trou borgne à fond plat)		Interpolation hélicoïdale (Trou débouchant)		AZ (mm)
				RMPX	L (mm) Distance requise pour X mm de profondeur	DH (mm)		DH (mm)	P max. (mm)	
					x = 1 (mm)	Min.	Max.	Min.		
WJX09R25	25	14.0	1.2	4.7°	12.2	38	47	34	1.2	0.8
WJX09R28	28	16.9	1.2	5.6°	10.2	44	53	38	1.2	1.2
WJX09R32	32	20.9	1.2	4.2°	13.7	52	61	46	1.2	1.2
WJX09R35	35	23.8	1.2	3.6°	15.9	58	67	52	1.2	1.2
WJX09R40	40	28.8	1.2	2.9°	19.8	68	77	61	1.2	1.2
WJX09-040	40	28.8	1.2	2.9°	19.8	68	77	61	1.2	1.2
WJX09-050	50	38.8	1.2	2.0°	28.7	88	97	81	1.2	1.2
WJX09-052	52	40.8	1.2	1.9°	30.2	92	101	85	1.2	1.2
WJX09-063	63	51.8	1.2	1.4°	41.0	114	123	107	1.2	1.2
WJX09-066	66	54.8	1.2	1.4°	41.0	120	129	113	1.2	1.2

DCX = Diamètre de coupe max.

DC = Diamètre de coupe

DH = Diamètre de trou désiré

APMX = Profondeur de coupe maximale

RMPX = Angle de rampe maximale

AZ = Profondeur de plongée maximale

Remarque 1) Pour le ramping et le perçage hélicoïdal, il est recommandé de réduire l'avance par dent.

Remarque 2) Il est possible que le ramping, le perçage hélicoïdal et le perçage produisent des copeaux longs. Restez vigilant.

<Perçage hélicoïdal>

Pour obtenir un fond plat en fraisage hélicoïdal, retirez le téton central résiduel lors d'une passe de finition.

En perçage hélicoïdal, assurez-vous que la profondeur de passe reste inférieure à la profondeur de passe maximale (APMX).

<Perçage>

Pour percer, réglez l'avance axiale par tour sur 0,2 mm maximum.

K

FRAISES À PLAQUETTES

MÉTHODE D'UTILISATION

■ Profondeur de Passe

Veillez vous référer au tableau ci-dessous pour connaître la profondeur de passe maximale de la fraise WJX09.

L'arête de coupe droite jusqu'à la profondeur de passe maximale (APMX) permet un usinage stable même à des profondeurs de passe importantes. En surfacage, il est possible de réduire l'avance pour pouvoir utiliser des profondeurs de passe supérieures à APMX (utilisation du rayon de plaquette). Vous trouverez les valeurs d'avance à la page K076.

	WJX09
Usinage à grande avance (APMX)	ap=1.2mm
Usinage à avance faible (surfaçage)	ap=1.5mm

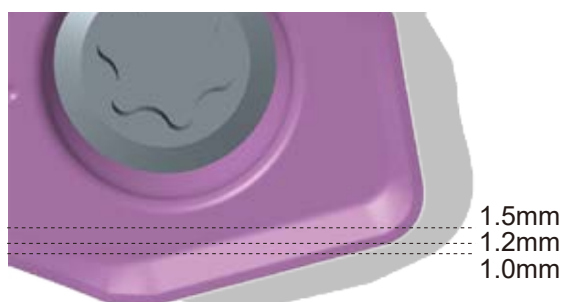

WJX09

Plaquette conventionnelle de taille 09

■ Segment résiduel

Pour la FAO, utilisez les modèles CAO (à partir des catalogues en ligne) ou utilisez une définition en tant que fraise torique en vous référant au tableau ci-dessous. Les rayons de programmation RE, les segments résiduels K1 et les quantités de surcoupe K2 sont indiqués au le tableau ci-dessous.

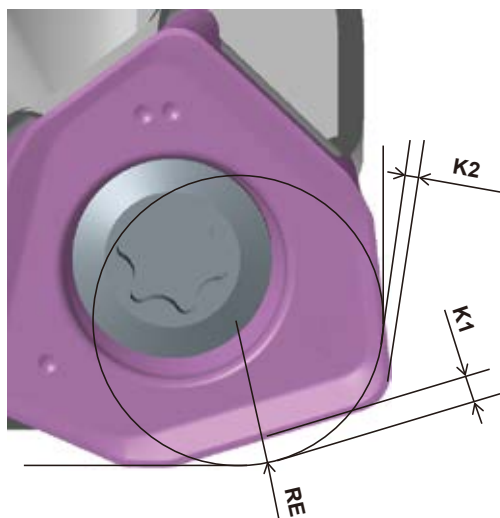

WJX09

RE (mm)	Segment résiduel K1	Quantité de surcoupe K2
R2.0 (Recommandation)	0.93	0.00
R2.3	0.86	0.00
R3.0	0.70	0.13

Profondeur de Passe ap (mm)	Segment résiduel H
0.5	0.02
1.0	0.07
1.5	-

FRAISES MULTI FONCTIONS



WJX14

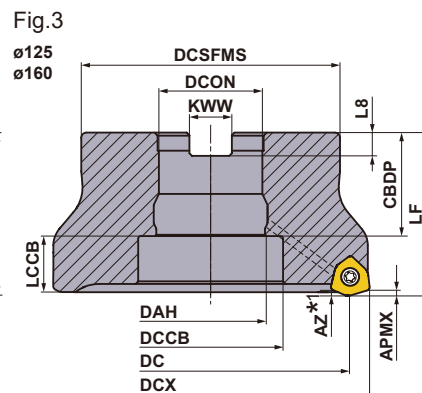
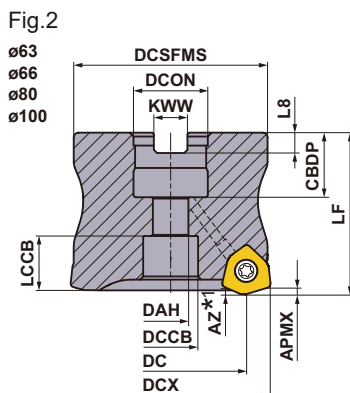
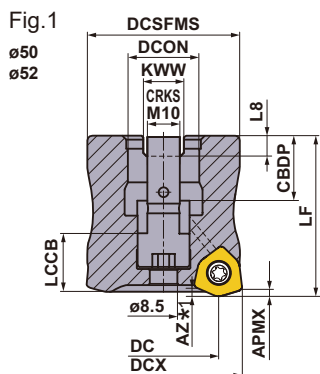

Fraise à droite uniquement.

DCON (mm)	Vis d'attache	Géométrie	
		①	②
ø22	HSC10030H	①	
ø27	HSC12035H		
ø32	HSC16040H	②	
ø40	MBA20040H MBA24045H		

■ ATTACHEMENT PAR ALÉSAGE

GAMP: -7°, -10° GAMF: -10°
Avec trou de lubrification

Remarque 1) Les fraises de diamètre DCX = 50 mm et 52 mm disposent d'une vis d'attache intégrée.
Veuillez utiliser une clé 6 pans de 7 mm pour serrer/desserrer la vis d'attache.

DCX (mm)	Référence	Stock R	Nombre de dents	Dimensions (mm)			WT *2 (kg)	APMX (mm)	RPMX (min ⁻¹)	Fig.	Type Plaque
				DC	LF	DCON					
50	WJX14-050A03AR	★	3	34.5	50	22	0.4	2	5000	1	JOMU1407
50	WJX14-050A04AR	●	4	34.5	50	22	0.4	2	5000	1	JOMU1407
52	WJX14-052A04AR	●	4	36.5	50	22	0.4	2	5000	1	JOMU1407
63	WJX14-063A04AR	●	4	47.5	50	22	0.7	2	18200	2	JOMU1407
63	WJX14-063A05AR	★	5	47.5	50	22	0.7	2	18200	2	JOMU1407
63	WJX14-063X05AR	●	5	47.5	50	27	0.6	2	18200	2	JOMU1407
66	WJX14-066X05AR	●	5	50.4	50	27	0.7	2	17700	2	JOMU1407
80	WJX14-080A05AR	●	5	64.4	50	27	1.2	2	15600	2	JOMU1407
80	WJX14-080A06AR	●	6	64.4	50	27	1.2	2	15600	2	JOMU1407
100	WJX14-100A06AR	★	6	84.4	63	32	2.5	2	13500	2	JOMU1407
100	WJX14-100A07AR	★	7	84.4	63	32	2.5	2	13500	2	JOMU1407
125	WJX14-125B07AR	★	7	109.4	63	40	3.2	2	11600	3	JOMU1407
125	WJX14-125B09AR	★	9	109.4	63	40	3.1	2	11600	3	JOMU1407
160	WJX14-160B09AR	★	9	144.4	63	40	4.9	2	9900	3	JOMU1407

*1 Cf. page K084 pour la profondeur de perçage maximale (AZ).

*2 WT : Poids du corps

Remarque 1) Les vitesses de rotation maximales autorisées (RPMX) sont définies afin d'assurer la stabilité de l'outil et des plaquettes.

Remarque 2) Les fraises de diamètre DCX = 50 mm et 52 mm disposent d'une vis d'attache intégrée, qui ne peut pas être remplacée.

Veuillez ne jamais démonter le corps de fraise.

Remarque 3) Si vous utilisez l'outil à des vitesses de rotation élevées, veuillez à l'équilibrage de l'ensemble outil-attache.

PIÈCES DÉTACHÉES

Porte-outil Type	* Vis de fixation	 Clé (Plaquette)	 Anti-grippant
WJX14	TS5R	TKY20T	MK1KS

* Couple de serrage (N • m) : TS5R = 5,0

● : Article stocké. ★ : Article standard Japon.

DIMENSIONS DE MONTAGE > K080
PIÈCES DÉTACHÉES > N001
DONNÉES TECHNIQUES > P001

FRAISES À PLAQUETTES

DIMENSIONS DE MONTAGE

DCX (mm)	Référence	Dimensions (mm)								Fig.
		DCON	CBDP	DAH	DCCB	LCCB	DCSFMS	KWW	L8	
50	WJX14-050A03AR	22	20	—	—	18.3	47	10.4	6.3	1
50	WJX14-050A04AR	22	20	—	—	18.3	47	10.4	6.3	1
52	WJX14-052A04AR	22	20	—	—	18.3	47	10.4	6.3	1
63	WJX14-063A04AR	22	20	11	17	16.7	60	10.4	6.3	2
63	WJX14-063A05AR	22	20	11	17	16.7	60	10.4	6.3	2
63	WJX14-063X05AR	27	23	13	20	15.7	60	12.4	7	2
66	WJX14-066X05AR	27	23	13	20	15.7	60	12.4	7	2
80	WJX14-080A05AR	27	23	13	20	15.7	76	12.4	7	2
80	WJX14-080A06AR	27	23	13	20	15.7	76	12.4	7	2
100	WJX14-100A06AR	32	26	17	26	25.7	96	14.4	8	2
100	WJX14-100A07AR	32	26	17	26	25.7	96	14.4	8	2
125	WJX14-125B07AR	40	40	42	56	21.7	100	16.4	9	3
125	WJX14-125B09AR	40	40	42	56	21.7	100	16.4	9	3
160	WJX14-160B09AR	40	40	42	56	21.7	100	16.4	9	3

K
FRAISES À PLAQUETTES

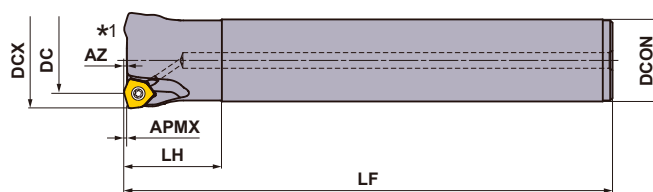

Fraise à droite uniquement.

■ ATTACHEMENT CYLINDRIQUE

Avec trou de lubrification



DCX (mm)	Référence	Stock R	Nombre de dents	Dimensions (mm)				APMX (mm)	RPMX (min ⁻¹)	Type Plaquette
				DC	LF	LH	DCON			
50	WJX14R5003SA42S	★	3	34.5	150	50	42	2	21200	JOMU1407
50	WJX14R5003SA42L	★	3	34.5	250	50	42	2	21200	JOMU1407

*1 Cf. page K084 pour la profondeur de perçage maximale (AZ).

Remarque 1) Les vitesses de rotation maximum (RPMX) préconisées assurent fiabilité de l'outil et de la plaquette.

Remarque 2) Lorsque vous utilisez un outil en usinage à grande vitesse, assurez-vous que l'outil et l'attache sont correctement équilibrés.

PIÈCES DÉTACHÉES

Porte-outil Type			
	Vis de fixation	Clé (Plaquette)	Anti-grippant
WJX14	TS5R	TKY20D	MK1KS

* Couple de serrage TS5R : 5,0 Nm

● : Article stocké. ★ : Article standard Japon.

(10 plaquettes par boîte)

PLAQUETTES

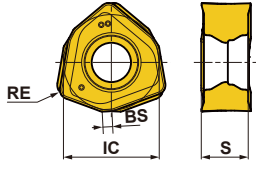
Matière	P	Acier	●	●	✦											Conditions de coupe (Guide) : ● : Coupe Stable ● : Coupe Générale ✦ : Coupe Instable Honing : E : Ronde		
	M	Acier Inoxydable	●			●	✦											
K	Fonte																	
S	Alliage réfractaire, Alliage titane							●	✦	●								
H	Matériaux durs																	
Forme	Référence	Classe	Honing	Revêtu								Dimensions (mm)				Géométrie		
				MC7020	MP6120	MP6130	MP7130	MP7140	MP9120	MP9130	VP15TF	VP30RT	IC	S	BS		RE	
	NEW JOMU140715ZZER-L	M	E	●	●	●	●	●	●	●	●	★	★	14	6.58	1.3	1.5	 Outil représenté à droite.
	JOMU140715ZZER-M	M	E	●	●	●	●	●	●	●	●	★	★	14	6.63	1.3	1.5	
	NEW JOMU140715ZZER-R	M	E	●	●	●								14	6.75	1.3	1.5	

● = **NEW**

K

FRAISES À PLAQUETTES

FRAISES À PLAQUETTES

CONDITIONS DE COUPE RECOMMANDÉES

■ Coefficients de Correction Selon le Porte-à-Faux

Multipliez les conditions de coupe recommandées par les coefficients de correction du porte-à-faux.

Type	Diamètre de coupe max. DCX	Porte-à-faux	Coefficient de correction		
			Vitesse de coupe Vc (m/min)	Profondeur de Passe ap	Avance fz (mm/dent)
Attachement Cylindrique	50	< 2.5 × DCON	100%	100%	100%
		3.0 × DCON	90%	100%	90%
		4.0 × DCON	80%	80%	90%
Attachement Par Alésage	50-80	< 2.5 × DCX	100%	100%	100%
		3.0 × DCX	85%	100%	90%
		4.0 × DCX	80%	80%	80%
		5.0 × DCX	75%	75%	60%
		6.0 × DCX	70%	70%	40%
	≥ 100	200	100%	100%	100%
		300	85%	100%	90%
		400	80%	80%	80%

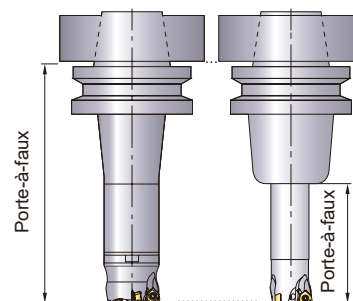

DCON=Dia. d'attachement

■ VITESSE DE COUPE (Usinage à Sec)

Matière	Propriétés	Vitesse de coupe Vc (m/min)				
		MP6130	MP6120	MC7020	VP15TF	VP30RT
P		MP6130	MP6120	MC7020	VP15TF	VP30RT
Acier doux	≤ 180HB	140 (90-180)	150 (100-200)	220 (170-270)	150 (100-200)	120 (80-160)
Acier carbone Alliage acier	180-280HB	120 (70-180)	140 (80-200)	200 (150-250)	140 (80-200)	100 (60-150)
Acier carbone Alliage acier	280-350HB	120 (70-180)	140 (80-200)	200 (150-250)	140 (80-200)	100 (60-150)
Acier outil	≤ 350HB (Recuit)	120 (70-180)	140 (80-200)	200 (150-250)	140 (80-200)	100 (60-150)
Acier pré-traité	35-45HRC	90 (50-130)	110 (70-150)	-	110 (70-150)	80 (40-120)
M		MP7130	MP7140	MC7020	VP30RT	
Acier inoxydable austénitique	≤ 200HB	160 (130-200)	150 (120-180)	220 (170-270)	150 (120-180)	
Acier inoxydable austénitique	> 200HB	140 (100-200)	130 (80-180)	190 (140-240)	130 (80-180)	
Aciers inoxydables ferritiques et martensitiques	≤ 200HB	150 (100-200)	130 (80-180)	220 (170-270)	130 (80-180)	
Acier inoxydable duplex	≤ 280HB	130 (80-180)	110 (60-160)	180 (130-230)	110 (60-160)	
Acier inoxydable à durcissement structural	< 450HB	110 (60-160)	90 (50-130)	170 (120-220)	90 (50-130)	
K		VP15TF				
Fonte grise	≤ 350MPa	160 (120-200)				
Fonte ductile	≤ 450MPa	150 (100-200)				
Fonte ductile	≤ 800MPa	120 (80-160)				
S		MP9130	MP9120	VP15TF		
Alliage titane	-	40 (30-60)	50 (30-65)	50 (30-65)		
Alliage réfractaire	-	30 (20-40)	40 (20-50)	40 (20-50)		
H		VP15TF				
Acier trempé	40-55HRC	70 (40-100)				

Remarque 1) Pour une évacuation efficace des copeaux, utilisez le soufflage d'air pendant l'usinage. Lorsque le soufflage ne permet pas une évacuation efficace des copeaux, nous recommandons d'utiliser l'arrosage.

Remarque 2) L'utilisation de l'arrosage peut réduire la durée de vie de l'outil par rapport à l'usinage à sec. Lorsque vous utilisez l'arrosage sur des applications prévues avec un usinage à sec, réduisez la vitesse de coupe de 25 %.

Remarque 3) En cas de vibrations importantes, réduisez les conditions de coupe.

Remarque 4) En coupe interrompue, réduisez les vitesses de coupe et d'avance de 20 %.

Profondeur de Passe / Avance par Dent

(mm)

Matière	Propriétés	Profondeur de Passe ap	Brise-copeaux	Diamètre de coupe max. DCX=50, 52	Diamètre de coupe max. DCX ≥ 63	Lubrification		
				Avance fz(mm/dent)	Avance fz(mm/dent)			
P	Acier doux	≤ 1.0	M,R	1.5(0.6–2.5)	1.7(0.6–2.8)	Sans		
			L	1.2(0.4–2.0)	1.2(0.4–2.0)			
		≤ 1.5	M,R	1.3(0.6–2.0)	1.5(0.6–2.5)			
			L	1.0(0.4–1.8)	1.0(0.4–1.8)			
		≤ 2.0	M,R	1.2(0.6–2.0)	1.3(0.6–2.5)			
			L	0.8(0.4–1.7)	0.8(0.4–1.7)			
		≤ 2.5	M,R	0.8(0.3–1.5)	1.0(0.3–1.6)			
		≤ 3.0	M,R	0.4(0.2–1.0)	0.5(0.2–1.2)			
		Acier carbone Alliage acier	≤ 1.0	M,R	1.5(0.5–2.0)		1.7(0.5–2.5)	Sans
				L	1.0(0.3–1.7)		1.0(0.3–1.7)	
	≤ 1.5		M,R	1.2(0.5–1.7)	1.3(0.5–2.5)			
			L	0.8(0.3–1.5)	0.8(0.3–1.5)			
	≤ 2.0		M,R	1.0(0.5–1.5)	1.2(0.5–2.0)			
			L	0.7(0.3–1.2)	0.7(0.3–1.2)			
	≤ 2.5		M,R	0.7(0.3–1.2)	0.9(0.3–1.5)			
	≤ 3.0		M,R	0.3(0.2–0.8)	0.4(0.2–1.0)			
	Acier carbone Alliage acier Acier outil		≤ 1.0	M,R	1.5(0.5–2.0)	1.7(0.5–2.5)	Sans	
				L	1.0(0.3–1.7)	1.0(0.3–1.7)		
		≤ 1.5	M,R	1.2(0.5–1.7)	1.3(0.5–2.2)			
			L	0.8(0.3–1.5)	0.8(0.3–1.5)			
≤ 2.0		M,R	1.0(0.5–1.5)	1.2(0.5–2.0)				
		L	0.7(0.3–1.2)	0.7(0.3–1.2)				
≤ 2.5		M,R	0.7(0.3–1.2)	0.9(0.3–1.5)				
≤ 3.0		M,R	0.3(0.2–0.8)	0.4(0.2–1.0)				
Acier pré-traité		≤ 1.0	M,R	1.3(0.4–1.7)	1.5(0.4–2.0)	Sans		
			L	0.7(0.3–1.2)	0.7(0.3–1.2)			
	≤ 1.5	M,R	1.0(0.4–1.5)	1.2(0.4–1.5)				
		L	0.6(0.3–1.0)	0.6(0.3–1.0)				
	≤ 2.0	M,R	0.8(0.4–1.2)	1.0(0.4–1.3)				
		L	0.5(0.3–0.8)	0.5(0.3–0.8)				
M	Acier inoxydable austénitique	≤ 1.0	L	0.8(0.3–1.2)	0.8(0.3–1.2)	Sans		
			M	1.0(0.5–1.2)	1.0(0.5–1.2)			
		≤ 1.5	L	0.8(0.3–1.0)	0.8(0.3–1.0)			
			M	1.0(0.5–1.0)	1.0(0.5–1.0)			
	Aciers inoxydables ferritiques et martensitiques	≤ 1.0	L	0.8(0.3–1.2)	0.8(0.3–1.2)	Sans		
			M	1.0(0.5–1.2)	1.0(0.5–1.2)			
		≤ 1.5	L	0.8(0.3–1.0)	0.8(0.3–1.0)			
			M	1.0(0.5–1.0)	1.0(0.5–1.0)			
	Acier inoxydable duplex	≤ 1.0	L	0.6(0.3–1.0)	0.6(0.3–1.0)	Sans		
			M	0.8(0.4–1.0)	0.8(0.4–1.0)			
		≤ 1.5	L	0.6(0.3–0.8)	0.6(0.3–0.8)			
			M	0.8(0.4–0.8)	0.8(0.4–0.8)			
Acier inoxydable à durcissement structural	≤ 1	L	0.6(0.3–1.0)	0.6(0.3–1.0)	Sans			
		M	0.8(0.4–1.0)	0.8(0.4–1.0)				
	≤ 1.5	L	0.6(0.3–0.8)	0.6(0.3–0.8)				
		M	0.8(0.4–0.8)	0.8(0.4–0.8)				
K	Fonte grise	≤ 1	M,R	1.7(0.6–2.5)	1.8(0.6–2.8)	Sans		
			L	1.3(0.4–2.0)	1.3(0.4–2.0)			
		≤ 1.5	M,R	1.5(0.6–2.0)	1.7(0.6–2.5)			
			L	1.2(0.4–1.8)	1.2(0.4–1.8)			
		≤ 2	M,R	1.3(0.6–2.0)	1.5(0.6–2.5)			
			L	1.0(0.4–1.5)	1.0(0.4–1.5)			
	≤ 2.5	M,R	0.8(0.3–1.5)	1.0(0.3–1.6)				
	≤ 3	M,R	0.4(0.2–1.0)	0.5(0.2–1.2)				
	Fonte ductile	≤ 1	M,R	1.5(0.5–2.0)	1.7(0.5–2.5)	Sans		
			L	1.2(0.3–2.0)	1.2(0.3–2.0)			
		≤ 1.5	M,R	1.3(0.5–1.8)	1.5(0.5–2.0)			
			L	1.0(0.3–1.7)	1.0(0.3–1.7)			
		≤ 2	M,R	1.2(0.5–1.8)	1.3(0.5–2.0)			
			L	0.8(0.3–1.5)	0.8(0.3–1.5)			
	≤ 2.5	M,R	0.7(0.3–1.2)	0.9(0.3–1.5)				
	≤ 3	M,R	0.3(0.2–0.8)	0.4(0.2–1.0)				
	Fonte ductile	≤ 1	M,R	1.3(0.4–1.8)	1.5(0.4–2.0)	Sans		
			L	1.0(0.3–1.7)	1.0(0.3–1.7)			
≤ 1.5		M,R	1.2(0.4–1.5)	1.3(0.4–1.8)				
		L	0.8(0.3–1.5)	0.8(0.3–1.5)				
≤ 2		M,R	1.0(0.4–1.5)	1.2(0.4–1.8)				
		L	0.7(0.3–1.2)	0.7(0.3–1.2)				
S	Alliage titane	≤ 1	L	0.3(0.2–0.6)	0.3(0.2–0.6)	Avec		
		≤ 1.5	L	0.3(0.2–0.5)	0.3(0.2–0.5)			
		≤ 2	L	0.3(0.2–0.4)	0.3(0.2–0.4)			
	Alliage réfractaire	≤ 1	L,M,R	1.0(0.3–1.3)	1.0(0.3–1.3)	Avec		
		≤ 1.5	L,M,R	0.8(0.3–1.2)	0.8(0.3–1.2)			
		≤ 2	L,M,R	0.7(0.3–1.2)	0.7(0.3–1.2)			
H	Acier trempé	≤ 1	R,M	0.8(0.3–1.2)	0.8(0.3–1.2)	Sans		
		≤ 1.5	R,M	0.6(0.3–1.0)	0.6(0.3–1.0)			
		≤ 2	R,M	0.5(0.3–0.8)	0.5(0.3–0.8)			

Remarque 1) Pour une évacuation efficace des copeaux, utilisez le soufflage d'air pendant l'usinage. Lorsque le soufflage ne permet pas une évacuation efficace des copeaux, nous recommandons d'utiliser l'arrosage.

Remarque 2) En cas de vibrations importantes, réduisez les conditions de coupe.

Remarque 3) En coupe interrompue, réduisez les vitesses de coupe et d'avance de 20 %.

Remarque 4) Avec des ap de 2 mm ou plus, évitez l'usinage le long de parois et le ramping.

K

FRAISES À PLAQUETTES

CAPACITÉS MAXIMALES SELON L'OPÉRATION

■ Ramping

■ Interpolation Hélicoïdale

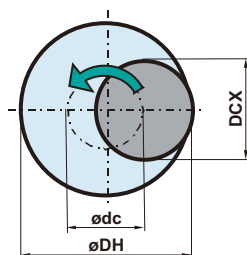
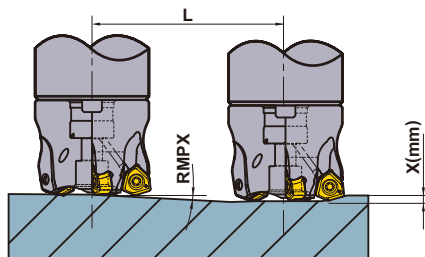

● Comment calculer l'interpolation hélicoïdale.

$$\text{ødc} = \text{øDH} - \text{DCX}$$

Diamètre d'interpolation

Diamètre de trou désiré

Diamètre de coupe max.

K

FRAISES À PLAQUETTES

(mm)

Porte-outil Type	DCX	DC	APMX	Ramping			Interpolation hélicoïdale (Trou borgne à fond plat)		Interpolation hélicoïdale (Trou débouchant)	AZ
				RMPX	L (mm) Distance requise pour X mm de profondeur		DH		DH	
					x=1	x=2	Min.	Max.	Min.	
WJX14R50	50	34.5	2	4.4°	13.0	26.0	82	97	73	2.1
WJX14-050	50	34.5	2	4.4°	13.0	26.0	82	97	73	2.1
WJX14-052	52	36.5	2	4.1°	14.0	28.0	86	101	77	2.1
WJX14-063	63	47.5	2	3.0°	19.1	38.2	108	123	99	2.1
WJX14-066	66	50.4	2	2.8°	20.5	40.9	114	129	105	2.1
WJX14-080	80	64.4	2	2.1°	27.3	54.6	142	157	133	2.1
WJX14-100	100	84.4	2	1.5°	38.2	76.4	182	197	173	2.1
WJX14-125	125	109.4	2	1.2°	47.8	95.5	232	247	223	2.1
WJX14-160	160	144.4	2	0.8°	71.7	143.3	302	317	293	2.1

DCX = Diamètre de coupe max.

DC = Diamètre de coupe

DH = Diamètre de trou désiré

APMX = Profondeur de coupe maximale

RMPX = Angle de rampe maximale

AZ = Profondeur de plongée maximale

Remarque 1) Pour le ramping et le perçage hélicoïdal, il est recommandé de réduire l'avance par dent.

Remarque 2) Il est possible que le ramping, le perçage hélicoïdal et le perçage produisent des copeaux longs. Restez vigilant.

<Perçage hélicoïdal>

Pour obtenir un fond plat en fraisage hélicoïdal, retirez le téton central résiduel lors d'une passe de finition.

En perçage hélicoïdal, assurez-vous que la profondeur de passe reste inférieure à a profondeur de passe maximale (APMX).

<Perçage>

Pour percer, réglez l'avance axiale par tour sur 0,2 mm maximum.

MÉTHODE D'UTILISATION

■ Profondeur de Passe

Veillez vous référer au tableau ci-dessous pour connaître la profondeur de passe maximale de la fraise WJX14.

L'arête de coupe droite jusqu'à la profondeur de passe maximale (APMX) permet un usinage stable même à des profondeurs de passe importantes. En surfacage, il est possible de réduire l'avance pour pouvoir utiliser des profondeurs de passe supérieures à APMX (utilisation du rayon de plaquette). Vous trouverez les valeurs d'avance à la page K083.

	WJX14
Usinage à grande avance (APMX)	ap=2.0mm
Usinage à avance faible (surfacage)	ap=3.0mm

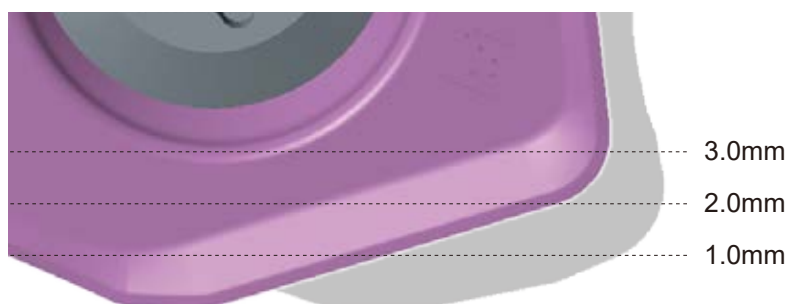

WJX14 Plaquette conventionnelle de taille 14

■ Segment résiduel

Pour la FAO, utilisez les modèles CAO (à partir des catalogues en ligne) ou utilisez une définition en tant que fraise torique en vous référant au tableau ci-dessous. Les rayons de programmation RE, les segments résiduels K1 et les quantités de surcoupe K2 sont indiqués au le tableau ci-dessous.

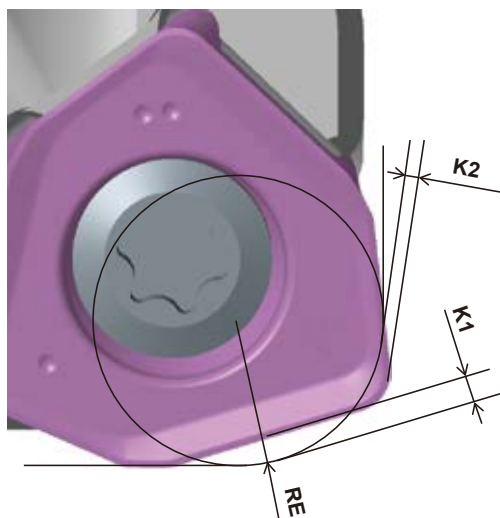

WJX14

RE (mm)	Segment résiduel K1 (mm)	Quantité de surcoupe K2 (mm)
R3.0 (Recommandation)	1.41	0.00
R3.2	1.37	0.00
R4.0	1.17	0.10
R5.0	0.92	0.39

Profondeur de Passe ap (mm)	Segment résiduel H (mm)
1.0	0.05
1.5	0.08
2.0	0.12

FRAISES À PLAQUETTES

FRAISES MULTI FONCTIONS



VPX200



K

FRAISES À PLAQUETTES



Fig.1

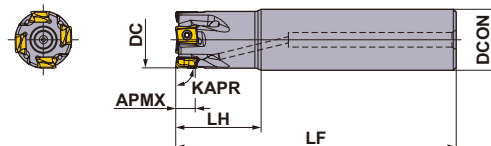
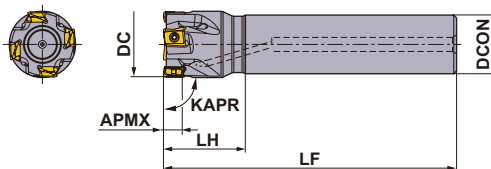

Fig.2



Outil à droite uniquement.

■ ATTACHEMENT CYLINDRIQUE

Avec trou de lubrification

DC (mm)	Référence	Stock R	Nombre de dents	Dimensions (mm)			APMX (mm)	RMPX	RPMX (min ⁻¹)	WT* (kg)	Fig.	Type Plaquette
				DCON	LF	LH						
16	VPX200R1602SA16S	●	2	16	85	25	8	1.85°	37900	0.11	1	LOGU09
18	VPX200R1802SA16S	★	2	16	85	25	8	1.56°	35300	0.12	2	LOGU09
18	VPX200R1802SA16L	●	2	16	120	25	8	1.56°	35300	0.17	2	LOGU09
20	VPX200R2002SA16S	★	2	16	100	25	8	1.35°	33200	0.14	2	LOGU09
20	VPX200R2003SA16S	●	3	16	100	25	8	1.35°	33200	0.14	2	LOGU09
20	VPX200R2002SA20S	●	2	20	100	30	8	1.35°	33200	0.21	1	LOGU09
20	VPX200R2003SA20S	●	3	20	100	30	8	1.35°	33200	0.21	1	LOGU09
20	VPX200R2002SA20L	●	2	20	150	60	8	1.35°	33200	0.32	1	LOGU09
22	VPX200R2202SA20S	★	2	20	115	30	8	1.16°	31400	0.26	2	LOGU09
22	VPX200R2203SA20S	●	3	20	115	30	8	1.16°	31400	0.25	2	LOGU09
22	VPX200R2202SA20L	★	2	20	150	30	8	1.16°	31400	0.34	2	LOGU09
25	VPX200R2503SA20S	●	3	20	115	30	8	0.97°	29000	0.26	2	LOGU09
25	VPX200R2504SA20S	●	4	20	115	30	8	0.97°	29000	0.26	2	LOGU09
25	VPX200R2503SA25S	●	3	25	115	35	8	0.97°	29000	0.39	1	LOGU09
25	VPX200R2504SA25S	●	4	25	115	35	8	0.97°	29000	0.39	1	LOGU09
25	VPX200R2503SA25L	●	3	25	170	70	8	0.97°	29000	0.57	1	LOGU09
28	VPX200R2803SA25S	★	3	25	115	35	8	0.84°	27200	0.41	2	LOGU09
28	VPX200R2804SA25S	★	4	25	115	35	8	0.84°	27200	0.41	2	LOGU09
28	VPX200R2803SA25L	★	3	25	170	35	8	0.84°	27200	0.61	2	LOGU09
30	VPX200R3003SA25S	★	3	25	125	35	8	0.77°	26000	0.46	2	LOGU09
30	VPX200R3004SA25S	★	4	25	125	35	8	0.77°	26000	0.46	2	LOGU09
32	VPX200R3203SA32S	★	3	32	125	45	8	0.71°	25100	0.70	1	LOGU09
32	VPX200R3204SA32S	●	4	32	125	45	8	0.71°	25100	0.70	1	LOGU09
32	VPX200R3205SA32S	●	5	32	125	45	8	0.71°	25100	0.70	1	LOGU09
32	VPX200R3203SA32L	●	3	32	190	90	8	0.71°	25100	1.06	1	LOGU09
35	VPX200R3503SA32L	★	3	32	190	45	8	0.63°	23800	1.14	2	LOGU09
40	VPX200R4004SA32S	★	4	32	125	45	8	0.54°	22000	0.81	2	LOGU09
40	VPX200R4006SA32S	★	6	32	125	45	8	0.54°	22000	0.80	2	LOGU09
50	VPX200R5005SA32S	★	5	32	125	45	8	0.42°	19200	0.91	2	LOGU09
50	VPX200R5007SA32S	★	7	32	125	45	8	0.42°	19200	0.91	2	LOGU09

Remarque 1) Les vitesses de rotation maximales autorisées assurent la stabilité de l'outil et des plaquettes.

Remarque 2) Si vous utilisez l'outil à vitesse de rotation élevée, veillez à bien équilibrer l'ensemble outil-attachement.

* WT : Poids de l'outil

● : Article stocké. ★ : Article standard Japon.

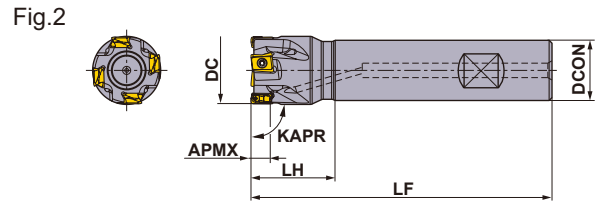
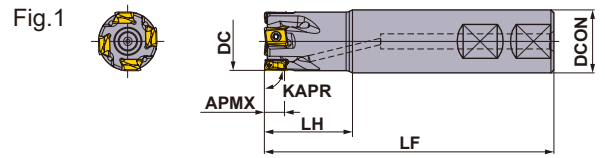

■ ATTACHEMENT WELDON

Outil à droite uniquement.

Avec trou de lubrification

DC (mm)	Référence	Stock	Nombre de dents	Dimensions (mm)			APMX (mm)	RMPX	RPMX (min ⁻¹)	WT* (kg)	Fig.	Type Plaquette
		R		DCON	LF	LH						
16	VPX200R1602WA16S	●	2	16	73	25	8	1.85°	37900	0.09	2	LOGU09
16	VPX200R1602WA16M	●	2	16	85	37	8	1.85°	37900	0.11	1	LOGU09
20	VPX200R2002WA20S	●	2	20	80	30	8	1.35°	33200	0.17	2	LOGU09
20	VPX200R2003WA20S	●	3	20	80	30	8	1.35°	33200	0.16	2	LOGU09
20	VPX200R2002WA20M	●	2	20	100	50	8	1.35°	33200	0.2	1	LOGU09
20	VPX200R2003WA20M	●	3	20	100	50	8	1.35°	33200	0.2	1	LOGU09
25	VPX200R2503WA25S	●	3	25	91	35	8	0.97°	29000	0.29	1	LOGU09
25	VPX200R2504WA25S	●	4	25	91	35	8	0.97°	29000	0.29	1	LOGU09
25	VPX200R2503WA25M	●	3	25	115	59	8	0.97°	29000	0.37	1	LOGU09
25	VPX200R2504WA25M	●	4	25	115	59	8	0.97°	29000	0.37	1	LOGU09
32	VPX200R3203WA32S	●	3	32	105	45	8	0.71°	25100	0.58	1	LOGU09
32	VPX200R3204WA32S	●	4	32	105	45	8	0.71°	25100	0.57	1	LOGU09
32	VPX200R3205WA32S	●	5	32	105	45	8	0.71°	25100	0.57	1	LOGU09
32	VPX200R3203WA32M	●	3	32	125	65	8	0.71°	25100	0.68	1	LOGU09
32	VPX200R3204WA32M	●	4	32	125	65	8	0.71°	25100	0.68	1	LOGU09
32	VPX200R3205WA32M	●	5	32	125	65	8	0.71°	25100	0.68	1	LOGU09

Remarque 1) Les vitesses de rotation maximales autorisées assurent la stabilité de l'outil et des plaquettes.

Remarque 2) Si vous utilisez l'outil à vitesse de rotation élevée, veuillez à bien équilibrer l'ensemble outil-attacheement.

* WT : Poids de l'outil

K

FRAISES À PLAQUETTES

FRAISES À PLAQUETTES

K

FRAISES À PLAQUETTES

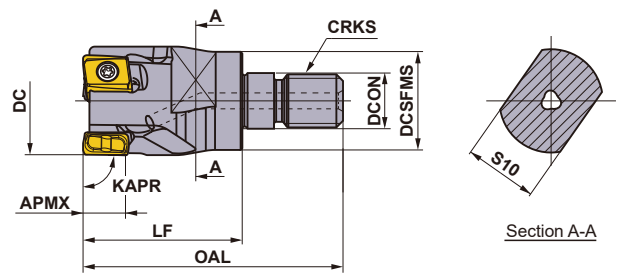
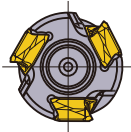

Outil à droite uniquement.

■ FRAISE À EMBOUT FILETÉ



Avec trou de lubrification

DC (mm)	Référence	Stock		Nombre de dents	Dimensions (mm)						WT* (kg)	APMX (mm)	RMPX	Type Plaquette
		R			DCON	DCSFMS	OAL	LF	S10	CRKS				
16	VPX200R1602AM0830	●		2	8.5	14.5	48	30	10	M08	0.03	8	1.85°	LOGU09
18	VPX200R1802AM0830	★		2	8.5	14.5	48	30	10	M08	0.04	8	1.56°	LOGU09
20	VPX200R2002AM1030	●		2	10.5	18.5	49	30	14	M10	0.06	8	1.35°	LOGU09
20	VPX200R2003AM1030	●		3	10.5	18.5	49	30	14	M10	0.06	8	1.35°	LOGU09
22	VPX200R2202AM1030	★		2	10.5	18.5	49	30	14	M10	0.06	8	1.16°	LOGU09
22	VPX200R2203AM1030	★		3	10.5	18.5	49	30	14	M10	0.06	8	1.16°	LOGU09
25	VPX200R2503AM1235	●		3	12.5	23.5	57	35	19	M12	0.11	8	0.97°	LOGU09
25	VPX200R2504AM1235	●		4	12.5	23.5	57	35	19	M12	0.11	8	0.97°	LOGU09
32	VPX200R3203AM1640	●		3	17.0	28.5	63	40	24	M16	0.21	8	0.71°	LOGU09
32	VPX200R3204AM1640	●		4	17.0	28.5	63	40	24	M16	0.21	8	0.71°	LOGU09
32	VPX200R3205AM1640	●		5	17.0	28.5	63	40	24	M16	0.21	8	0.71°	LOGU09
35	VPX200R3503AM1640	★		3	17.0	28.5	63	40	24	M16	0.24	8	0.63°	LOGU09
35	VPX200R3505AM1640	★		5	17.0	28.5	63	40	24	M16	0.23	8	0.63°	LOGU09
40	VPX200R4004AM1640	●		4	17.0	28.5	63	40	24	M16	0.26	8	0.54°	LOGU09
40	VPX200R4006AM1640	●		6	17.0	28.5	63	40	24	M16	0.26	8	0.54°	LOGU09

Remarque 1) Pour les attachements à visser, voir K244.

* WT : Poids de l'outil

PIÈCES DÉTACHÉES

DC (mm)	Porte-outil Type	*		
		 Vis de fixation	 Clé	 Anti-grippant
16	VPX200R16	TPS27F1	TIP07F	MK1KS
18	VPX200R18	TPS27F1	TIP07F	MK1KS
20	VPX200R20	TPS27F1	TIP07F	MK1KS
22	VPX200R22	TPS27F2	TIP07F	MK1KS
25	VPX200R25	TPS27F2	TIP07F	MK1KS
28	VPX200R28	TPS27F2	TIP07F	MK1KS
30	VPX200R30	TPS27F2	TIP07F	MK1KS
32	VPX200R32	TPS27F2	TIP07F	MK1KS
35	VPX200R35	TPS27F2	TIP07F	MK1KS
40	VPX200R40	TPS27F2	TIP07F	MK1KS
50	VPX200R50	TPS27F2	TIP07F	MK1KS

* Couple de serrage (N · m) : TPS27F1=1,0,TPS27F2=1,0

● : Article stocké. ★ : Article standard Japon.

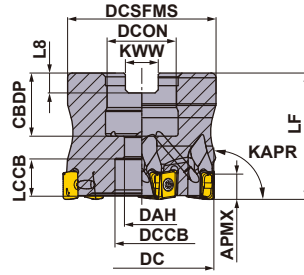

Outil à droite uniquement.

DC	Vis d'attachement	Géométrie
φ32, φ40	HSC08025H	
φ50, φ63	HSC10030H	

ATTACHEMENT PAR ALÉSAGE

KAPR: 90°
GAMP: -6° GAMF: -25°
Avec trou de lubrification

DC (mm)	Référence	Stock		Nombre de dents	Dimensions (mm)		WT* (kg)	APMX (mm)	RMPX	RPMX (min ⁻¹)	Type Plaque
		R			LF	DCON					
32	VPX200-032A03AR	●		3	35	16	0.11	8	0.71°	25100	LOGU09
32	VPX200-032A05AR	●		5	35	16	0.11	8	0.71°	25100	LOGU09
40	VPX200-040A04AR	●		4	40	16	0.23	8	0.54°	22000	LOGU09
40	VPX200-040A06AR	●		6	40	16	0.22	8	0.54°	22000	LOGU09
50	VPX200-050A05AR	●		5	40	22	0.36	8	0.42°	19200	LOGU09
50	VPX200-050A07AR	●		7	40	22	0.36	8	0.42°	19200	LOGU09
63	VPX200-063A06AR	●		6	40	22	0.66	8	0.32°	16700	LOGU09
63	VPX200-063A09AR	●		9	40	22	0.66	8	0.32°	16700	LOGU09

Remarque 1) Les vitesses de rotation maximales autorisées assurent la stabilité de l'outil et des plaquettes.

Remarque 2) Si vous utilisez l'outil à vitesse de rotation élevée, veillez à bien équilibrer l'ensemble outil-attachement.

* WT : Poids de l'outil

DIMENSIONS DE MONTAGE

DC (mm)	Référence	Dimensions (mm)							
		DCON	CBDP	DAH	DCCB	LCCB	DCSFMS	KWW	L8
32	VPX200-032A03AR	16	18	9	14	8	30	8.4	5.6
32	VPX200-032A05AR	16	18	9	14	8	30	8.4	5.6
40	VPX200-040A04AR	16	18	9	14	13	37	8.4	5.6
40	VPX200-040A06AR	16	18	9	14	13	37	8.4	5.6
50	VPX200-050A05AR	22	20	11	17	11	47	10.4	6.3
50	VPX200-050A07AR	22	20	11	17	11	47	10.4	6.3
63	VPX200-063A06AR	22	20	11	17	11	60	10.4	6.3
63	VPX200-063A09AR	22	20	11	17	11	60	10.4	6.3

PIÈCES DÉTACHÉES

Porte-outil Type	*		
VPX200	TPS27F2	TIP07F	MK1KS

* Couple de serrage TPS27F2 : 1,0 Nm



RALLONGES	> K244
PIÈCES DÉTACHÉES	> N001
DONNÉES TECHNIQUES	> P001

FRAISES À PLAQUETTES

PLAQUETTES

FRAISES À PLAQUETTES

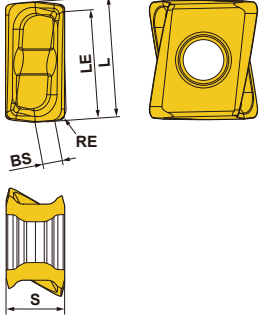
K

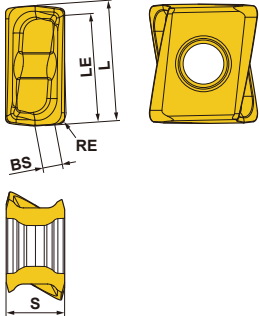
Matière	P	Acier													Conditions de coupe (Guide): ● : Coupe Stable ● : Coupe Générale ✦ : Coupe Instable					
	M	Acier Inoxydable																		
	K	Fonte																		
N	Non ferreux														Honing : E : Ronde F : Affûtée					
S	Alliage réfractaire, Alliage titane																			
H	Acier trempé																			
Forme	Référence	Classe	Honing	Revêtu						Carbure	Dimensions (mm)					Géométrie				
				MC5020	MP6120	MP6130	MP7130	MP9120	MP9130	VP15TF	TF15	L	RE	LE	S		BS			
Faible effort de coupe Brise-copeaux L NEW 	LOGU0904020PNER-L	G E	★	★	★	★	★	★	★	★			8.7	0.2	7.6	4.3	1.7	 Outil représenté à droite.		
	LOGU0904040PNER-L	G E	●	●	●	●	●	●	★				8.7	0.4	7.6	4.3	1.5			
	LOGU0904080PNER-L	G E	●	●	●	●	●	●	★				8.7	0.8	7.6	4.3	1.2			
	LOGU0904100PNER-L	G E	★	★	★	★	★	★	★				8.7	1.0	7.6	4.3	1.0			
	LOGU0904120PNER-L	G E	★	★	★	★	★	★	★				8.7	1.2	7.6	4.3	0.8			
	LOGU0904160PNER-L	G E	●	●	●	●	●	●	★				8.7	1.6	7.6	4.3	0.5			
	LOGU0904020PNFR-L	G F								●			8.7	0.2	7.6	4.3	1.7			
	LOGU0904040PNFR-L	G F								●			8.7	0.4	7.6	4.3	1.5			
	LOGU0904080PNFR-L	G F								●			8.7	0.8	7.6	4.3	1.2			
	LOGU0904100PNFR-L	G F								★			8.7	1.0	7.6	4.3	1.0			
	LOGU0904120PNFR-L	G F								★			8.7	1.2	7.6	4.3	0.8			
	LOGU0904160PNFR-L	G F								★			8.7	1.6	7.6	4.3	0.5			
	Usage général Brise-copeaux M 	LOGU0904020PNER-M	G E	★	★	★	★	★	★	★				8.7	0.2	7.6	4.3		1.7	 Outil représenté à droite.
		LOGU0904040PNER-M	G E	●	●	●	●	●	●	★				8.7	0.4	7.6	4.3		1.6	
LOGU0904080PNER-M		G E	●	●	●	●	●	●	★				8.7	0.8	7.6	4.3	1.2			
LOGU0904100PNER-M		G E	★	★	★	★	★	★	★				8.7	1.0	7.6	4.3	1.0			
LOGU0904120PNER-M		G E	★	★	★	★	★	★	★				8.7	1.2	7.6	4.3	0.9			
LOGU0904160PNER-M		G E	●	●	●	●	●	●	★				8.7	1.6	7.6	4.3	0.5			
LOGU0904020PNFR-M		G F								●			8.7	0.2	7.6	4.3	1.7			
LOGU0904040PNFR-M		G F								●			8.7	0.4	7.6	4.3	1.6			
LOGU0904080PNFR-M		G F								●			8.7	0.8	7.6	4.3	1.2			
LOGU0904100PNFR-M		G F								★			8.7	1.0	7.6	4.3	1.0			
LOGU0904120PNFR-M		G F								★			8.7	1.2	7.6	4.3	0.9			
LOGU0904160PNFR-M		G F								★			8.7	1.6	7.6	4.3	0.5			

● ★ = NEW

● : Article stocké. ★ : Article standard Japon.
(10 plaquettes par boîte)

Conditions de coupe (Guide) :

● : Coupe Stable ● : Coupe Générale ✚ : Coupe Instable

RECOMMANDATIONS BRISE-COPEAUX

■ Sélection des brise-copeaux

Matière	Propriétés	Conditions de stabilité	Brise-Copeaux		Nuance		
			1ère préconisation	2de préconisation	1ère préconisation	2de préconisation	
P	Acier doux	Dureté ≤180HB	● ●	L	M	MP6120	VP15TF
			✚	M	L	MP6130	—
	Acier carbone Alliage acier Acier outil	Dureté 180-350HB ≤350HB (recuit)	● ●	L	M	MP6120	VP15TF
			● ●	M	L	MP6120	VP15TF
			✚	M	L	MP6130	—
	Acier pré-traité	Dureté 35—45HRC	● ●	M	L	MP6120	VP15TF
✚			M	L	MP6130	—	
M	Acier inoxydable austénitique	Dureté ≤280HB	● ●	L	M	MP7130	VP15TF
			✚	M	L	MP7130	—
		Dureté >200HB	● ●	L	M	MP7130	VP15TF
			✚	M	L	MP7130	—
	Acier inoxydable duplex	Dureté ≤280HB	● ●	L	M	MP7130	VP15TF
			✚	M	L	MP7130	—
	Aciers inoxydables ferritiques et martensitiques	—	● ●	L	M	MP7130	VP15TF
			✚	M	L	MP7130	—
	Acier inoxydable à durcissement structural	Dureté <450HB	● ●	L	M	MP7130	VP15TF
			✚	M	L	MP7130	—
K	Fonte grise	Résistance à la traction ≤350MPa	● ●	M	L	MC5020	VP15TF
			✚	M	L	VP15TF	—
	Fonte ductile	Résistance à la traction ≤800MPa	● ●	M	L	MC5020	VP15TF
			✚	M	L	VP15TF	—
N	Alliage aluminium	Content Si <5%	● ●	L	M	TF15	—
			✚	M	L	TF15	—
S	Alliage titane (Ti-6Al-4V, etc.)	—	● ●	L	M	MP9120	VP15TF
			✚	M	L	MP9130	—
	Alliage titane (Ti-5Al-5V-5Mo-3Cr, etc.)	—	● ●	L	M	MP9120	VP15TF
			✚	M	L	MP9130	—
Alliage réfractaire	—	● ●	M	L	MP9120	VP15TF	
		✚	M	L	MP9130	—	
H	Acier trempé	Dureté 40—55HRC	● ● ✚	M	—	VP15TF	—

K

FRAISES À PLAQUETTES

FRAISES À PLAQUETTES

CONDITIONS DE COUPE RECOMMANDÉES

■ Usinage à sec
Vitesse de coupe

K
FRAISES À PLAQUETTES

Matière	Propriétés	Conditions de stabilité	Nuance	ae (mm)				
				≤0.25DC	0.25–0.5DC	0.5–0.75DC	DC(rainure)	
				Vc (m/min)				
P Acier doux	Dureté ≤180HB	● ●	MP6120,VP15TF	230 (180–270)	220 (170–260)	180 (140–210)	180 (140–210)	
		● ● ✱	MP6130	200 (150–240)	190 (140–230)	150 (110–180)	150 (110–180)	
	Dureté 180–350HB Alliage acier Acier outil (recuit)	● ●	MP6120,VP15TF	180 (140–210)	170 (130–200)	140 (110–160)	140 (110–160)	
		● ● ✱	MP6130	150 (110–180)	140 (100–170)	110 (80–130)	110 (80–130)	
Acier pré-traité	Dureté 35–45HRC	● ●	MP6120,VP15TF	120 (90–140)	110 (80–130)	100 (70–120)	100 (70–120)	
		● ● ✱	MP6130	100 (80–120)	90 (70–110)	80 (60–100)	80 (60–100)	
M Acier inoxydable austénitique	Dureté ≤200HB	● ● ✱	MP7130,VP15TF	180 (140–210)	170 (130–200)	140 (110–160)	140 (110–160)	
	Dureté >200HB	● ● ✱	MP7130,VP15TF	150 (110–180)	140 (100–160)	110 (80–130)	110 (80–130)	
	Acier inoxydable duplex	Dureté ≤280HB	● ● ✱	MP7130,VP15TF	140 (110–170)	130 (90–150)	100 (70–120)	100 (70–120)
	Aciers inoxydables ferritiques et martensitiques	–	● ● ✱	MP7130,VP15TF	180 (140–210)	170 (130–200)	140 (110–160)	140 (110–160)
	Acier inoxydable à durcissement structural	Dureté <450HB	● ● ✱	MP7130,VP15TF	130 (100–160)	120 (80–140)	90 (60–110)	90 (60–110)
K Fonte grise	Résistance à la traction ≤350MPa	● ●	MC5020	250 (200–300)	240 (190–290)	210 (160–260)	210 (160–260)	
		● ● ✱	VP15TF	200 (150–250)	190 (140–240)	160 (110–210)	160 (110–210)	
	Résistance à la traction ≤800MPa	● ●	MC5020	180 (150–200)	170 (140–190)	150 (120–170)	150 (120–170)	
		● ● ✱	VP15TF	130 (100–150)	120 (90–140)	100 (80–120)	100 (80–120)	
N Alliage aluminium	Content Si <5%	● ● ✱	TF15	600 (400–1000)	600 (400–1000)	600 (400–1000)	600 (400–1000)	
H Acier trempé	Dureté 40–55HRC	● ● ✱	VP15TF	90 (70–100)	85 (60–100)	70 (50–80)	70 (50–80)	

Remarque 1) Ces conditions de coupe s'appliquent aux outils courts à queue cylindrique (référence terminant en S) ou à attachement par alésage. En cas de vibration ou d'écaillage de plaquette, veuillez ajuster les conditions de coupe.

Remarque 2) Les vibrations sont plus probables dans les conditions suivantes : • Avance par dent faible ou inférieure aux préconisations.

• Porte-à-faux important (queue longue, rallonge à visser, etc.).

• Faible raideur de machine, de pièce ou de bridage.

• Dans les angles en usinage de poches.

Remarque 3) Un pas plus grossier est recommandé pour un engagement radial (ae) supérieur à 0,5x DC.

Remarque 4) Il est recommandé d'usiner sous arrosage pour obtenir de meilleurs états de surface.

(La durée de vie de l'outil est plus courte qu'en usinage à sec)

Remarque 5) Lorsque les conditions de coupe sont supérieures à celles recommandées, ou lorsque les temps copeaux sont très longs, les vis de plaquettes peuvent se fissurer. Veuillez remplacer les vis de plaquettes.

Profondeur de Passe / Avance par Dent

Matière	Propriétés	ae	Conditions de stabilité	DC (mm)					
				ø16–ø18		ø20–ø25		ø28–ø63	
				ap	fz (mm/dent)	ap	fz (mm/dent)	ap	fz (mm/dent)
P Acier doux	Dureté ≤180HB	≤0.25DC	● ● ✱	≤6	0.10–0.15	≤8	0.10–0.20	≤8	0.10–0.25
		0.25–0.5DC	● ● ✱	≤5	0.08–0.12	≤8	0.10–0.15	≤8	0.10–0.20
		0.5–0.75DC	● ● ✱	≤4	0.08–0.12	≤6	0.08–0.12	≤6	0.10–0.15
		DC(rainure)	● ● ✱	≤2	0.06–0.10	≤4	0.06–0.10	≤4	0.08–0.12
Acier carbone Alliage acier Acier outil	Dureté 180–280HB	≤0.25DC	● ● ✱	≤6	0.10–0.15	≤8	0.10–0.20	≤8	0.10–0.25
		0.25–0.5DC	● ● ✱	≤5	0.08–0.12	≤8	0.10–0.15	≤8	0.10–0.20
		0.5–0.75DC	● ● ✱	≤4	0.08–0.12	≤6	0.08–0.12	≤6	0.10–0.15
		DC(rainure)	● ● ✱	≤2	0.06–0.10	≤4	0.06–0.10	≤4	0.08–0.12
Acier carbone Alliage acier Acier outil	Dureté 280–350HB ≤350HB (recuit)	≤0.25DC	● ● ✱	≤6	0.10–0.15	≤8	0.10–0.15	≤8	0.10–0.20
		0.25–0.5DC	● ● ✱	≤5	0.08–0.12	≤8	0.08–0.12	≤8	0.10–0.15
		0.5–0.75DC	● ● ✱	≤4	0.08–0.12	≤6	0.06–0.10	≤6	0.08–0.12
		DC(rainure)	● ● ✱	≤2	0.06–0.10	≤4	0.06–0.10	≤4	0.05–0.10
Acier pré-traité	Dureté 35–45HRC	≤0.25DC	● ● ✱	≤6	0.10–0.15	≤8	0.10–0.15	≤8	0.10–0.20
		0.25–0.5DC	● ● ✱	≤5	0.08–0.12	≤8	0.08–0.12	≤8	0.10–0.15
		0.5–0.75DC	● ● ✱	≤4	0.08–0.12	≤6	0.06–0.10	≤6	0.08–0.12
		DC(rainure)	● ● ✱	≤2	0.06–0.10	≤4	0.06–0.10	≤4	0.06–0.10

Conditions de coupe (Guide) :

● : Coupe Stable ● : Coupe Générale ✖ : Coupe Instable

Profondeur de Passe / Avance par Dent

Matière	Propriétés	ae	Conditions de stabilité	DC (mm)						
				ø16-ø18		ø20-ø25		ø28-ø63		
				ap	fz (mm/dent)	ap	fz (mm/dent)	ap	fz (mm/dent)	
M	Acier inoxydable austénitique	≤0.25DC	● ●	≤6	0.10-0.15	≤8	0.10-0.20	≤8	0.10-0.20	
			● ● ✖	≤6	0.08-0.12	≤8	0.08-0.15	≤8	0.08-0.15	
		0.25-0.5DC	● ●	≤5	0.08-0.12	≤8	0.08-0.15	≤8	0.08-0.15	
			● ● ✖	≤5	0.06-0.10	≤8	0.08-0.12	≤8	0.08-0.12	
		0.5-0.75DC	● ●	≤4	0.06-0.10	≤6	0.08-0.12	≤6	0.08-0.12	
		● ● ✖	≤4	0.06-0.08	≤6	0.06-0.10	≤6	0.06-0.10		
		DC(rainure)	● ●	≤2	0.06-0.10	≤4	0.06-0.10	≤4	0.06-0.10	
		● ● ✖	≤2	0.06-0.08	≤4	0.06-0.08	≤4	0.06-0.08		
	Acier inoxydable duplex	Dureté ≤280HB	≤0.25DC	● ●	≤6	0.10-0.15	≤8	0.10-0.20	≤8	0.10-0.20
				● ● ✖	≤6	0.08-0.12	≤8	0.08-0.15	≤8	0.08-0.15
			0.25-0.5DC	● ●	≤5	0.08-0.12	≤8	0.08-0.15	≤8	0.08-0.15
				● ● ✖	≤5	0.06-0.10	≤8	0.08-0.12	≤8	0.08-0.12
	0.5-0.75DC	● ●	≤4	0.06-0.10	≤6	0.08-0.12	≤6	0.08-0.12		
	● ● ✖	≤4	0.06-0.08	≤6	0.06-0.10	≤6	0.06-0.10			
	DC(rainure)	● ●	≤2	0.06-0.10	≤4	0.06-0.10	≤4	0.06-0.10		
	● ● ✖	≤2	0.06-0.08	≤4	0.06-0.08	≤4	0.06-0.08			
Aciers inoxydables ferritiques et martensitiques	-	≤0.25DC	● ●	≤6	0.10-0.15	≤8	0.10-0.20	≤8	0.10-0.20	
			● ● ✖	≤6	0.08-0.12	≤8	0.08-0.15	≤8	0.08-0.15	
		0.25-0.5DC	● ●	≤5	0.08-0.12	≤8	0.08-0.15	≤8	0.08-0.15	
			● ● ✖	≤5	0.06-0.10	≤8	0.08-0.12	≤8	0.08-0.12	
	0.5-0.75DC	● ●	≤4	0.06-0.10	≤6	0.08-0.12	≤6	0.08-0.12		
	● ● ✖	≤4	0.06-0.08	≤6	0.06-0.10	≤6	0.06-0.10			
	DC(rainure)	● ●	≤2	0.06-0.10	≤4	0.06-0.10	≤4	0.06-0.10		
	● ● ✖	≤2	0.06-0.08	≤4	0.06-0.08	≤4	0.06-0.08			
Acier inoxydable à durcissement structural	Dureté <450HB	≤0.25DC	● ●	≤6	0.10-0.15	≤8	0.10-0.15	≤8	0.10-0.15	
			● ● ✖	≤6	0.08-0.12	≤8	0.08-0.12	≤8	0.08-0.12	
		0.25-0.5DC	● ●	≤5	0.08-0.12	≤8	0.08-0.12	≤8	0.08-0.12	
			● ● ✖	≤5	0.06-0.10	≤8	0.08-0.12	≤8	0.08-0.12	
	0.5-0.75DC	● ●	≤4	0.06-0.10	≤6	0.06-0.10	≤6	0.06-0.10		
	● ● ✖	≤4	0.06-0.08	≤6	0.06-0.08	≤6	0.06-0.08			
	DC(rainure)	● ●	≤2	0.06-0.10	≤4	0.06-0.10	≤4	0.06-0.10		
	● ● ✖	≤2	0.06-0.08	≤4	0.06-0.08	≤4	0.06-0.08			
K	Fonte grise	Résistance à la traction ≤350MPa	≤0.25DC	● ● ✖	≤6	0.10-0.15	≤8	0.10-0.20	≤8	0.10-0.25
				● ● ✖	≤6	0.08-0.12	≤8	0.08-0.15	≤8	0.10-0.20
			0.25-0.5DC	● ● ✖	≤5	0.08-0.12	≤8	0.08-0.15	≤8	0.10-0.20
				● ● ✖	≤5	0.06-0.10	≤8	0.08-0.12	≤8	0.10-0.15
		0.5-0.75DC	● ● ✖	≤4	0.08-0.12	≤6	0.08-0.12	≤6	0.10-0.15	
		● ● ✖	≤4	0.08-0.12	≤6	0.06-0.10	≤6	0.08-0.12		
		DC(rainure)	● ● ✖	≤2	0.06-0.10	≤4	0.06-0.10	≤4	0.08-0.15	
		● ● ✖	≤2	0.06-0.08	≤4	0.06-0.08	≤4	0.08-0.10		
	Fonte ductile	Résistance à la traction ≤800MPa	≤0.25DC	● ● ✖	≤6	0.10-0.15	≤8	0.10-0.20	≤8	0.10-0.20
				● ● ✖	≤6	0.08-0.12	≤8	0.10-0.15	≤8	0.10-0.15
			0.25-0.5DC	● ● ✖	≤5	0.08-0.12	≤8	0.10-0.15	≤8	0.10-0.15
				● ● ✖	≤5	0.06-0.10	≤8	0.08-0.12	≤8	0.08-0.12
	0.5-0.75DC	● ● ✖	≤4	0.08-0.12	≤6	0.08-0.12	≤6	0.08-0.12		
	● ● ✖	≤4	0.08-0.12	≤6	0.06-0.10	≤6	0.06-0.10			
	DC(rainure)	● ● ✖	≤2	0.06-0.10	≤4	0.06-0.10	≤4	0.06-0.10		
	● ● ✖	≤2	0.06-0.08	≤4	0.06-0.08	≤4	0.06-0.08			
N	Alliage aluminium	Content Si <5%	≤0.25DC	● ● ✖	≤6	0.10-0.20	≤8	0.10-0.25	≤8	0.10-0.25
				● ● ✖	≤6	0.10-0.15	≤8	0.10-0.20	≤8	0.10-0.20
			0.25-0.5DC	● ● ✖	≤5	0.10-0.15	≤8	0.10-0.20	≤8	0.10-0.20
				● ● ✖	≤5	0.08-0.12	≤8	0.10-0.15	≤8	0.10-0.15
	0.5-0.75DC	● ● ✖	≤4	0.08-0.12	≤6	0.06-0.15	≤6	0.08-0.15		
	● ● ✖	≤4	0.06-0.10	≤6	0.06-0.15	≤6	0.08-0.15			
	DC(rainure)	● ● ✖	≤2	0.06-0.10	≤4	0.06-0.15	≤4	0.08-0.15		
	● ● ✖	≤2	0.06-0.08	≤4	0.06-0.12	≤4	0.08-0.12			
H	Acier trempé	Dureté 40-55HRC	≤0.25DC	● ●	≤4	0.08-0.15	≤4	0.08-0.15	≤4	0.08-0.15
				● ● ✖	≤4	0.08-0.12	≤4	0.08-0.12	≤4	0.08-0.12
			0.25-0.5DC	● ●	≤3	0.08-0.12	≤3	0.08-0.12	≤3	0.08-0.12
				● ● ✖	≤3	0.06-0.10	≤3	0.08-0.10	≤3	0.06-0.10
	0.5-0.75DC	● ●	≤2	0.06-0.10	≤2	0.08-0.10	≤2	0.06-0.10		
	● ● ✖	≤2	0.06-0.08	≤2	0.06-0.08	≤2	0.06-0.08			
	DC(rainure)	● ●	≤1	0.06-0.10	≤1	0.06-0.10	≤1	0.06-0.10		
	● ● ✖	≤1	0.06-0.08	≤1	0.06-0.08	≤1	0.06-0.08			

Remarque 1) Ces conditions de coupe s'appliquent aux outils courts à queue cylindrique (référence terminant en S) ou à attachement par alésage. En cas de vibration ou d'écaillage de plaquette, veuillez ajuster les conditions de coupe.

Remarque 2) Les vibrations sont plus probables dans les conditions suivantes :

- Avance par dent faible ou inférieure aux préconisations.
- Porte-à-faux important (queue longue, rallonge à visser, etc.).
- Faible raideur de machine, de pièce ou de bridage.
- Dans les angles en usinage de poches.

Remarque 3) Un pas plus grossier est recommandé pour un engagement radial (ae) supérieur à 0,5x DC.

Remarque 4) Il est recommandé d'usiner sous arrosage pour obtenir de meilleurs états de surface.

(La durée de vie de l'outil est plus courte qu'en usinage à sec)

Remarque 5) Lorsque les conditions de coupe sont supérieures à celles recommandées, ou lorsque les temps copeaux sont très longs, les vis de plaquettes peuvent se fissurer. Veuillez remplacer les vis de plaquettes.

K

FRAISES À PLAQUETTES

FRAISES À PLAQUETTES

CONDITIONS DE COUPE RECOMMANDÉES

■ Coupe lubrifiée

Vitesse de coupe

Matière	Propriétés	Conditions de stabilité	Nuance	ae (mm)				
				≤0.25DC	0.25–0.5DC	0.5–0.75DC	DC(rainure)	
				Vc (m/min)				
P	Acier doux	Dureté ≤180HB	● ● ✖	MP6120 MP6130 VP15TF	140 (100–190)	130 (90–180)	100 (70–120)	100 (70–120)
	Acier carbone Alliage acier Acier outil	Dureté 180–350HB ≤350HB (recuit)	● ● ✖	MP6120 MP6130 VP15TF	120 (90–140)	110 (80–130)	100 (70–120)	100 (70–120)
	Acier pré-traité	Dureté 35–45HRC	● ● ✖	MP6120 MP6130 VP15TF	100 (80–120)	90 (70–110)	80 (60–100)	80 (60–100)
M	Acier inoxydable austénitique	Dureté ≤200HB	● ● ✖	MP7130,VP15TF	120 (100–150)	110 (90–140)	90 (70–120)	90 (70–120)
		Dureté >200HB	● ● ✖	MP7130,VP15TF	100 (80–130)	90 (70–110)	70 (50–100)	70 (50–100)
	Acier inoxydable duplex	Dureté ≤280HB	● ● ✖	MP7130,VP15TF	100 (80–130)	90 (70–120)	70 (50–100)	70 (50–100)
	Aciers inoxydables ferritiques et martensitiques	–	● ● ✖	MP7130,VP15TF	120 (100–150)	110 (90–140)	90 (70–120)	90 (70–120)
	Acier inoxydable à durcissement structural	Dureté <450HB	● ● ✖	MP7130,VP15TF	90 (70–120)	80 (60–110)	60 (40–90)	60 (40–90)
K	Fonte grise	Résistance à la traction ≤350MPa	● ● ✖	MC5020	180 (160–220)	170 (150–210)	150 (130–190)	150 (130–190)
			● ● ✖	VP15TF	130 (100–150)	120 (90–140)	100 (80–120)	100 (80–120)
	Fonte ductile	Résistance à la traction ≤800MPa	● ● ✖	MC5020 VP15TF	160 (140–180) 110 (80–140)	150 (130–170) 100 (70–130)	130 (110–150) 80 (60–120)	130 (110–150) 80 (60–120)
N	Alliage aluminium	Content Si <5%	● ● ✖	TF15	600 (400–1000)	600 (400–1000)	600 (400–1000)	600 (400–1000)
S	Alliage titane (Ti-6Al-4V, etc.)	–	● ● ✖	MP9120,VP15TF	50 (40–70)	50 (40–70)	50 (40–70)	50 (40–70)
			● ● ✖	MP9130	40 (30–60)	40 (30–60)	40 (30–60)	40 (30–60)
	Alliage titane (Ti-5Al-5V-5Mo-3Cr, etc.)	–	● ● ✖	MP9120 MP9130 VP15TF	30 (20–40)	30 (20–40)	30 (20–40)	30 (20–40)
			● ● ✖	MP9120,VP15TF	40 (30–60)	40 (30–60)	40 (30–60)	40 (30–60)
Alliage réfractaire	–	● ● ✖	MP9120,VP15TF	40 (30–60)	40 (30–60)	40 (30–60)	40 (30–60)	
		● ● ✖	MP9130	30 (20–40)	30 (20–40)	30 (20–40)	30 (20–40)	
H	Acier trempé	Dureté 40–55HRC	● ● ✖	VP15TF	90 (70–100)	85 (60–100)	70 (50–80)	70 (50–80)

Remarque 1) Ces conditions de coupe s'appliquent aux outils courts à queue cylindrique (référence terminant en S) ou à attachement par alésage. En cas de vibration ou d'écaillage de plaquette, veuillez ajuster les conditions de coupe.

Remarque 2) Les vibrations sont plus probables dans les conditions suivantes :

- Avance par dent faible ou inférieure aux préconisations.
- Porte-à-faux important (queue longue, rallonge à visser, etc.).
- Faible raideur de machine, de pièce ou de bridage.
- Dans les angles en usinage de poches.

Remarque 3) Un pas plus grossier est recommandé pour un engagement radial (ae) supérieur à 0,5x DC.

Remarque 4) Il est recommandé d'usiner sous arrosage pour obtenir de meilleurs états de surface.

(La durée de vie de l'outil est plus courte qu'en usinage à sec)

Remarque 5) Lorsque les conditions de coupe sont supérieures à celles recommandées, ou lorsque les temps copeaux sont très longs, les vis de plaquettes peuvent se fissurer. Veuillez remplacer les vis de plaquettes.

K

FRAISES À PLAQUETTES

Conditions de coupe (Guide) :

● : Coupe Stable ● : Coupe Générale ✖ : Coupe Instable

Profondeur de Passe / Avance par Dent

Matière	Propriétés	ae	Conditions de stabilité	DC (mm)						
				ø16-ø18		ø20-ø25		ø28-ø63		
				ap	fz (mm/dent)	ap	fz (mm/dent)	ap	fz (mm/dent)	
P	Acier doux	≤0.25DC	● ● ✖	≤6	0.10-0.15	≤8	0.10-0.20	≤8	0.10-0.25	
		0.25-0.5DC	● ● ✖	≤5	0.08-0.12	≤8	0.10-0.15	≤8	0.10-0.20	
		0.5-0.75DC	● ● ✖	≤4	0.08-0.12	≤6	0.08-0.12	≤6	0.10-0.15	
		DC(rainure)	● ● ✖	≤2	0.06-0.10	≤4	0.06-0.10	≤4	0.08-0.12	
	Acier carbone Alliage acier Acier outil	Dureté 180-280HB	≤0.25DC	● ● ✖	≤6	0.10-0.15	≤8	0.10-0.20	≤8	0.10-0.25
			0.25-0.5DC	● ● ✖	≤5	0.08-0.12	≤8	0.10-0.15	≤8	0.10-0.20
			0.5-0.75DC	● ● ✖	≤4	0.08-0.12	≤6	0.08-0.12	≤6	0.10-0.15
			DC(rainure)	● ● ✖	≤2	0.06-0.10	≤4	0.06-0.10	≤4	0.08-0.12
	Acier carbone Alliage acier Acier outil	Dureté 280-350HB ≤350HB (recuit)	≤0.25DC	● ● ✖	≤6	0.10-0.15	≤8	0.10-0.15	≤8	0.10-0.20
			0.25-0.5DC	● ● ✖	≤5	0.08-0.12	≤8	0.08-0.12	≤8	0.10-0.15
			0.5-0.75DC	● ● ✖	≤4	0.08-0.12	≤6	0.06-0.10	≤6	0.08-0.12
			DC(rainure)	● ● ✖	≤2	0.06-0.10	≤4	0.06-0.10	≤4	0.06-0.10
Acier pré-traité	Dureté 35-45HRC	≤0.25DC	● ● ✖	≤6	0.10-0.15	≤8	0.10-0.15	≤8	0.10-0.20	
		0.25-0.5DC	● ● ✖	≤5	0.08-0.12	≤8	0.08-0.12	≤8	0.10-0.15	
		0.5-0.75DC	● ● ✖	≤4	0.08-0.12	≤6	0.06-0.10	≤6	0.08-0.12	
		DC(rainure)	● ● ✖	≤2	0.06-0.10	≤4	0.06-0.10	≤4	0.06-0.10	
M	Acier inoxydable austénitique	≤0.25DC	● ● ✖	≤6	0.10-0.15	≤8	0.10-0.20	≤8	0.10-0.20	
		0.25-0.5DC	● ● ✖	≤5	0.08-0.12	≤8	0.08-0.15	≤8	0.08-0.15	
		0.5-0.75DC	● ● ✖	≤4	0.06-0.10	≤6	0.08-0.12	≤6	0.08-0.12	
		DC(rainure)	● ● ✖	≤2	0.06-0.10	≤4	0.06-0.10	≤4	0.06-0.10	
	Acier inoxydable duplex	Dureté ≤280HB	≤0.25DC	● ● ✖	≤6	0.10-0.15	≤8	0.10-0.20	≤8	0.10-0.20
			0.25-0.5DC	● ● ✖	≤5	0.08-0.12	≤8	0.08-0.15	≤8	0.08-0.12
			0.5-0.75DC	● ● ✖	≤4	0.06-0.10	≤6	0.08-0.12	≤6	0.08-0.12
			DC(rainure)	● ● ✖	≤2	0.06-0.10	≤4	0.06-0.10	≤4	0.06-0.10
	Aciers inoxydables ferritiques et martensitiques	-	≤0.25DC	● ● ✖	≤6	0.10-0.15	≤8	0.10-0.20	≤8	0.10-0.20
			0.25-0.5DC	● ● ✖	≤5	0.08-0.12	≤8	0.08-0.15	≤8	0.08-0.15
			0.5-0.75DC	● ● ✖	≤4	0.06-0.10	≤6	0.08-0.12	≤6	0.08-0.12
			DC(rainure)	● ● ✖	≤2	0.06-0.10	≤4	0.06-0.10	≤4	0.05-0.10
Acier inoxydable à durcissement structural	Dureté <450HB	≤0.25DC	● ● ✖	≤6	0.10-0.15	≤8	0.10-0.15	≤8	0.10-0.15	
		0.25-0.5DC	● ● ✖	≤5	0.08-0.12	≤8	0.08-0.12	≤8	0.08-0.12	
		0.5-0.75DC	● ● ✖	≤4	0.06-0.10	≤6	0.06-0.10	≤6	0.05-0.10	
		DC(rainure)	● ● ✖	≤2	0.06-0.10	≤4	0.06-0.10	≤4	0.05-0.10	
K	Fonte grise	≤0.25DC	● ● ✖	≤6	0.10-0.15	≤8	0.10-0.20	≤8	0.10-0.25	
		0.25-0.5DC	● ● ✖	≤5	0.08-0.12	≤8	0.08-0.15	≤8	0.10-0.20	
		0.5-0.75DC	● ● ✖	≤4	0.08-0.12	≤6	0.06-0.10	≤6	0.10-0.15	
		DC(rainure)	● ● ✖	≤2	0.06-0.10	≤4	0.06-0.10	≤4	0.08-0.15	
	Fonte ductile	Résistance à la traction ≤800MPa	≤0.25DC	● ● ✖	≤6	0.10-0.15	≤8	0.10-0.20	≤8	0.10-0.20
			0.25-0.5DC	● ● ✖	≤5	0.08-0.12	≤8	0.10-0.15	≤8	0.10-0.15
			0.5-0.75DC	● ● ✖	≤4	0.08-0.12	≤6	0.08-0.12	≤6	0.08-0.12
			DC(rainure)	● ● ✖	≤2	0.06-0.10	≤4	0.06-0.10	≤4	0.06-0.10

Remarque 1) Ces conditions de coupe s'appliquent aux outils courts à queue cylindrique (référence terminant en S) ou à attachement par alésage. En cas de vibration ou d'écaillage de plaquette, veuillez ajuster les conditions de coupe.

Remarque 2) Les vibrations sont plus probables dans les conditions suivantes :

- Avance par dent faible ou inférieure aux préconisations.
- Porte-à-faux important (queue longue, rallonge à visser, etc.).
- Faible raideur de machine, de pièce ou de bridage.
- Dans les angles en usinage de poches.

Remarque 3) Un pas plus grossier est recommandé pour un engagement radial (ae) supérieur à 0,5x DC.

Remarque 4) Il est recommandé d'usiner sous arrosage pour obtenir de meilleurs états de surface.

(La durée de vie de l'outil est plus courte qu'en usinage à sec)

Remarque 5) Lorsque les conditions de coupe sont supérieures à celles recommandées, ou lorsque les temps copeaux sont très longs, les vis de plaquettes peuvent se fissurer. Veuillez remplacer les vis de plaquettes.

K

FRAISES À PLAQUETTES

CONDITIONS DE COUPE RECOMMANDÉES

■ Coupe lubrifiée

Profondeur de Passe / Avance par Dent

Matière	Propriétés	ae	Conditions de stabilité	DC (mm)					
				ø16-ø18		ø20-ø25		ø28-ø63	
				ap	fz (mm/dent)	ap	fz (mm/dent)	ap	fz (mm/dent)
N Alliage aluminium	Content Si < 5%	≤0.25DC	● ● ✦	≤6	0.10-0.20	≤8	0.10-0.25	≤8	0.10-0.25
		0.25-0.5DC	● ● ✦	≤6	0.10-0.15	≤8	0.10-0.20	≤8	0.10-0.20
		0.5-0.75DC	● ● ✦	≤5	0.10-0.15	≤8	0.10-0.20	≤8	0.10-0.20
		0.5-0.75DC	● ● ✦	≤5	0.08-0.12	≤8	0.10-0.15	≤8	0.10-0.15
		DC(rainure)	● ● ✦	≤4	0.08-0.12	≤6	0.06-0.15	≤6	0.08-0.15
DC(rainure)	● ● ✦	≤4	0.06-0.10	≤6	0.06-0.15	≤6	0.08-0.15		
DC(rainure)	● ● ✦	≤2	0.06-0.10	≤4	0.06-0.15	≤4	0.08-0.15		
DC(rainure)	● ● ✦	≤2	0.06-0.08	≤4	0.06-0.12	≤4	0.08-0.12		
S Alliage titane (Ti-6Al-4V, etc.)	-	≤0.25DC	● ● ✦	≤6	0.08-0.15	≤8	0.08-0.15	≤8	0.08-0.15
		0.25-0.5DC	● ● ✦	≤5	0.08-0.12	≤8	0.08-0.12	≤8	0.08-0.12
		0.5-0.75DC	● ● ✦	≤4	0.06-0.10	≤6	0.06-0.10	≤6	0.06-0.10
		DC(rainure)	● ● ✦	≤2	0.06-0.10	≤4	0.06-0.10	≤4	0.06-0.10
Alliage titane (Ti-5Al-5V-5Mo-3Cr, etc.)	-	≤0.25DC	● ● ✦	≤6	0.08-0.12	≤8	0.08-0.12	≤8	0.08-0.12
		0.25-0.5DC	● ● ✦	≤5	0.08-0.12	≤8	0.08-0.12	≤8	0.08-0.12
		0.5-0.75DC	● ● ✦	≤4	0.06-0.10	≤6	0.06-0.10	≤6	0.06-0.10
		DC(rainure)	● ● ✦	≤2	0.06-0.10	≤4	0.06-0.10	≤4	0.06-0.10
Alliage réfractaire	-	≤0.25DC	● ● ✦	≤6	0.08-0.12	≤8	0.08-0.12	≤8	0.08-0.12
		0.25-0.5DC	● ● ✦	≤5	0.08-0.12	≤8	0.08-0.12	≤8	0.08-0.12
		0.5-0.75DC	● ● ✦	≤4	0.06-0.10	≤6	0.06-0.10	≤6	0.06-0.10
		DC(rainure)	● ● ✦	≤2	0.06-0.10	≤4	0.06-0.10	≤4	0.06-0.10
H Acier trempé	Dureté 40-55HRC	≤0.25DC	● ● ✦	≤4	0.08-0.15	≤4	0.08-0.15	≤4	0.08-0.15
		0.25-0.5DC	● ● ✦	≤4	0.08-0.12	≤4	0.08-0.12	≤4	0.08-0.12
		0.25-0.5DC	● ● ✦	≤3	0.08-0.12	≤3	0.08-0.12	≤3	0.08-0.12
		0.5-0.75DC	● ● ✦	≤3	0.06-0.10	≤3	0.06-0.10	≤3	0.06-0.10
		0.5-0.75DC	● ● ✦	≤2	0.06-0.10	≤2	0.06-0.10	≤2	0.06-0.10
DC(rainure)	● ● ✦	≤2	0.06-0.10	≤2	0.06-0.10	≤2	0.06-0.10		
DC(rainure)	● ● ✦	≤1	0.06-0.10	≤1	0.06-0.10	≤1	0.06-0.10		
DC(rainure)	● ● ✦	≤1	0.06-0.10	≤1	0.06-0.10	≤1	0.06-0.10		

Remarque 1) Ces conditions de coupe s'appliquent aux outils courts à queue cylindrique (référence terminant en S) ou à attachement par alésage. En cas de vibration ou d'écaillage de plaquette, veuillez ajuster les conditions de coupe.

Remarque 2) Les vibrations sont plus probables dans les conditions suivantes :

- Avance par dent faible ou inférieure aux préconisations.
- Porte-à-faux important (queue longue, rallonge à visser, etc.).
- Faible raideur de machine, de pièce ou de bridage.
- Dans les angles en usinage de poches.

Remarque 3) Un pas plus grossier est recommandé pour un engagement radial (ae) supérieur à 0,5x DC.

Remarque 4) Il est recommandé d'usiner sous arrosage pour obtenir de meilleurs états de surface.

(La durée de vie de l'outil est plus courte qu'en usinage à sec)

Remarque 5) Lorsque les conditions de coupe sont supérieures à celles recommandées, ou lorsque les temps copeaux sont très longs, les vis de plaquettes peuvent se fissurer. Veuillez remplacer les vis de plaquettes.

■ Ramping / Interpolation Hélicoïdale

● Ramping

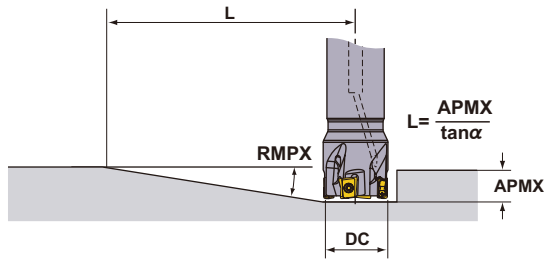

● Interpolation Hélicoïdale

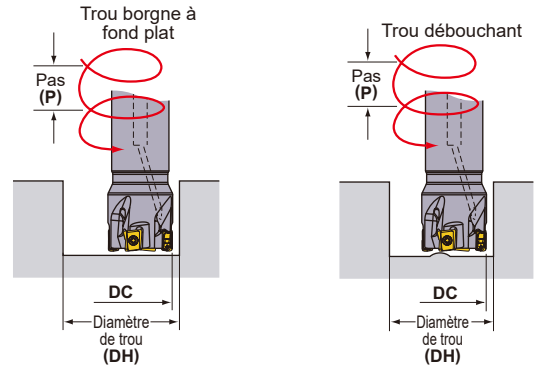

Se référer au tableau ci-dessous pour les conditions de coupe. Pour l'avance par dent et la vitesse de coupe, se référer aux conditions de coupe pour rainurage.

DC (mm)	RE (mm)	Ramping		Interpolation Hélicoïdale (Trou borgne à fond plat)				Interpolation Hélicoïdale (Trou débouchant)	
		RMPX	L (mm) *	DH max. (mm)	P max. (mm)	DH min. (mm)	P max. (mm)	DH min. (mm)	P max. (mm)
16	0.2	1.85°	248	31.0	1.5	27.5	1.2	24.2	0.8
	0.4	1.85°	248	30.6	1.5	27.5	1.2	24.2	0.8
	0.8	1.85°	248	29.8	1.4	27.5	1.2	24.2	0.8
	1.0	1.85°	248	29.4	1.4	27.5	1.2	24.2	0.8
	1.2	1.85°	248	29.0	1.3	27.5	1.2	24.2	0.8
	1.6	1.85°	248	28.2	1.2	27.5	1.2	24.2	0.8
18	0.2	1.56°	294	35.0	1.5	31.5	1.2	28.1	0.9
	0.4	1.56°	294	34.6	1.4	31.5	1.2	28.1	0.9
	0.8	1.56°	294	33.8	1.4	31.5	1.2	28.1	0.9
	1.0	1.56°	294	33.4	1.3	31.5	1.2	28.1	0.9
	1.2	1.56°	294	33.0	1.3	31.5	1.2	28.1	0.9
	1.6	1.56°	294	32.2	1.2	31.5	1.2	28.1	0.9
20	0.2	1.35°	340	39.0	1.4	35.5	1.1	32.0	0.9
	0.4	1.35°	340	38.6	1.4	35.5	1.1	32.0	0.9
	0.8	1.35°	340	37.8	1.3	35.5	1.1	32.0	0.9
	1.0	1.35°	340	37.4	1.3	35.5	1.1	32.0	0.9
	1.2	1.35°	340	37.0	1.3	35.5	1.1	32.0	0.9
	1.6	1.35°	340	36.2	1.2	35.5	1.1	32.0	0.9
22	0.2	1.16°	396	43.0	1.3	39.5	1.1	36.0	0.9
	0.4	1.16°	396	42.6	1.3	39.5	1.1	36.0	0.9
	0.8	1.16°	396	41.8	1.3	39.5	1.1	36.0	0.9
	1.0	1.16°	396	41.4	1.2	39.5	1.1	36.0	0.9
	1.2	1.16°	396	41.0	1.2	39.5	1.1	36.0	0.9
	1.6	1.16°	396	40.2	1.2	39.5	1.1	36.0	0.9
25	0.2	0.97°	473	49.0	1.3	45.5	1.1	42.0	0.9
	0.4	0.97°	473	48.6	1.3	45.5	1.1	42.0	0.9
	0.8	0.97°	473	47.8	1.2	45.5	1.1	42.0	0.9
	1.0	0.97°	473	47.4	1.2	45.5	1.1	42.0	0.9
	1.2	0.97°	473	47.0	1.2	45.5	1.1	42.0	0.9
	1.6	0.97°	473	46.2	1.1	45.5	1.1	42.0	0.9
28	0.2	0.84°	546	55.0	1.2	51.5	1.1	48.0	0.9
	0.4	0.84°	546	54.6	1.2	51.5	1.1	48.0	0.9
	0.8	0.84°	546	53.8	1.2	51.5	1.1	48.0	0.9
	1.0	0.84°	546	53.4	1.2	51.5	1.1	48.0	0.9
	1.2	0.84°	546	53.0	1.2	51.5	1.1	48.0	0.9
	1.6	0.84°	546	52.2	1.1	51.5	1.1	48.0	0.9
30	0.2	0.77°	596	59.0	1.2	55.5	1.1	52.0	0.9
	0.4	0.77°	596	58.6	1.2	55.5	1.1	52.0	0.9
	0.8	0.77°	596	57.8	1.2	55.5	1.1	52.0	0.9
	1.0	0.77°	596	57.4	1.2	55.5	1.1	52.0	0.9
	1.2	0.77°	596	57.0	1.1	55.5	1.1	52.0	0.9
	1.6	0.77°	596	56.2	1.1	55.5	1.1	52.0	0.9
32	0.2	0.71°	646	62.8	1.2	59.4	1.1	56.0	0.9
	0.4	0.71°	646	62.4	1.2	59.4	1.1	56.0	0.9
	0.8	0.71°	646	61.6	1.2	59.4	1.1	56.0	0.9
	1.0	0.71°	646	61.2	1.1	59.4	1.1	56.0	0.9
	1.2	0.71°	646	60.8	1.1	59.4	1.1	56.0	0.9
	1.6	0.71°	646	60.0	1.1	59.4	1.1	56.0	0.9

Remarque 1) L'usinage en ramping peut créer des copeaux longs dans les matières ductiles.

* Distance jusqu'à ce qu'une profondeur de coupe maximale de 8 mm soit atteinte à l'angle de ramping maximal $L = 8/\tan \alpha$.

FRAISES À PLAQUETTES

■ Ramping / Interpolation Hélicoïdale

● Ramping

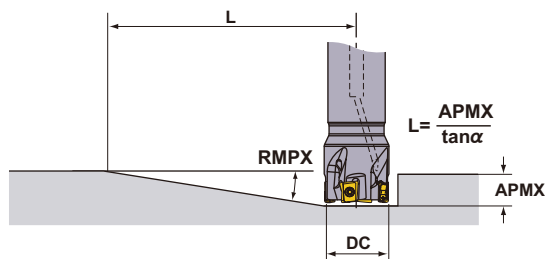

● Interpolation Hélicoïdale

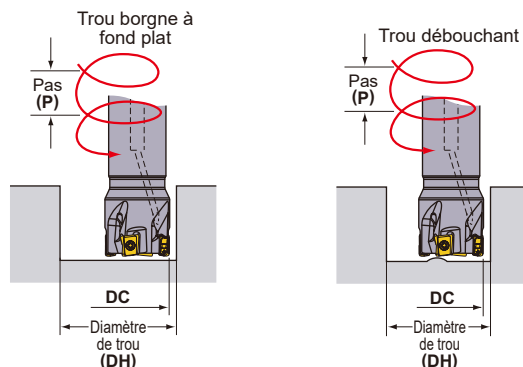

Se référer au tableau ci-dessous pour les conditions de coupe. Pour l'avance par dent et la vitesse de coupe, se référer aux conditions de coupe pour rainurage.

DC (mm)	RE (mm)	Ramping		Interpolation Hélicoïdale (Trou borgne à fond plat)				Interpolation Hélicoïdale (Trou débouchant)	
		RMPX	L (mm) *	DH max. (mm)	P max. (mm)	DH min. (mm)	P max. (mm)	DH min. (mm)	P max. (mm)
35	0.2	0.63°	728	69.0	1.2	65.5	1.1	62.0	0.9
	0.4	0.63°	728	68.6	1.2	65.5	1.1	62.0	0.9
	0.8	0.63°	728	67.8	1.1	65.5	1.1	62.0	0.9
	1.0	0.63°	728	67.4	1.1	65.5	1.1	62.0	0.9
	1.2	0.63°	728	67.0	1.1	65.5	1.1	62.0	0.9
	1.6	0.63°	728	66.2	1.1	65.5	1.1	62.0	0.9
40	0.2	0.54°	849	78.8	1.2	75.4	1.0	72.0	0.9
	0.4	0.54°	849	78.4	1.1	75.4	1.0	72.0	0.9
	0.8	0.54°	849	77.6	1.1	75.4	1.0	72.0	0.9
	1.0	0.54°	849	77.2	1.1	75.4	1.0	72.0	0.9
	1.2	0.54°	849	76.8	1.1	75.4	1.0	72.0	0.9
	1.6	0.54°	849	76.0	1.1	75.4	1.0	72.0	0.9
50	0.2	0.42°	1092	98.8	1.1	95.4	1.0	92.0	1.0
	0.4	0.42°	1092	98.4	1.1	95.4	1.0	92.0	1.0
	0.8	0.42°	1092	97.6	1.1	95.4	1.0	92.0	1.0
	1.0	0.42°	1092	97.2	1.1	95.4	1.0	92.0	1.0
	1.2	0.42°	1092	96.8	1.1	95.4	1.0	92.0	1.0
	1.6	0.42°	1092	96.0	1.1	95.4	1.0	92.0	1.0
63	0.2	0.32°	1433	124.8	1.1	121.4	1.0	118.0	1.0
	0.4	0.32°	1433	124.4	1.1	121.4	1.0	118.0	1.0
	0.8	0.32°	1433	123.6	1.1	121.4	1.0	118.0	1.0
	1.0	0.32°	1433	123.2	1.1	121.4	1.0	118.0	1.0
	1.2	0.32°	1433	122.8	1.1	121.4	1.0	118.0	1.0
	1.6	0.32°	1433	122.0	1.0	121.4	1.0	118.0	1.0

Remarque 1) L'usinage en ramping peut créer des copeaux longs dans les matières ductiles.

* Distance jusqu'à ce qu'une profondeur de coupe maximale de 8 mm soit atteinte à l'angle de ramping maximal $L = 8 / \tan \alpha$.

K

FRAISES À PLAQUETTES

■ Tréflage et Perçage

Voir les tableaux de droite pour les engagements et profondeurs de perçage. Pour l'avance par dent et la vitesse de coupe, veuillez utiliser les conditions de coupe pour le rainurage.

● Tréflage

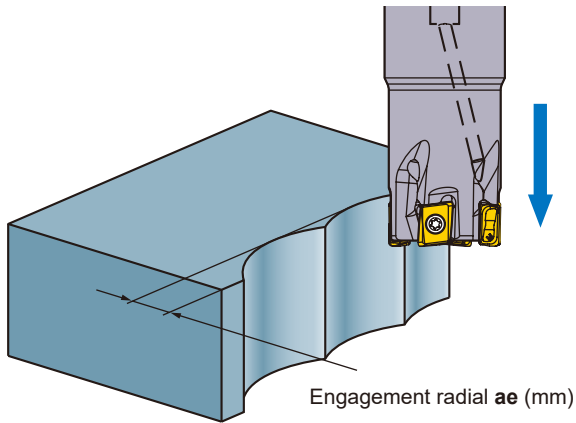

DC (mm)	ae max. (mm)
16	3.9
18	3.9
20	3.9
22	4.0
25	4.0
28	4.0
30	4.0
32	4.0
35	4.0
40	4.0
50	4.0
63	4.0

Remarque 1) Un cycle de déburrage n'est pas nécessaire.

● Perçage

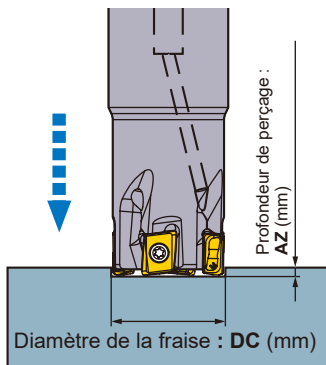

DC (mm)	AZ max. (mm)
16	0.3
18	0.3
20	0.3
22	0.3
25	0.3
28	0.3
30	0.3
32	0.3
35	0.3
40	0.3
50	0.3
63	0.3

Remarque 1) Attention aux projections de copeaux.

Remarque 2) Évacuez les copeaux à l'aide d'air comprimé (ou de liquide d'arrosage lors de l'usinage d'un alliage d'aluminium).

FRAISES À PLAQUETTES

FRAISES MULTI FONCTIONS



VPX300



K

FRAISES À PLAQUETTES

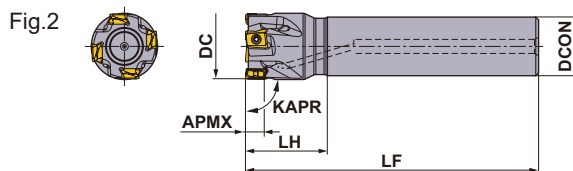
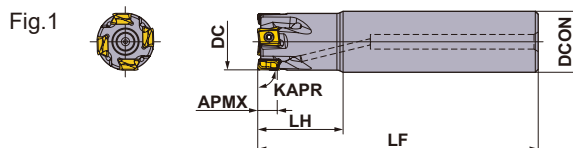

Outil à droite uniquement.

■ ATTACHEMENT CYLINDRIQUE

Avec trou de lubrification

DC (mm)	Référence	Stock R	Nombre de dents	Dimensions (mm)			APMX (mm)	RMPX	RPMX (min ⁻¹)	WT* (kg)	Fig.	Type Plaquette
				DCON	LF	LH						
25	VPX300R2502SA25S	●	2	25	115	35	11	2.13°	24100	0.38	1	LOGU12
25	VPX300R2502SA25L	●	2	25	170	70	11	2.13°	24100	0.56	1	LOGU12
28	VPX300R2802SA25S	★	2	25	115	35	11	1.77°	22500	0.40	2	LOGU12
28	VPX300R2802SA25L	★	2	25	170	35	11	1.77°	22500	0.60	2	LOGU12
30	VPX300R3002SA25S	★	2	25	125	35	11	1.61°	21500	0.45	2	LOGU12
30	VPX300R3003SA25S	★	3	25	125	35	11	1.61°	21500	0.44	2	LOGU12
32	VPX300R3202SA32S	●	2	32	125	45	11	1.47°	20600	0.69	1	LOGU12
32	VPX300R3203SA32S	●	3	32	125	45	11	1.47°	20600	0.68	1	LOGU12
32	VPX300R3203SA32L	●	3	32	190	90	11	1.47°	20600	1.04	1	LOGU12
35	VPX300R3503SA32L	★	3	32	190	45	11	1.28°	19500	1.10	2	LOGU12
40	VPX300R4003SA32S	●	3	32	125	45	11	1.06°	17900	0.76	2	LOGU12
40	VPX300R4004SA32S	●	4	32	125	45	11	1.06°	17900	0.76	2	LOGU12
50	VPX300R5004SA32S	★	4	32	125	45	11	0.79°	15500	0.89	2	LOGU12
50	VPX300R5006SA32S	★	6	32	125	45	11	0.79°	15500	0.88	2	LOGU12

Remarque 1) Les vitesses de rotation maximales autorisées assurent la stabilité de l'outil et des plaquettes.

Remarque 2) Si vous utilisez l'outil à vitesse de rotation élevée, veuillez à bien équilibrer l'ensemble outil-attacheement.

* WT : Poids de l'outil

● : Article stocké. ★ : Article standard Japon.



Fig.1

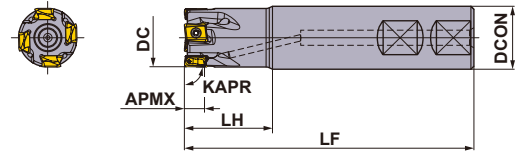

Outil à droite uniquement.

■ ATTACHEMENT WELDON

Avec trou de lubrification

DC (mm)	Référence	Stock	Nombre de dents	Dimensions (mm)			APMX (mm)	RMPX	RPMX (min ⁻¹)	WT* (kg)	Fig.	Type Plaquette
		R		DCON	LF	LH						
25	VPX300R2502WA25S	●	2	25	91	35	11	2.13°	24100	0.29	1	LOGU12
32	VPX300R3202WA32S	●	2	32	105	45	11	1.47°	20600	0.56	1	LOGU12
32	VPX300R3203WA32S	●	3	32	105	45	11	1.47°	20600	0.55	1	LOGU12

Remarque 1) Les vitesses de rotation maximales autorisées assurent la stabilité de l'outil et des plaquettes.

Remarque 2) Si vous utilisez l'outil à vitesse de rotation élevée, veuillez à bien équilibrer l'ensemble outil-attache.

* WT : Poids de l'outil

FRAISES À PLAQUETTES

K

FRAISES À PLAQUETTES

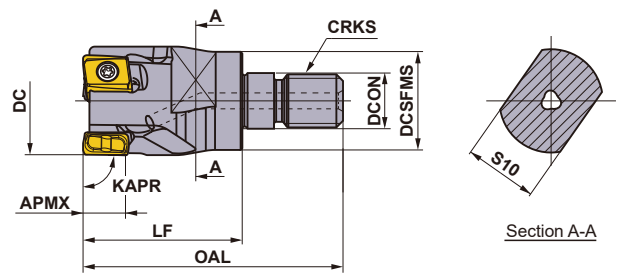
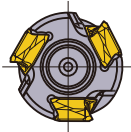

Outil à droite uniquement.

■ FRAISE À EMBOUT FILETÉ



Avec trou de lubrification

DC (mm)	Référence	Stock R	Nombre de dents	Dimensions (mm)						WT* (kg)	APMX (mm)	RMPX	Type Plaquette
				DCON	DCSFMS	OAL	LF	S10	CRKS				
25	VPX300R2502AM1235	●	2	12.5	23.5	57	35	19	M12	0.10	11	2.13°	LOGU12
28	VPX300R2802AM1235	★	2	12.5	23.5	57	35	19	M12	0.12	11	1.77°	LOGU12
32	VPX300R3202AM1640	●	2	17.0	28.5	63	40	24	M16	0.20	11	1.47°	LOGU12
32	VPX300R3203AM1640	●	3	17.0	28.5	63	40	24	M16	0.19	11	1.47°	LOGU12
35	VPX300R3502AM1640	★	2	17.0	28.5	63	40	24	M16	0.22	11	1.28°	LOGU12
35	VPX300R3503AM1640	★	3	17.0	28.5	63	40	24	M16	0.22	11	1.28°	LOGU12
40	VPX300R4003AM1640	●	3	17.0	28.5	63	40	24	M16	0.26	11	1.06°	LOGU12
40	VPX300R4004AM1640	●	4	17.0	28.5	63	40	24	M16	0.26	11	1.06°	LOGU12

Remarque 1) Pour les attachements à visser, voir K244.

* WT : Poids de l'outil

PIÈCES DÉTACHÉES

DC (mm)	Porte-outil Type	*		
		 Vis de fixation	 Clé	 Anti-grippant
25	VPX300R25	TPS40F1	TIP15W	MK1KS
28	VPX300R28	TPS40F1	TIP15W	MK1KS
30	VPX300R30	TPS40F1	TIP15W	MK1KS
32	VPX300R32	TPS40F1	TIP15W	MK1KS
35	VPX300R35	TPS40F1	TIP15W	MK1KS
40	VPX300R40	TPS40F1	TIP15W	MK1KS
50	VPX300R50	TPS40F1	TIP15W	MK1KS

* Couple de serrage TPS40F1 : 3,0 Nm

● : Article stocké. ★ : Article standard Japon.

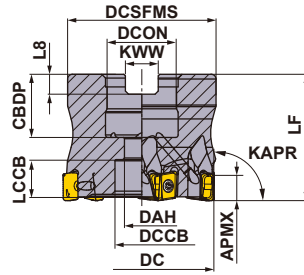

DC (mm)	Vis d'attachement	Géométrie
φ40	HSC08025H	
φ50, φ63	HSC10030H	
φ80	HSC12035H	

ATTACHEMENT PAR ALÉSAGE

Outil à droite uniquement.

KAPR: 90°

GAMP: -6° GAMF: -22.5°

Avec trou de lubrification

DC (mm)	Référence	Stock	Nombre de dents	Dimensions (mm)		WT*	APMX (mm)	RMPX	RPMX (min ⁻¹)	Type Plaquette
		R		LF	DCON					
40	VPX300-040A03AR	●	3	40	16	0.21	11	1.06°	17900	LOGU12
40	VPX300-040A04AR	●	4	40	16	0.21	11	1.06°	17900	LOGU12
50	VPX300-050A04AR	●	4	40	22	0.34	11	0.79°	15500	LOGU12
50	VPX300-050A06AR	●	6	40	22	0.33	11	0.79°	15500	LOGU12
63	VPX300-063A06AR	●	6	40	22	0.61	11	0.60°	13400	LOGU12
63	VPX300-063A08AR	●	8	40	22	0.62	11	0.60°	13400	LOGU12
80	VPX300-080A07AR	●	7	50	27	0.99	11	0.45°	11500	LOGU12
80	VPX300-080A10AR	●	10	50	27	0.99	11	0.45°	11500	LOGU12

Remarque 1) Les vitesses de rotation maximales autorisées assurent la stabilité de l'outil et des plaquettes.

Remarque 2) Si vous utilisez l'outil à vitesse de rotation élevée, veillez à bien équilibrer l'ensemble outil-attachement.

* WT : Poids de l'outil

DIMENSIONS DE MONTAGE

DC (mm)	Référence	Dimensions (mm)							
		DCON	CBDP	DAH	DCCB	LCCB	DCSFMS	KWW	L8
40	VPX300-040A03AR	16	18	9	14	12.4	37	8.4	5.6
40	VPX300-040A04AR	16	18	9	14	12.4	37	8.4	5.6
50	VPX300-050A04AR	22	20	11	17	10.4	47	10.4	6.3
50	VPX300-050A06AR	22	20	11	17	10.4	47	10.4	6.3
63	VPX300-063A06AR	22	20	11	17	10.4	60	10.4	6.3
63	VPX300-063A08AR	22	20	11	17	10.4	60	10.4	6.3
80	VPX300-080A07AR	27	23	13	20	13.4	56	12.4	7.0
80	VPX300-080A10AR	27	23	13	20	13.4	56	12.4	7.0

PIÈCES DÉTACHÉES

Porte-outil Type	*		
	Vis de fixation	Clé	Anti-grippant
VPX300	TPS40F1	TIP15W	MK1KS

* Couple de serrage TPS40F1 : 3,0 Nm

RALLONGES	> K244
PIÈCES DÉTACHÉES	> N001
DONNÉES TECHNIQUES	> P001

FRAISES À PLAQUETTES

PLAQUETTES

FRAISES À PLAQUETTES

K

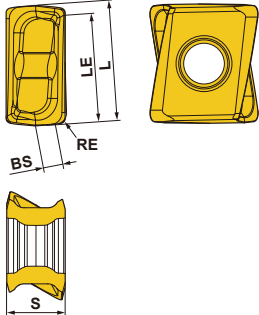
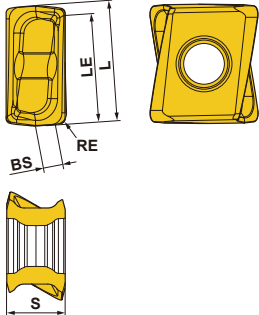
Matière	P	Acier							Conditions de coupe (Guide): ● : Coupe Stable ● : Coupe Générale ✦ : Coupe Instable								
	M	Acier Inoxydable								Honing : E : Ronde F : Affûtée							
	K	Fonte															
N	Non ferreux																
S	Alliage réfractaire, Alliage titane																
H	Acier trempé																
Forme	Référence	Classe	Honing	Revêtu						Carbure	Dimensions (mm)					Géométrie	
				MC5020	MP6120	MP6130	MP7130	MP9120	MP9130	VP15TF	TF15	L	RE	LE	S		BS
Faible effort de coupe Brise-copeaux L	LOGU1207020PNER-L	G E	★	★	★	★	★	★	★	★		12.4	0.2	11.3	7.0	3.0	 Outil représenté à droite.
	LOGU1207040PNER-L	G E	●	●	●	●	●	●	★		12.4	0.4	11.3	7.0	2.8		
	LOGU1207080PNER-L	G E	●	●	●	●	●	●	★		12.4	0.8	11.3	7.0	2.6		
	LOGU1207100PNER-L	G E	★	★	★	★	★	★	★		12.4	1.0	11.3	7.0	2.5		
	LOGU1207120PNER-L	G E	●	●	●	●	●	●	★		12.4	1.2	11.3	7.0	2.4		
	LOGU1207160PNER-L	G E	●	●	●	●	●	●	★		12.4	1.6	11.3	7.0	1.8		
	LOGU1207200PNER-L	G E	●	●	●	●	●	●	★		12.4	2.0	11.3	7.0	1.4		
	LOGU1207240PNER-L	G E	●	●	●	●	●	●	★		12.4	2.4	11.3	7.0	1.2		
	LOGU1207300PNER-L	G E	★	★	★	★	★	★	★		12.4	3.0	11.3	7.0	0.6		
	LOGU1207320PNER-L	G E	●	●	●	●	●	●	★		12.4	3.2	11.3	7.0	0.4		
	LOGU1207020PNFR-L	G F							★		12.4	0.2	11.3	7.0	3.0		
	LOGU1207040PNFR-L	G F							●		12.4	0.4	11.3	7.0	2.8		
	LOGU1207080PNFR-L	G F							●		12.4	0.8	11.3	7.0	2.6		
	LOGU1207100PNFR-L	G F							★		12.4	1.0	11.3	7.0	2.5		
	LOGU1207120PNFR-L	G F							●		12.4	1.2	11.3	7.0	2.4		
	LOGU1207160PNFR-L	G F							●		12.4	1.6	11.3	7.0	1.8		
	LOGU1207200PNFR-L	G F							●		12.4	2.0	11.3	7.0	1.4		
	LOGU1207240PNFR-L	G F							●		12.4	2.4	11.3	7.0	1.2		
LOGU1207300PNFR-L	G F							★		12.4	3.0	11.3	7.0	0.6			
LOGU1207320PNFR-L	G F							●		12.4	3.2	11.3	7.0	0.4			
Usage général Brise-copeaux M	LOGU1207020PNER-M	G E	★	★	★	★	★	★	★		12.4	0.2	11.3	7.0	3.0	 Outil représenté à droite.	
	LOGU1207040PNER-M	G E	●	●	●	●	●	●	★		12.4	0.4	11.3	7.0	2.8		
	LOGU1207080PNER-M	G E	●	●	●	●	●	●	★		12.4	0.8	11.3	7.0	2.4		
	LOGU1207100PNER-M	G E	★	★	★	★	★	★	★		12.4	1.0	11.3	7.0	2.3		
	LOGU1207120PNER-M	G E	●	●	●	●	●	●	★		12.4	1.2	11.3	7.0	2.1		
	LOGU1207160PNER-M	G E	●	●	●	●	●	●	★		12.4	1.6	11.3	7.0	1.7		
	LOGU1207200PNER-M	G E	●	●	●	●	●	●	★		12.4	2.0	11.3	7.0	1.4		
	LOGU1207240PNER-M	G E	●	●	●	●	●	●	★		12.4	2.4	11.3	7.0	1.0		
	LOGU1207300PNER-M	G E	★	★	★	★	★	★	★		12.4	3.0	11.3	7.0	0.5		
	LOGU1207320PNER-M	G E	●	●	●	●	●	●	★		12.4	3.2	11.3	7.0	0.3		
	LOGU1207020PNFR-M	G F							★		12.4	0.2	11.3	7.0	3.0		
	LOGU1207040PNFR-M	G F							●		12.4	0.4	11.3	7.0	2.8		
	LOGU1207080PNFR-M	G F							●		12.4	0.8	11.3	7.0	2.4		
	LOGU1207100PNFR-M	G F							★		12.4	1.0	11.3	7.0	2.3		
	LOGU1207120PNFR-M	G F							●		12.4	1.2	11.3	7.0	2.1		
	LOGU1207160PNFR-M	G F							●		12.4	1.6	11.3	7.0	1.7		
	LOGU1207200PNFR-M	G F							●		12.4	2.0	11.3	7.0	1.4		
	LOGU1207240PNFR-M	G F							●		12.4	2.4	11.3	7.0	1.0		
LOGU1207300PNFR-M	G F							★		12.4	3.0	11.3	7.0	0.5			
LOGU1207320PNFR-M	G F							●		12.4	3.2	11.3	7.0	0.3			

● ★ = **NEW**

● : Article stocké. ★ : Article standard Japon.
(10 plaquettes par boîte)

Conditions de coupe (Guide) :

● : Coupe Stable ● : Coupe Générale ✚ : Coupe Instable

RECOMMANDATIONS BRISE-COPEAUX

■ Sélection des brise-copeaux

Matière	Propriétés	Conditions de stabilité	Brise-Copeaux		Nuance		
			1ère préconisation	2de préconisation	1ère préconisation	2de préconisation	
P	Acier doux	Dureté ≤180HB	● ●	L	M	MP6120	VP15TF
			✚	M	L	MP6130	—
	Acier carbone Alliage acier Acier outil	Dureté 180-350HB ≤350HB (recuit)	● ●	L	M	MP6120	VP15TF
			● ●	M	L	MP6120	VP15TF
			✚	M	L	MP6130	—
	Acier pré-traité	Dureté 35–45HRC	● ●	M	L	MP6120	VP15TF
✚			M	L	MP6130	—	
M	Acier inoxydable austénitique	Dureté ≤280HB	● ●	L	M	MP7130	VP15TF
			✚	M	L	MP7130	—
		Dureté >200HB	● ●	L	M	MP7130	VP15TF
			✚	M	L	MP7130	—
	Acier inoxydable duplex	Dureté ≤280HB	● ●	L	M	MP7130	VP15TF
			✚	M	L	MP7130	—
	Aciers inoxydables ferritiques et martensitiques	—	● ●	L	M	MP7130	VP15TF
			✚	M	L	MP7130	—
	Acier inoxydable à durcissement structural	Dureté <450HB	● ●	L	M	MP7130	VP15TF
			✚	M	L	MP7130	—
K	Fonte grise	Résistance à la traction ≤350MPa	● ●	M	L	MC5020	VP15TF
			✚	M	L	VP15TF	—
	Fonte ductile	Résistance à la traction ≤800MPa	● ●	M	L	MC5020	VP15TF
			✚	M	L	VP15TF	—
N	Alliage aluminium	Content Si <5%	● ●	L	M	TF15	—
			✚	M	L	TF15	—
S	Alliage titane (Ti-6Al-4V, etc.)	—	● ●	L	M	MP9120	VP15TF
			✚	M	L	MP9130	—
	Alliage titane (Ti-5Al-5V-5Mo-3Cr, etc.)	—	● ●	L	M	MP9120	VP15TF
			✚	M	L	MP9130	—
	Alliage réfractaire	—	● ●	M	L	MP9120	VP15TF
			✚	M	L	MP9130	—
H	Acier trempé	Dureté 40–55HRC	● ● ✚	M	—	VP15TF	—

K

FRAISES À PLAQUETTES

FRAISES À PLAQUETTES

CONDITIONS DE COUPE RECOMMANDÉES

■ Usinage à sec

Vitesse de coupe

FRAISES À PLAQUETTES

Matière	Propriétés	Conditions de stabilité	Plaquette Nuance	ae (mm)				
				≤0.25DC	0.25–0.5DC	0.5–0.75DC	DC(rainure)	
				Vc (m/min)				
P Acier doux	Dureté ≤180HB	● ● ✖	MP6120, VP15TF	230 (180–270)	220 (170–260)	180 (140–210)	180 (140–210)	
			MP6130	200 (150–240)	190 (170–260)	150 (110–180)	150 (110–180)	
	Acier carbone Alliage acier Acier outil	Dureté 180–350HB ≤350HB (recuit)	● ● ✖	MP6120, VP15TF	180 (140–210)	170 (130–200)	140 (110–160)	140 (110–180)
				MP6130	150 (110–180)	140 (100–170)	110 (80–130)	110 (80–130)
Acier pré-traité	Dureté 35–45HRC	● ● ✖	MP6120, VP15TF	120 (90–140)	110 (80–130)	100 (70–120)	100 (70–120)	
			MP6130	100 (80–120)	90 (70–110)	80 (60–100)	80 (60–100)	
M Acier inoxydable austénitique	Dureté ≤200HB	● ● ✖	MP7130, VP15TF	180 (140–210)	170 (130–200)	140 (110–160)	140 (110–160)	
	Dureté >200HB	● ● ✖	MP7130, VP15TF	150 (110–180)	140 (100–160)	110 (80–130)	110 (80–130)	
	Acier inoxydable duplex	Dureté ≤280HB	● ● ✖	MP7130, VP15TF	140 (110–170)	130 (90–150)	100 (70–120)	100 (70–120)
	Aciers inoxydables ferritiques et martensitiques	–	● ● ✖	MP7130, VP15TF	180 (140–210)	170 (130–200)	140 (110–160)	140 (110–160)
	Acier inoxydable à durcissement structural	Dureté <450HB	● ● ✖	MP7130, VP15TF	130 (100–160)	120 (80–140)	90 (60–110)	90 (60–110)
K Fonte grise	Résistance à la traction ≤350MPa	● ● ✖	MC5020	250 (200–300)	240 (190–290)	210 (160–260)	210 (160–260)	
			VP15TF	200 (150–250)	190 (140–240)	160 (110–210)	160 (110–210)	
	Fonte ductile	Résistance à la traction ≤800MPa	● ● ✖	MC5020	180 (150–200)	170 (140–190)	150 (120–170)	150 (120–170)
				VP15TF	130 (100–150)	120 (90–140)	100 (80–120)	100 (80–120)
N Alliage aluminium	Content Si <5%	● ● ✖	TF15	600 (400–1000)	600 (400–1000)	600 (400–1000)	600 (400–1000)	
H Acier trempé	Dureté 40–55HRC	● ● ✖	VP15TF	90 (70–100)	85 (60–100)	70 (50–80)	70 (50–80)	

Remarque 1) Ces conditions de coupe s'appliquent aux outils courts à queue cylindrique (référence terminant en S) ou à attachement par alésage. En cas de vibration ou d'écaillage de plaquette, veuillez ajuster les conditions de coupe.

Remarque 2) Les vibrations sont plus probables dans les conditions suivantes :

- Avance par dent faible ou inférieure aux préconisations.
- Porte-à-faux important (queue longue, rallonge à visser, etc.).
- Faible raideur de machine, de pièce ou de bridage.
- Dans les angles en usinage de poches.

Remarque 3) Un pas plus grossier est recommandé pour un engagement radial (ae) supérieur à 0,5x DC.

Remarque 4) Il est recommandé d'usiner sous arrosage pour obtenir de meilleurs états de surface.

(La durée de vie de l'outil est plus courte qu'en usinage à sec)

Remarque 5) Lorsque les conditions de coupe sont supérieures à celles recommandées, ou lorsque les temps copeaux sont très longs, les vis de plaquettes peuvent se fissurer. Veuillez remplacer les vis de plaquettes.

Profondeur de Passe / Avance par Dent

Matière	Propriétés	ae (mm)	Conditions de stabilité	DC (mm)			
				ø25		ø28–ø80	
				ap (mm)	fz (mm/dent)	ap (mm)	fz (mm/dent)
P Acier doux	Dureté ≤180HB	≤0.25DC	● ● ✖	≤11	0.10 – 0.20	≤11	0.10 – 0.30
		0.25–0.5DC	● ● ✖	≤11	0.10 – 0.15	≤11	0.10 – 0.25
		0.5–0.75DC	● ● ✖	≤8	0.08 – 0.12	≤8	0.10 – 0.20
		DC(rainure)	● ● ✖	≤5	0.06 – 0.10	≤5	0.08 – 0.15
Acier carbone Alliage acier Acier outil	Dureté 180–280HB	≤0.25DC	● ● ✖	≤11	0.10 – 0.20	≤11	0.10 – 0.30
		0.25–0.5DC	● ● ✖	≤11	0.10 – 0.15	≤11	0.10 – 0.25
		0.5–0.75DC	● ● ✖	≤8	0.08 – 0.12	≤8	0.10 – 0.20
		DC(rainure)	● ● ✖	≤5	0.06 – 0.10	≤5	0.08 – 0.15
Acier carbone Alliage acier Acier outil	Dureté 280–350HB ≤350HB (recuit)	≤0.25DC	● ● ✖	≤11	0.10 – 0.15	≤11	0.10 – 0.25
		0.25–0.5DC	● ● ✖	≤11	0.08 – 0.12	≤11	0.10 – 0.20
		0.5–0.75DC	● ● ✖	≤8	0.06 – 0.10	≤8	0.10 – 0.15
		DC(rainure)	● ● ✖	≤5	0.06 – 0.10	≤5	0.08 – 0.12
Acier pré-traité	Dureté 35–45HRC	≤0.25DC	● ● ✖	≤11	0.10 – 0.15	≤11	0.10 – 0.25
		0.25–0.5DC	● ● ✖	≤11	0.08 – 0.12	≤11	0.10 – 0.20
		0.5–0.75DC	● ● ✖	≤8	0.06 – 0.10	≤8	0.10 – 0.15
		DC(rainure)	● ● ✖	≤5	0.06 – 0.10	≤5	0.08 – 0.12

Conditions de coupe (Guide) :

● : Coupe Stable ● : Coupe Générale ✖ : Coupe Instable

Profondeur de Passe / Avance par Dent

Matière	Propriétés	ae (mm)	Conditions de stabilité	DC (mm)				
				ø25		ø28-ø80		
				ap (mm)	fz (mm/dent)	ap (mm)	fz (mm/dent)	
M	Acier inoxydable austénitique	≤0.25DC	● ● ✖	≤11	0.10-0.20	≤11	0.10-0.20	
			● ● ✖	≤11	0.08-0.15	≤11	0.08-0.15	
		0.25-0.5DC	● ● ✖	≤11	0.08-0.15	≤11	0.08-0.15	
			● ● ✖	≤11	0.08-0.12	≤11	0.08-0.12	
	0.5-0.75DC	● ● ✖	≤8	0.08-0.12	≤8	0.08-0.12		
		● ● ✖	≤8	0.06-0.10	≤8	0.06-0.10		
	DC(rainure)	● ● ✖	≤5	0.06-0.10	≤5	0.06-0.10		
		● ● ✖	≤5	0.06-0.08	≤5	0.06-0.08		
	Acier inoxydable duplex	Dureté ≤280HB	≤0.25DC	● ● ✖	≤11	0.10-0.20	≤11	0.10-0.20
				● ● ✖	≤11	0.08-0.15	≤11	0.08-0.15
		0.25-0.5DC	● ● ✖	≤11	0.08-0.15	≤11	0.08-0.15	
			● ● ✖	≤11	0.08-0.12	≤11	0.08-0.12	
	0.5-0.75DC	● ● ✖	≤8	0.08-0.12	≤8	0.08-0.12		
		● ● ✖	≤8	0.06-0.10	≤8	0.06-0.10		
	DC(rainure)	● ● ✖	≤5	0.06-0.10	≤5	0.06-0.10		
		● ● ✖	≤5	0.06-0.08	≤5	0.06-0.08		
Aciers inoxydables ferritiques et martensitiques	-	≤0.25DC	● ● ✖	≤11	0.10-0.20	≤11	0.10-0.20	
			● ● ✖	≤11	0.08-0.15	≤11	0.08-0.15	
		0.25-0.5DC	● ● ✖	≤11	0.08-0.15	≤11	0.08-0.15	
			● ● ✖	≤11	0.08-0.12	≤11	0.08-0.12	
0.5-0.75DC	● ● ✖	≤8	0.08-0.12	≤8	0.08-0.12			
	● ● ✖	≤8	0.06-0.10	≤8	0.06-0.10			
DC(rainure)	● ● ✖	≤5	0.06-0.10	≤5	0.06-0.10			
	● ● ✖	≤5	0.06-0.08	≤5	0.06-0.08			
Acier inoxydable à durcissement structural	Dureté <450HB	≤0.25DC	● ● ✖	≤11	0.10-0.15	≤11	0.10-0.15	
			● ● ✖	≤11	0.08-0.12	≤11	0.08-0.12	
		0.25-0.5DC	● ● ✖	≤11	0.08-0.12	≤11	0.08-0.12	
			● ● ✖	≤11	0.08-0.12	≤11	0.06-0.10	
0.5-0.75DC	● ● ✖	≤8	0.06-0.10	≤8	0.06-0.10			
	● ● ✖	≤8	0.06-0.08	≤8	0.06-0.08			
DC(rainure)	● ● ✖	≤5	0.06-0.10	≤5	0.06-0.10			
	● ● ✖	≤5	0.06-0.08	≤5	0.06-0.08			
K	Fonte grise	Résistance à la traction ≤350MPa	● ● ✖	≤11	0.10-0.20	≤11	0.10-0.30	
			● ● ✖	≤11	0.08-0.15	≤11	0.10-0.25	
		0.25-0.5DC	● ● ✖	≤11	0.08-0.15	≤11	0.10-0.25	
			● ● ✖	≤11	0.08-0.12	≤11	0.10-0.20	
	0.5-0.75DC	● ● ✖	≤8	0.08-0.12	≤8	0.10-0.20		
		● ● ✖	≤8	0.06-0.10	≤8	0.08-0.15		
	DC(rainure)	● ● ✖	≤5	0.06-0.10	≤5	0.08-0.15		
		● ● ✖	≤5	0.06-0.08	≤5	0.08-0.12		
Fonte ductile	Résistance à la traction ≤800MPa	≤0.25DC	● ● ✖	≤11	0.10-0.20	≤11	0.10-0.25	
			● ● ✖	≤11	0.10-0.15	≤11	0.10-0.20	
		0.25-0.5DC	● ● ✖	≤11	0.10-0.15	≤11	0.10-0.20	
			● ● ✖	≤11	0.08-0.12	≤11	0.10-0.15	
0.5-0.75DC	● ● ✖	≤8	0.08-0.12	≤8	0.10-0.15			
	● ● ✖	≤8	0.08-0.12	≤8	0.08-0.12			
DC(rainure)	● ● ✖	≤5	0.06-0.10	≤5	0.08-0.12			
	● ● ✖	≤5	0.06-0.08	≤5	0.06-0.10			
N	Alliage aluminium	Content Si <5%	● ● ✖	≤11	0.10-0.25	≤11	0.10-0.25	
			● ● ✖	≤11	0.10-0.20	≤11	0.10-0.20	
			● ● ✖	≤11	0.10-0.20	≤11	0.10-0.20	
			● ● ✖	≤11	0.10-0.15	≤11	0.10-0.15	
		0.25-0.5DC	● ● ✖	≤11	0.10-0.15	≤11	0.10-0.15	
			● ● ✖	≤11	0.08-0.12	≤11	0.10-0.15	
		0.5-0.75DC	● ● ✖	≤8	0.08-0.12	≤8	0.08-0.15	
			● ● ✖	≤8	0.06-0.15	≤8	0.08-0.15	
DC(rainure)	● ● ✖	≤5	0.06-0.15	≤5	0.08-0.15			
	● ● ✖	≤5	0.06-0.15	≤5	0.08-0.15			
H	Acier trempé	Dureté 40-55HRC	● ● ✖	≤5	0.08-0.15	≤5	0.08-0.15	
			● ● ✖	≤5	0.08-0.12	≤5	0.08-0.12	
			● ● ✖	≤4	0.08-0.12	≤4	0.08-0.12	
			● ● ✖	≤4	0.06-0.10	≤4	0.06-0.10	
		0.25-0.5DC	● ● ✖	≤4	0.06-0.10	≤4	0.06-0.10	
			● ● ✖	≤3	0.06-0.10	≤3	0.06-0.10	
		0.5-0.75DC	● ● ✖	≤3	0.06-0.08	≤3	0.06-0.08	
			● ● ✖	≤3	0.06-0.08	≤3	0.06-0.08	
DC(rainure)	● ● ✖	≤2	0.06-0.10	≤2	0.06-0.10			
	● ● ✖	≤2	0.06-0.08	≤2	0.06-0.08			

Remarque 1) Ces conditions de coupe s'appliquent aux outils courts à queue cylindrique (référence terminant en S) ou à attachement par alésage. En cas de vibration ou d'écaillage de plaquette, veuillez ajuster les conditions de coupe.

Remarque 2) Les vibrations sont plus probables dans les conditions suivantes :

- Avance par dent faible ou inférieure aux préconisations.
- Porte-à-faux important (queue longue, rallonge à visser, etc.).
- Faible raideur de machine, de pièce ou de bridage.
- Dans les angles en usinage de poches.

Remarque 3) Un pas plus grossier est recommandé pour un engagement radial (ae) supérieur à 0,5x DC.

Remarque 4) Il est recommandé d'usiner sous arrosage pour obtenir de meilleurs états de surface. (La durée de vie de l'outil est plus courte qu'en usinage à sec)

Remarque 5) Lorsque les conditions de coupe sont supérieures à celles recommandées, ou lorsque les temps copeaux sont très longs, les vis de plaquettes peuvent se fissurer. Veuillez remplacer les vis de plaquettes.

K

FRAISES À PLAQUETTES

FRAISES À PLAQUETTES

CONDITIONS DE COUPE RECOMMANDÉES

■ Coupe lubrifiée

Vitesse de coupe

Matière	Propriétés	Conditions de stabilité	Plaquelette	ae (mm)				
				Nuance	≤0.25DC	0.25–0.5DC	0.5–0.75DC	DC(rainure)
					Vc (m/min)			
P	Acier doux	Dureté ≤180HB	● ● ✖	MP6120 MP6130 VP15TF	140 (100–190)	130 (90–180)	100 (70–120)	100 (70–120)
	Acier carbone Alliage acier Acier outil	Dureté 180–350HB ≤350HB (recuit)	● ● ✖	MP6120 MP6130 VP15TF	120 (90–140)	110 (80–130)	100 (70–120)	100 (70–120)
	Acier pré-traité	Dureté 35–45HRC	● ● ✖	MP6120 MP6130 VP15TF	100 (80–120)	90 (70–110)	80 (60–100)	80 (60–100)
M	Acier inoxydable austénitique	Dureté ≤200HB	● ● ✖	MP7130, VP15TF	120 (100–150)	110 (90–140)	90 (70–120)	90 (70–120)
		Dureté >200HB	● ● ✖	MP7130, VP15TF	100 (80–130)	90 (70–120)	70 (50–100)	70 (50–100)
	Acier inoxydable duplex	Dureté ≤280HB	● ● ✖	MP7130, VP15TF	100 (80–130)	90 (70–120)	70 (50–100)	70 (50–100)
	Aciers inoxydables ferritiques et martensitiques	–	● ● ✖	MP7130, VP15TF	120 (100–150)	110 (90–140)	90 (70–120)	90 (70–120)
	Acier inoxydable à durcissement structural	Dureté <450HB	● ● ✖	MP7130, VP15TF	90 (70–120)	80 (60–110)	60 (40–90)	60 (40–90)
K	Fonte grise	Résistance à la traction ≤350MPa	● ● ✖	MC5020	180 (160–220)	170 (150–210)	150 (130–190)	150 (130–190)
			● ● ✖	VP15TF	130 (100–150)	120 (90–140)	100 (80–120)	100 (80–120)
	Fonte ductile	Résistance à la traction ≤800MPa	● ● ✖	MC5020	160 (140–180)	150 (130–170)	130 (110–150)	130 (110–150)
			● ● ✖	VP15TF	110 (80–140)	100 (70–130)	80 (60–120)	80 (60–120)
N	Alliage aluminium	Content Si <5%	● ● ✖	TF15	600 (400–1000)	600 (400–1000)	600 (400–1000)	600 (400–1000)
S	Alliage titane (Ti-6Al-4V, etc.)	–	● ● ✖	MP9120, VP15TF	50 (40–70)	50 (40–70)	50 (40–70)	50 (40–70)
			● ✖	MP9130	40 (30–60)	40 (30–60)	40 (30–60)	40 (30–60)
	Alliage titane (Ti-5Al-5V-5Mo-3Cr, etc.)	–	● ● ✖	MP9120, VP15TF	30 (20–40)	30 (20–40)	30 (20–40)	30 (20–40)
			● ✖	MP9130	30 (20–40)	30 (20–40)	30 (20–40)	30 (20–40)
	Alliage réfractaire	–	● ● ✖	MP9120, VP15TF	40 (30–60)	40 (30–60)	40 (30–60)	40 (30–60)
			● ✖	MP9130	30 (20–40)	30 (20–40)	30 (20–40)	30 (20–40)
H	Acier trempé	Dureté 40–55HRC	● ● ✖	VP15TF	90 (70–100)	85 (60–100)	70 (50–80)	70 (50–80)

Remarque 1) Ces conditions de coupe s'appliquent aux outils courts à queue cylindrique (référence terminant en S) ou à attachement par alésage. En cas de vibration ou d'écaillage de plaquelette, veuillez ajuster les conditions de coupe.

Remarque 2) Les vibrations sont plus probables dans les conditions suivantes :

- Avance par dent faible ou inférieure aux préconisations.
- Porte-à-faux important (queue longue, rallonge à visser, etc.).
- Faible raideur de machine, de pièce ou de bridage.
- Dans les angles en usinage de poches.

Remarque 3) Un pas plus grossier est recommandé pour un engagement radial (ae) supérieur à 0,5x DC.

Remarque 4) Il est recommandé d'usiner sous arrosage pour obtenir de meilleurs états de surface.

(La durée de vie de l'outil est plus courte qu'en usinage à sec)

Remarque 5) Lorsque les conditions de coupe sont supérieures à celles recommandées, ou lorsque les temps copeaux sont très longs, les vis de plaquelettes peuvent se fissurer. Veuillez remplacer les vis de plaquelettes.

K

FRAISES À PLAQUETTES

Conditions de coupe (Guide) :

● : Coupe Stable ● : Coupe Générale ✖ : Coupe Instable

Profondeur de Passe / Avance par Dent

Matière	Propriétés	ae (mm)	Conditions de stabilité	DC (mm)				
				ø25		ø28-ø80		
				ap (mm)	fz (mm/dent)	ap (mm)	fz (mm/dent)	
P	Acier doux	≤0.25DC	● ● ✖	≤11	0.10-0.20	≤11	0.10-0.30	
		0.25-0.5DC	● ● ✖	≤11	0.10-0.15	≤11	0.10-0.25	
		0.5-0.75DC	● ● ✖	≤8	0.08-0.12	≤8	0.10-0.20	
		DC(rainure)	● ● ✖	≤5	0.06-0.10	≤5	0.08-0.15	
	Acier carbone Alliage acier Acier outil	Dureté 180-280HB	≤0.25DC	● ● ✖	≤11	0.10-0.20	≤11	0.10-0.30
			0.25-0.5DC	● ● ✖	≤11	0.10-0.15	≤11	0.10-0.25
			0.5-0.75DC	● ● ✖	≤8	0.08-0.12	≤8	0.10-0.20
			DC(rainure)	● ● ✖	≤5	0.06-0.10	≤5	0.08-0.15
	Acier carbone Alliage acier Acier outil	Dureté 280-350HB ≤350HB (recuit)	≤0.25DC	● ● ✖	≤11	0.10-0.15	≤11	0.10-0.25
			0.25-0.5DC	● ● ✖	≤11	0.08-0.12	≤11	0.10-0.20
			0.5-0.75DC	● ● ✖	≤8	0.06-0.10	≤8	0.10-0.15
			DC(rainure)	● ● ✖	≤5	0.06-0.10	≤5	0.08-0.12
	Acier pré-traité	Dureté 35-45HRC	≤0.25DC	● ● ✖	≤11	0.10-0.15	≤11	0.10-0.25
			0.25-0.5DC	● ● ✖	≤11	0.08-0.12	≤11	0.10-0.20
			0.5-0.75DC	● ● ✖	≤8	0.06-0.10	≤8	0.10-0.15
			DC(rainure)	● ● ✖	≤5	0.06-0.10	≤5	0.08-0.12
M	Acier inoxydable austénitique	≤0.25DC	● ● ✖	≤11	0.10-0.20	≤11	0.10-0.20	
			● ● ✖	≤11	0.08-0.15	≤11	0.08-0.15	
		0.25-0.5DC	● ● ✖	≤11	0.08-0.12	≤11	0.08-0.15	
			● ● ✖	≤11	0.06-0.10	≤11	0.08-0.12	
		0.5-0.75DC	● ● ✖	≤8	0.06-0.10	≤8	0.08-0.12	
			● ● ✖	≤8	0.06-0.10	≤8	0.06-0.10	
		DC(rainure)	● ● ✖	≤5	0.06-0.10	≤5	0.06-0.10	
			● ● ✖	≤5	0.06-0.08	≤5	0.06-0.08	
	Acier inoxydable duplex	Dureté ≤280HB	≤0.25DC	● ● ✖	≤11	0.10-0.20	≤11	0.10-0.20
				● ● ✖	≤11	0.08-0.15	≤11	0.08-0.15
			0.25-0.5DC	● ● ✖	≤11	0.08-0.15	≤11	0.08-0.15
				● ● ✖	≤11	0.08-0.12	≤11	0.08-0.12
			0.5-0.75DC	● ● ✖	≤8	0.08-0.12	≤8	0.08-0.12
	DC(rainure)	● ● ✖	≤5	0.06-0.10	≤5	0.06-0.10		
	Aciers inoxydables ferritiques et martensitiques	-	≤0.25DC	● ● ✖	≤11	0.10-0.20	≤11	0.10-0.20
				● ● ✖	≤11	0.08-0.15	≤11	0.08-0.15
			0.25-0.5DC	● ● ✖	≤11	0.08-0.15	≤11	0.08-0.15
				● ● ✖	≤11	0.08-0.12	≤11	0.08-0.12
			0.5-0.75DC	● ● ✖	≤8	0.08-0.12	≤8	0.08-0.12
	DC(rainure)	● ● ✖	≤5	0.06-0.10	≤5	0.06-0.10		
Acier inoxydable à durcissement structural	Dureté <450HB	≤0.25DC	● ● ✖	≤11	0.10-0.15	≤11	0.10-0.15	
			● ● ✖	≤11	0.08-0.12	≤11	0.08-0.12	
		0.25-0.5DC	● ● ✖	≤11	0.08-0.12	≤11	0.08-0.12	
			● ● ✖	≤11	0.08-0.12	≤11	0.08-0.12	
		0.5-0.75DC	● ● ✖	≤8	0.06-0.10	≤8	0.06-0.10	
DC(rainure)	● ● ✖	≤5	0.06-0.10	≤5	0.06-0.10			
Acier inoxydable à durcissement structural	Dureté <450HB	≤0.25DC	● ● ✖	≤11	0.10-0.15	≤11	0.10-0.15	
			● ● ✖	≤11	0.08-0.12	≤11	0.08-0.12	
		0.25-0.5DC	● ● ✖	≤11	0.08-0.12	≤11	0.08-0.12	
			● ● ✖	≤11	0.08-0.12	≤11	0.08-0.12	
		0.5-0.75DC	● ● ✖	≤8	0.06-0.10	≤8	0.06-0.10	
DC(rainure)	● ● ✖	≤5	0.06-0.10	≤5	0.06-0.10			

Remarque 1) Ces conditions de coupe s'appliquent aux outils courts à queue cylindrique (référence terminant en S) ou à attachement par alésage. En cas de vibration ou d'écaillage de plaquette, veuillez ajuster les conditions de coupe.

Remarque 2) Les vibrations sont plus probables dans les conditions suivantes :

- Avance par dent faible ou inférieure aux préconisations.
- Porte-à-faux important (queue longue, rallonge à visser, etc.).
- Faible raideur de machine, de pièce ou de bridage.
- Dans les angles en usinage de poches.

Remarque 3) Un pas plus grossier est recommandé pour un engagement radial (ae) supérieur à 0,5x DC.

Remarque 4) Il est recommandé d'usiner sous arrosage pour obtenir de meilleurs états de surface.

(La durée de vie de l'outil est plus courte qu'en usinage à sec)

Remarque 5) Lorsque les conditions de coupe sont supérieures à celles recommandées, ou lorsque les temps copeaux sont très longs, les vis de plaquettes peuvent se fissurer. Veuillez remplacer les vis de plaquettes.

K

FRAISES À PLAQUETTES

CONDITIONS DE COUPE RECOMMANDÉES

■ Coupe lubrifiée

Profondeur de Passe / Avance par Dent

Matière	Propriétés	ae (mm)	Conditions de stabilité	DC (mm)					
				ø25		ø28-ø80			
				ap (mm)	fz (mm/dent)	ap (mm)	fz (mm/dent)		
K	Fonte grise	≤0.25DC	● ● ✖	≤11	0.10-0.20	≤11	0.10-0.30		
			● ● ✖	≤11	0.08-0.15	≤11	0.10-0.25		
		0.25-0.5DC	● ● ✖	≤11	0.08-0.15	≤11	0.10-0.25		
			● ● ✖	≤11	0.08-0.12	≤11	0.10-0.20		
		0.5-0.75DC	● ● ✖	≤8	0.08-0.12	≤8	0.10-0.20		
			● ● ✖	≤8	0.06-0.10	≤8	0.08-0.15		
		DC(rainure)	● ● ✖	≤5	0.06-0.10	≤5	0.08-0.15		
			● ● ✖	≤5	0.06-0.08	≤5	0.08-0.12		
		Fonte ductile	Résistance à la traction ≤800MPa	≤0.25DC	● ● ✖	≤11	0.10-0.20	≤11	0.10-0.25
					● ● ✖	≤11	0.10-0.15	≤11	0.10-0.20
0.25-0.5DC	● ● ✖			≤11	0.10-0.15	≤11	0.10-0.20		
	● ● ✖			≤11	0.08-0.12	≤11	0.10-0.15		
0.5-0.75DC	● ● ✖			≤8	0.08-0.12	≤8	0.10-0.15		
	● ● ✖			≤8	0.06-0.10	≤8	0.08-0.12		
DC(rainure)	● ● ✖			≤5	0.06-0.10	≤5	0.08-0.12		
	● ● ✖			≤5	0.06-0.08	≤5	0.06-0.10		
N	Alliage aluminium			≤0.25DC	● ● ✖	≤11	0.10-0.25	≤11	0.10-0.25
					● ● ✖	≤11	0.10-0.20	≤11	0.10-0.20
		0.25-0.5DC	● ● ✖	≤11	0.10-0.20	≤11	0.10-0.20		
			● ● ✖	≤11	0.10-0.15	≤11	0.10-0.15		
		0.5-0.75DC	● ● ✖	≤8	0.06-0.15	≤8	0.08-0.15		
			● ● ✖	≤8	0.06-0.15	≤8	0.08-0.15		
		DC(rainure)	● ● ✖	≤5	0.06-0.15	≤5	0.08-0.15		
			● ● ✖	≤5	0.06-0.15	≤5	0.08-0.12		
		S	Alliage titane (Ti-6Al-4V, etc.)	≤0.25DC	● ● ✖	≤11	0.08-0.15	≤11	0.08-0.15
				0.25-0.5DC	● ● ✖	≤11	0.08-0.12	≤11	0.08-0.12
0.5-0.75DC	● ● ✖			≤8	0.06-0.10	≤8	0.06-0.10		
DC(rainure)	● ● ✖			≤5	0.06-0.10	≤5	0.06-0.10		
Alliage titane (Ti-5Al-5V-5Mo-3Cr, etc.)	≤0.25DC		● ● ✖	≤11	0.08-0.12	≤11	0.08-0.12		
	0.25-0.5DC		● ● ✖	≤11	0.08-0.12	≤11	0.08-0.12		
	0.5-0.75DC		● ● ✖	≤8	0.06-0.10	≤8	0.06-0.10		
	DC(rainure)		● ● ✖	≤5	0.06-0.10	≤5	0.06-0.10		
Alliage réfractaire	≤0.25DC		● ● ✖	≤11	0.08-0.12	≤11	0.08-0.12		
	0.25-0.5DC		● ● ✖	≤11	0.08-0.12	≤11	0.08-0.12		
	0.5-0.75DC		● ● ✖	≤8	0.06-0.10	≤8	0.06-0.10		
	DC(rainure)		● ● ✖	≤5	0.06-0.10	≤5	0.06-0.10		
H	Acier trempé	≤0.25DC	● ● ✖	≤5	0.08-0.15	≤5	0.08-0.15		
			● ● ✖	≤5	0.08-0.12	≤5	0.08-0.12		
		0.25-0.5DC	● ● ✖	≤4	0.08-0.12	≤4	0.08-0.12		
			● ● ✖	≤4	0.06-0.10	≤4	0.06-0.10		
		0.5-0.75DC	● ● ✖	≤3	0.06-0.10	≤3	0.06-0.10		
			● ● ✖	≤3	0.06-0.10	≤3	0.06-0.08		
		DC(rainure)	● ● ✖	≤2	0.06-0.10	≤2	0.06-0.10		
			● ● ✖	≤2	0.06-0.10	≤2	0.06-0.08		

Remarque 1) Ces conditions de coupe s'appliquent aux outils courts à queue cylindrique (référence terminant en S) ou à attachement par alésage. En cas de vibration ou d'écaillage de plaquette, veuillez ajuster les conditions de coupe.

Remarque 2) Les vibrations sont plus probables dans les conditions suivantes :

- Avance par dent faible ou inférieure aux préconisations.
- Porte-à-faux important (queue longue, rallonge à visser, etc.).
- Faible raideur de machine, de pièce ou de bridage.
- Dans les angles en usinage de poches.

Remarque 3) Un pas plus grossier est recommandé pour un engagement radial (ae) supérieur à 0,5x DC.

Remarque 4) Il est recommandé d'usiner sous arrosage pour obtenir de meilleurs états de surface.

(La durée de vie de l'outil est plus courte qu'en usinage à sec)

Remarque 5) Lorsque les conditions de coupe sont supérieures à celles recommandées, ou lorsque les temps copeaux sont très longs, les vis de plaquettes peuvent se fissurer. Veuillez remplacer les vis de plaquettes.

■ Ramping / Interpolation Hélicoïdale

● Ramping

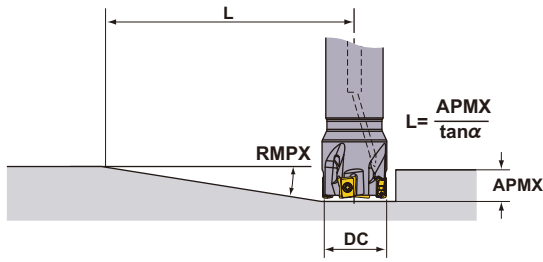

● Interpolation Hélicoïdale

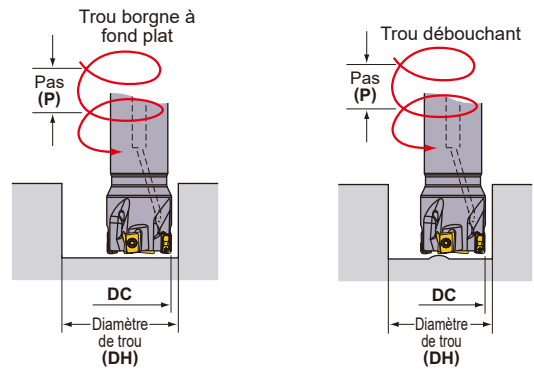

Se référer au tableau ci-dessous pour les conditions de coupe. Pour l'avance par dent et la vitesse de coupe, se référer aux conditions de coupe pour rainurage.

DC (mm)	RE (mm)	Ramping		Interpolation Hélicoïdale (Trou borgne à fond plat)				Interpolation Hélicoïdale (Trou débouchant)	
		RMPX	L (mm) *	DH max. (mm)	P max. (mm)	DH min. (mm)	P max. (mm)	DH min. (mm)	P max. (mm)
25	0.2	2.13°	296	49.0	2.8	42.7	2.1	36.9	1.4
	0.4	2.13°	296	48.6	2.8	42.7	2.1	36.9	1.4
	0.8	2.13°	296	47.8	2.7	42.7	2.1	36.9	1.4
	1.0	2.13°	296	47.4	2.6	42.7	2.1	36.9	1.4
	1.2	2.13°	296	47.0	2.6	42.7	2.1	36.9	1.4
	1.6	2.13°	296	46.2	2.5	42.7	2.1	36.9	1.4
	2.0	2.13°	296	45.4	2.4	42.7	2.1	36.9	1.4
	2.4	2.13°	296	44.6	2.3	42.7	2.1	36.9	1.4
	3.0	2.13°	296	43.4	2.2	42.7	2.1	36.9	1.4
3.2	2.13°	296	43.0	2.1	42.7	2.1	36.9	1.4	
28	0.2	1.77°	356	55.0	2.6	48.7	2.0	42.7	1.4
	0.4	1.77°	356	54.6	2.6	48.7	2.0	42.7	1.4
	0.8	1.77°	356	53.8	2.5	48.7	2.0	42.7	1.4
	1.0	1.77°	356	53.4	2.5	48.7	2.0	42.7	1.4
	1.2	1.77°	356	53.0	2.4	48.7	2.0	42.7	1.4
	1.6	1.77°	356	52.2	2.4	48.7	2.0	42.7	1.4
	2.0	1.77°	356	51.4	2.3	48.7	2.0	42.7	1.4
	2.4	1.77°	356	50.6	2.2	48.7	2.0	42.7	1.4
	3.0	1.77°	356	49.4	2.1	48.7	2.0	42.7	1.4
3.2	1.77°	356	49.0	2.0	48.7	2.0	42.7	1.4	
30	0.2	1.61°	392	59.0	2.6	52.7	2.0	46.6	1.5
	0.4	1.61°	392	58.6	2.5	52.7	2.0	46.6	1.5
	0.8	1.61°	392	57.8	2.5	52.7	2.0	46.6	1.5
	1.0	1.61°	392	57.4	2.4	52.7	2.0	46.6	1.5
	1.2	1.61°	392	57.0	2.4	52.7	2.0	46.6	1.5
	1.6	1.61°	392	56.2	2.3	52.7	2.0	46.6	1.5
	2.0	1.61°	392	55.4	2.2	52.7	2.0	46.6	1.5
	2.4	1.61°	392	54.6	2.2	52.7	2.0	46.6	1.5
	3.0	1.61°	392	53.4	2.1	52.7	2.0	46.6	1.5
3.2	1.61°	392	53.0	2.0	52.7	2.0	46.6	1.5	
32	0.2	1.47°	429	63.0	2.5	56.7	2.0	50.6	1.5
	0.4	1.47°	429	62.6	2.5	56.7	2.0	50.6	1.5
	0.8	1.47°	429	61.8	2.4	56.7	2.0	50.6	1.5
	1.0	1.47°	429	61.4	2.4	56.7	2.0	50.6	1.5
	1.2	1.47°	429	61.0	2.3	56.7	2.0	50.6	1.5
	1.6	1.47°	429	60.2	2.3	56.7	2.0	50.6	1.5
	2.0	1.47°	429	59.4	2.2	56.7	2.0	50.6	1.5
	2.4	1.47°	429	58.6	2.1	56.7	2.0	50.6	1.5
	3.0	1.47°	429	57.4	2.1	56.7	2.0	50.6	1.5
3.2	1.47°	429	57.0	2.0	56.7	2.0	50.6	1.5	
35	0.2	1.28°	493	69.0	2.4	62.8	1.9	56.6	1.5
	0.4	1.28°	493	68.6	2.4	62.8	1.9	56.6	1.5
	0.8	1.28°	493	67.8	2.3	62.8	1.9	56.6	1.5
	1.0	1.28°	493	67.4	2.3	62.8	1.9	56.6	1.5
	1.2	1.28°	493	67.0	2.2	62.8	1.9	56.6	1.5
	1.6	1.28°	493	66.2	2.2	62.8	1.9	56.6	1.5
	2.0	1.28°	493	65.4	2.1	62.8	1.9	56.6	1.5
	2.4	1.28°	493	64.6	2.1	62.8	1.9	56.6	1.5
	3.0	1.28°	493	63.4	2.0	62.8	1.9	56.6	1.5
3.2	1.28°	493	63.0	2.0	62.8	1.9	56.6	1.5	

Remarque 1) L'usinage en ramping peut créer des copeaux longs dans les matières ductiles.

* Distance jusqu'à ce qu'une profondeur de coupe maximale de 11 mm soit atteinte à l'angle de ramping maximal $L = 11/\tan \alpha$.

FRAISES À PLAQUETTES

■ Ramping / Interpolation Hélicoïdale

● Ramping

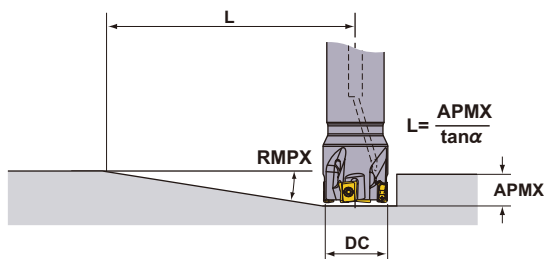

● Interpolation Hélicoïdale

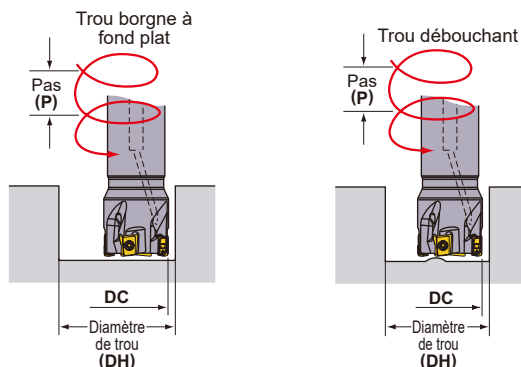

Se référer au tableau ci-dessous pour les conditions de coupe. Pour l'avance par dent et la vitesse de coupe, se référer aux conditions de coupe pour rainurage.

DC (mm)	RE (mm)	Ramping		Interpolation Hélicoïdale (Trou borgne à fond plat)				Interpolation Hélicoïdale (Trou débouchant)	
		RMPX	L (mm) *	DH max. (mm)	P max. (mm)	DH min. (mm)	P max. (mm)	DH min. (mm)	P max. (mm)
40	0.2	1.06°	595	78.8	2.3	72.7	1.9	66.5	1.5
	0.4	1.06°	595	78.4	2.2	72.7	1.9	66.5	1.5
	0.8	1.06°	595	77.6	2.2	72.7	1.9	66.5	1.5
	1.0	1.06°	595	77.2	2.2	72.7	1.9	66.5	1.5
	1.2	1.06°	595	76.8	2.1	72.7	1.9	66.5	1.5
	1.6	1.06°	595	76.0	2.1	72.7	1.9	66.5	1.5
	2.0	1.06°	595	75.2	2.0	72.7	1.9	66.5	1.5
	2.4	1.06°	595	74.4	2.0	72.7	1.9	66.5	1.5
	3.0	1.06°	595	73.2	1.9	72.7	1.9	66.5	1.5
3.2	1.06°	595	72.8	1.9	72.7	1.9	66.5	1.5	
50	0.2	0.79°	798	98.8	2.1	92.7	1.8	86.5	1.6
	0.4	0.79°	798	98.4	2.1	92.7	1.8	86.5	1.6
	0.8	0.79°	798	97.6	2.1	92.7	1.8	86.5	1.6
	1.0	0.79°	798	97.2	2.0	92.7	1.8	86.5	1.6
	1.2	0.79°	798	96.8	2.0	92.7	1.8	86.5	1.6
	1.6	0.79°	798	96.0	2.0	92.7	1.8	86.5	1.6
	2.0	0.79°	798	95.2	2.0	92.7	1.8	86.5	1.6
	2.4	0.79°	798	94.4	1.9	92.7	1.8	86.5	1.6
	3.0	0.79°	798	93.2	1.9	92.7	1.8	86.5	1.6
3.2	0.79°	798	92.8	1.9	92.7	1.8	86.5	1.6	
63	0.2	0.6°	1051	124.8	2.0	118.7	1.8	112.5	1.6
	0.4	0.6°	1051	124.4	2.0	118.7	1.8	112.5	1.6
	0.8	0.6°	1051	123.6	2.0	118.7	1.8	112.5	1.6
	1.0	0.6°	1051	123.2	2.0	118.7	1.8	112.5	1.6
	1.2	0.6°	1051	122.8	2.0	118.7	1.8	112.5	1.6
	1.6	0.6°	1051	122.0	1.9	118.7	1.8	112.5	1.6
	2.0	0.6°	1051	121.2	1.9	118.7	1.8	112.5	1.6
	2.4	0.6°	1051	120.4	1.9	118.7	1.8	112.5	1.6
	3.0	0.6°	1051	119.2	1.9	118.7	1.8	112.5	1.6
3.2	0.6°	1051	118.8	1.8	118.7	1.8	112.5	1.6	
80	0.2	0.45°	1401	158.8	1.9	152.6	1.8	146.5	1.6
	0.4	0.45°	1401	158.4	1.9	152.7	1.8	146.5	1.6
	0.8	0.45°	1401	157.6	1.9	152.7	1.8	146.5	1.6
	1.0	0.45°	1401	157.2	1.9	152.7	1.8	146.5	1.6
	1.2	0.45°	1401	156.8	1.9	152.7	1.8	146.5	1.6
	1.6	0.45°	1401	156.0	1.9	152.7	1.8	146.5	1.6
	2.0	0.45°	1401	155.2	1.9	152.7	1.8	146.5	1.6
	2.4	0.45°	1401	154.4	1.8	152.7	1.8	146.5	1.6
	3.0	0.45°	1401	153.2	1.8	152.7	1.8	146.5	1.6
3.2	0.45°	1401	152.8	1.8	152.7	1.8	146.5	1.6	

Remarque 1) L'usinage en ramping peut créer des copeaux longs dans les matières ductiles.

* Distance jusqu'à ce qu'une profondeur de coupe maximale de 11 mm soit atteinte à l'angle de ramping maximal $L = 11/\tan \alpha$.

K

FRAISES À PLAQUETTES

■ Tréflage et perçage

Voir les tableaux de droite pour les engagements et profondeurs de perçage. Pour l'avance par dent et la vitesse de coupe, veuillez utiliser les conditions de coupe pour le rainurage.

● Tréflage

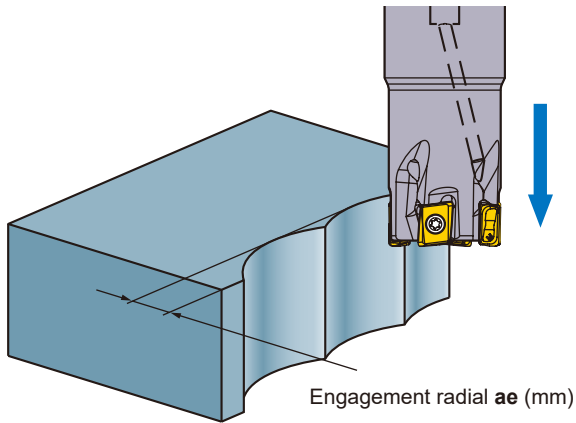

DC (mm)	ae max. (mm)
25	6.5
28	6.6
30	6.6
32	6.6
35	6.7
40	6.7
50	6.7
63	6.7
80	6.7

Remarque 1) Un cycle de déburrage n'est pas nécessaire.

● Perçage

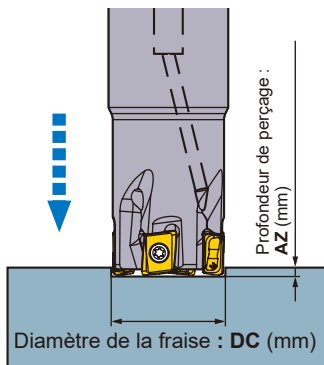

DC (mm)	AZ max. (mm)
25	0.55
28	0.55
30	0.55
32	0.55
35	0.55
40	0.55
50	0.55
63	0.55
80	0.55

Remarque 1) Attention aux projections de copeaux.

Remarque 2) Évacuez les copeaux à l'aide d'air comprimé (ou de liquide d'arrosage lors de l'usinage d'un alliage d'aluminium).

FRAISES À PLAQUETTES

FRAISES À SURFACER-DRESSER



VPX200

NEW

SÉRIE LONGUE

P

M

K

N

S

H

K

FRAISES À PLAQUETTES



Fig.1

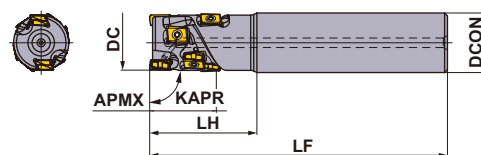
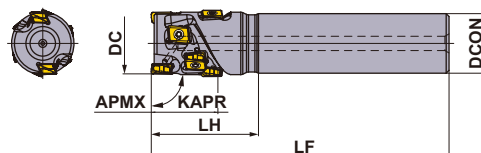

Fig.2



Outil à droite uniquement.

ATTACHEMENT CYLINDRIQUE

Avec trou de lubrification

DC (mm)	Référence	Stock R	Nbre goujures	Total	Dimensions (mm)			APMX (mm)	RMPX	WT ^{*2} (kg)	Fig.	Type Plaque
					DCON	LF	LH					
20	VPX200R202SA20S01404	●	2	4	20	100	30	14	1.35°	0.21	1	LOGU09
22	VPX200R222SA20S01404	●	2	4	20	115	30	14	1.16°	0.26	2	LOGU09
25	VPX200R252SA25S02106	●	2	6	25	115	35	21	0.97°	0.39	1	LOGU09
25	VPX200R252SA25S02808	●	2	8	25	125	45	28	0.97°	0.41	1	LOGU09
28	VPX200R282SA25S02106	★	2	6	25	115	35	21	0.84°	0.40	2	LOGU09
28	VPX200R282SA25S02808	★	2	8	25	125	45	28	0.84°	0.43	2	LOGU09
32	VPX200R322SA32S02808	★	2	8	32	125	45	28	0.71°	0.68	1	LOGU09
32	VPX200R323SA32S02812	●	3	12	32	125	45	28	0.71°	0.67	1	LOGU09
32	VPX200R322SA32S03510	★	2	10	32	130	50	35	0.71°	0.70	1	LOGU09
32	VPX200R323SA32S03515	●	3	15	32	130	50	35	0.71°	0.68	1	LOGU09
35	VPX200R352SA32S02808	★	2	8	32	125	45	28	0.63°	0.72	2	LOGU09
35	VPX200R353SA32S02812	★	3	12	32	125	45	28	0.63°	0.71	2	LOGU09
35	VPX200R352SA32S03510	★	2	10	32	130	50	35	0.63°	0.74	2	LOGU09
35	VPX200R353SA32S03515	★	3	15	32	130	50	35	0.63°	0.73	2	LOGU09
40	VPX200R403SA32S03515	★	3	15	32	130	50	35	0.54°	0.81	2	LOGU09
40	VPX200R404SA32S03520	●	4	20	32	130	50	35	0.54°	0.80	2	LOGU09
40	VPX200R403SA32S04218	★	3	18	32	140	60	42	0.54°	0.88	2	LOGU09
40	VPX200R404SA32S04224	★	4	24	32	140	60	42	0.54°	0.86	2	LOGU09

*1 Le rayon RE doit être inférieur ou égal à 0,8 mm, sauf pour la rangée de plaquettes en bout de fraise.

Les plaquettes RE 0,2 mm et 0,4 mm peuvent également être utilisées en bout de fraise.

*2 WT : Poids de l'outil

PIÈCES DÉTACHÉES

DC (mm)	Référence porte-outil	* Vis de serrage			* Clé			* Anti-grippant		
		Vis de serrage	Clé	Anti-grippant						
20	VPX200R20	TPS27F1	TIP07F	MK1KS						
22	VPX200R22	TPS27F2	TIP07F	MK1KS						
25	VPX200R25	TPS27F2	TIP07F	MK1KS						
28	VPX200R28	TPS27F2	TIP07F	MK1KS						
32	VPX200R32	TPS27F2	TIP07F	MK1KS						
35	VPX200R35	TPS27F2	TIP07F	MK1KS						
40	VPX200R40	TPS27F2	TIP07F	MK1KS						

* Couple de serrage (N • m) : TPS27F1 = 1,0, TPS27F2 = 1,0

● : Article stocké. ★ : Article standard Japon.



Fig.1

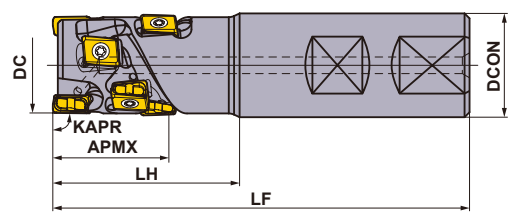

Outil à droite uniquement.

■ ATTACHEMENT WELDON

Avec trou de lubrification

DC (mm)	Référence	Stock	Nbre goujures	Total	Dimensions (mm)			APMX (mm)	RMPX	WT ^{*2} (kg)	Fig.	Type Plaque
		R			DCON	LF	LH					
20	VPX200R202WA20S01404	●	2	4	20	80	30	14	1.35°	0.16	1	LOGU09
25	VPX200R252WA25S02106	●	2	6	25	91	35	21	0.97°	0.29	1	LOGU09
25	VPX200R252WA25S02808	●	2	8	25	101	45	28	0.97°	0.32	1	LOGU09
32	VPX200R322WA32S02808	●	2	8	32	105	45	28	0.71°	0.55	1	LOGU09
32	VPX200R323WA32S02812	●	3	12	32	105	45	28	0.71°	0.54	1	LOGU09
32	VPX200R322WA32S03510	●	2	10	32	110	50	35	0.71°	0.57	1	LOGU09
32	VPX200R323WA32S03515	●	3	15	32	110	50	35	0.71°	0.55	1	LOGU09

*1 Le rayon RE doit être inférieur ou égal à 0,8 mm, sauf pour la rangée de plaquettes en bout de fraise.

Les plaquettes RE 0,2 mm et 0,4 mm peuvent également être utilisées en bout de fraise.

*2 WT : Poids de l'outil

PIÈCES DÉTACHÉES

DC (mm)	Référence porte-outil	* Pièces détachées		
		Vis de serrage	Clé	Anti-grippant
20	VPX200R20	TPS27F1	TIP07F	MK1KS
25	VPX200R25	TPS27F2	TIP07F	MK1KS
32	VPX200R32	TPS27F2	TIP07F	MK1KS

* Couple de serrage (N • m) : TPS27F1 = 1,0, TPS27F2 = 1,0

FRAISES À PLAQUETTES

K

FRAISES À PLAQUETTES



Fig.1

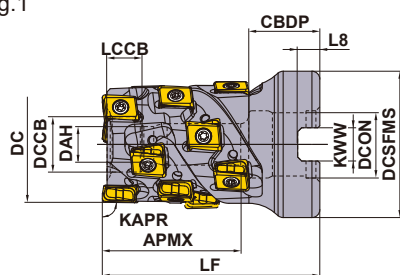
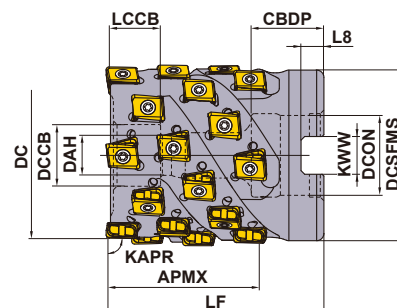

Fig.2



Outil à droite uniquement.

■ FRAISE à ALÉSAGE

KAPR: 90°
GAMP: -6° GAMP: -25°
Avec trou de lubrification

DC (mm)	APMX	Vis d'attachement	Géométrie
φ32	35	HSC08045	
φ40	42	HSC08050	
φ50	42	HSC10045	

DC (mm)	Référence	Stock R	Nbre goujures	Total	Dimensions (mm)		WT ^{*2} (kg)	APMX (mm)	RMPX	Fig.	Type Plaquette ^{*1}
					LF	DCON					
32	VPX200-032A02A035R10	★	2	10	55	16	0.22	35	0.71°	1	LOGU09
32	VPX200-032A03A035R15	●	3	15	55	16	0.20	35	0.71°	1	LOGU09
40	VPX200-040A03A042R18	★	3	18	60	16	0.34	42	0.54°	2	LOGU09
40	VPX200-040A04A042R24	●	4	24	60	16	0.33	42	0.54°	2	LOGU09
50	VPX200-050A04A042R24	★	4	24	60	22	0.55	42	0.42°	2	LOGU09
50	VPX200-050A05A042R30	★	5	30	60	22	0.54	42	0.42°	2	LOGU09

*1 Le rayon RE doit être inférieur ou égal à 0,8 mm, sauf pour la rangée de plaquettes en bout de fraise.

Les plaquettes RE 0,2 mm et 0,4 mm peuvent également être utilisées en bout de fraise.

*2 WT : Poids de l'outil

DIMENSIONS DE MONTAGE

DC (mm)	Référence	Dimensions (mm)							
		DCON	CBDP	DAH	DCCB	LCCB	DCSFMS	KWW	L8
32	VPX200-032A02A035R10	16	18	9	14	8	37	8.4	5.6
32	VPX200-032A03A035R15	16	18	9	14	8	37	8.4	5.6
40	VPX200-040A03A042R18	16	18	9	14	8	37	8.4	5.6
40	VPX200-040A04A042R24	16	18	9	14	8	37	8.4	5.6
50	VPX200-050A04A042R24	22	20	11	17	13	47	10.4	6.3
50	VPX200-050A05A042R30	22	20	11	17	13	47	10.4	6.3

PIÈCES DÉTACHÉES



Porte-outil Type	*		
VPX200	TPS27F2	TIP07F	MK1KS

* Couple de serrage (N • m) : TPS27F2 = 1,0

● : Article stocké. ★ : Article standard Japon.

(10 plaquettes par boîte)

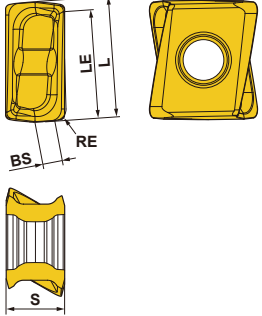
PLAQUETTES

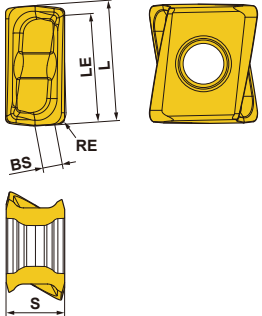
Matière	P	Acier							Conditions de coupe (Guide):					Géométrie							
	M	Acier Inoxydable							● : Coupe Stable ● : Coupe Générale ✦ : Coupe Instable												
Matière	K	Fonte							Honing :					Géométrie							
	N	Non ferreux							E : Ronde F : Affûtée												
	S	Alliage réfractaire, Alliage titane																			
Matière	H	Acier trempé												Géométrie							
Forme	Référence	Classe	Honing	Revêtu						Carbure	Dimensions (mm)										
				MC5020	MP6120	MP6130	MP7130	MP9120	MP9130	VP15TF	TF15	L	RE	LE	S	BS					
Faible effort de coupe Brise-copeaux L NEW 	LOGU0904020PNER-L	G E	★	★	★	★	★	★	★	★	★			8.7	0.2	7.6	4.3	1.7	 Outil représenté à droite.		
	LOGU0904040PNER-L	G E	●	●	●	●	●	●	★					8.7	0.4	7.6	4.3	1.5			
	LOGU0904080PNER-L	G E	●	●	●	●	●	●	★					8.7	0.8	7.6	4.3	1.2			
	LOGU0904100PNER-L	G E	★	★	★	★	★	★	★					8.7	1.0	7.6	4.3	1.0			
	LOGU0904120PNER-L	G E	★	★	★	★	★	★	★					8.7	1.2	7.6	4.3	0.8			
	LOGU0904160PNER-L	G E	●	●	●	●	●	●	★					8.7	1.6	7.6	4.3	0.5			
	LOGU0904020PNFR-L	G F								●				8.7	0.2	7.6	4.3	1.7			
	LOGU0904040PNFR-L	G F								●				8.7	0.4	7.6	4.3	1.5			
	LOGU0904080PNFR-L	G F								●				8.7	0.8	7.6	4.3	1.2			
	LOGU0904100PNFR-L	G F								★				8.7	1.0	7.6	4.3	1.0			
	LOGU0904120PNFR-L	G F								★				8.7	1.2	7.6	4.3	0.8			
	LOGU0904160PNFR-L	G F								★				8.7	1.6	7.6	4.3	0.5			
	Usage général Brise-copeaux M 	LOGU0904020PNER-M	G E	★	★	★	★	★	★	★					8.7	0.2	7.6	4.3		1.7	 Outil représenté à droite.
		LOGU0904040PNER-M	G E	●	●	●	●	●	●	★					8.7	0.4	7.6	4.3		1.6	
LOGU0904080PNER-M		G E	●	●	●	●	●	●	★					8.7	0.8	7.6	4.3	1.2			
LOGU0904100PNER-M		G E	★	★	★	★	★	★	★					8.7	1.0	7.6	4.3	1.0			
LOGU0904120PNER-M		G E	★	★	★	★	★	★	★					8.7	1.2	7.6	4.3	0.9			
LOGU0904160PNER-M		G E	●	●	●	●	●	●	★					8.7	1.6	7.6	4.3	0.5			
LOGU0904020PNFR-M		G F								●				8.7	0.2	7.6	4.3	1.7			
LOGU0904040PNFR-M		G F								●				8.7	0.4	7.6	4.3	1.6			
LOGU0904080PNFR-M		G F								●				8.7	0.8	7.6	4.3	1.2			
LOGU0904100PNFR-M		G F								★				8.7	1.0	7.6	4.3	1.0			
LOGU0904120PNFR-M		G F								★				8.7	1.2	7.6	4.3	0.9			
LOGU0904160PNFR-M		G F								★				8.7	1.6	7.6	4.3	0.5			

● ★ = NEW

RECOMMANDATIONS BRISE-COPEAUX

■ Sélection des brise-copeaux

Matière	Propriétés	Conditions de stabilité	Brise-Copeaux		Nuance		
			1ère recommandation	2ème recommandation	1ère recommandation	2ème recommandation	
P Acier doux	Dureté ≤180HB	● ●	L	M	MP6120	VP15TF	
		● ●	M	L	MP6130	—	
	Dureté 180-350HB ≤350HB (recuit)	● ●	L	M	MP6120	VP15TF	
		● ●	M	L	MP6120	VP15TF	
		● ●	M	L	MP6130	—	
	Acier pré-traité	Dureté 35–45HRC	● ●	M	L	MP6120	VP15TF
● ●			M	L	MP6130	—	
M	Acier inoxydable austénitique	Dureté ≤280HB	● ●	L	M	MP7130	VP15TF
		● ●	M	L	MP7130	—	
		Dureté >200HB	● ●	L	M	MP7130	VP15TF
		● ●	M	L	MP7130	—	
	Acier inoxydable duplex	Dureté ≤280HB	● ●	L	M	MP7130	VP15TF
			● ●	M	L	MP7130	—
	Aciers inoxydables ferritiques et martensitiques	—	● ●	L	M	MP7130	VP15TF
			● ●	M	L	MP7130	—
	Acier inoxydable à durcissement structural	Dureté <450HB	● ●	L	M	MP7130	VP15TF
			● ●	M	L	MP7130	—
K	Fonte grise	Résistance à la traction ≤350MPa	● ●	M	L	MC5020	VP15TF
		● ●	M	L	VP15TF	—	
	Fonte ductile	Résistance à la traction ≤800MPa	● ●	M	L	MC5020	VP15TF
			● ●	M	L	VP15TF	—
N	Alliage aluminium	Content Si <5%	● ●	L	M	TF15	—
			● ●	M	L	TF15	—
S	Alliage titane (Ti-6Al-4V, etc.)	—	● ●	L	M	MP9120	VP15TF
			● ●	M	L	MP9130	—
	Alliage titane (Ti-5Al-5V-5Mo-3Cr, etc.)	—	● ●	L	M	MP9120	VP15TF
			● ●	M	L	MP9130	—
	Alliage réfractaire	—	● ●	M	L	MP9120	VP15TF
● ●			M	L	MP9130	—	
H	Acier trempé	Dureté 40–55HRC	● ●	M	—	VP15TF	—

K

FRAISES À PLAQUETTES

Conditions de coupe (Guide) :

● : Coupe Stable ● : Coupe Générale ✚ : Coupe Instable

CONDITIONS DE COUPE RECOMMANDÉES

Vitesse de coupe

(mm)

Matière	Propriétés	Conditions de stabilité	Nuance	ae				Lubrification	
				≤0.25DC	0.25–0.5DC	0.5–0.75DC	DC(rainure)		
				Vc (m/min)					
P	Acier doux Dureté ≤180HB	● ●	MP6120,VP15TF	140(100–190)	130(90–180)	100(70–120)	100(70–120)	Sans, Avec	
		✚	MP6130	140(100–190)	130(90–180)	100(70–120)	100(70–120)	Sans, Avec	
	Acier carbone Acier allié Dureté 180–350HB	● ●	MP6120,VP15TF	120(90–140)	110(80–130)	100(70–120)	100(70–120)	Sans, Avec	
		✚	MP6130	120(90–140)	110(80–130)	100(70–120)	100(70–120)	Sans, Avec	
	Acier pré-traité Dureté 180–350HB	● ●	MP6120,VP15TF	100(80–120)	90(70–110)	80(60–100)	80(60–100)	Sans, Avec	
		✚	MP6130	100(80–120)	90(70–110)	80(60–100)	80(60–100)	Sans, Avec	
M	Acier inoxydable austénitique Dureté ≤200HB	● ●	MP7130,VP15TF	120(100–150)	110(90–140)	90(70–120)	90(70–120)	Sans, Avec	
		✚	MP7130	120(100–150)	110(90–140)	90(70–120)	90(70–120)	Sans, Avec	
		● ●	MP7130,VP15TF	100(80–130)	90(70–120)	70(50–100)	70(50–100)	Sans, Avec	
		✚	MP7130	100(80–130)	90(70–120)	70(50–100)	70(50–100)	Sans, Avec	
	Aciers inoxydables ferritiques et martensitiques	–	● ●	MP7130,VP15TF	120(100–150)	110(90–140)	90(70–120)	90(70–120)	Sans, Avec
		✚	MP7130	120(100–150)	110(90–140)	90(70–120)	90(70–120)	Sans, Avec	
	Acier inoxydable duplex Dureté ≤280HB	● ●	MP7130,VP15TF	100(80–130)	90(70–120)	70(50–100)	70(50–100)	Sans, Avec	
		✚	MP7130	100(80–130)	90(70–120)	70(50–100)	70(50–100)	Sans, Avec	
	Acier inoxydable à durcissement structural Dureté <450HB	● ●	MP7130,VP15TF	90(70–120)	80(60–110)	60(40–90)	60(40–90)	Sans, Avec	
		✚	MP7130	90(70–120)	80(60–110)	60(40–90)	60(40–90)	Sans, Avec	
	K	Fonte grise Résistance à la traction ≤350MPa	● ●	MC5020	180(160–220)	170(150–210)	150(130–190)	150(130–190)	Sans, Avec
			● ● ✚	VP15TF	130(100–150)	120(90–140)	100(80–120)	100(80–120)	Sans, Avec
Fonte ductile Résistance à la traction ≤800MPa		● ●	MC5020	160(140–180)	150(130–170)	130(110–150)	130(110–150)	Sans, Avec	
		● ● ✚	VP15TF	110(80–140)	100(70–130)	80(60–120)	80(60–120)	Sans, Avec	
N	Alliage aluminium Content Si <5%	● ● ✚	TF15	600(400–1000)	600(400–1000)	600(400–1000)	600(400–1000)	Sans, Avec	
S	Alliage titane (Ti-6Al-4V etc.)	● ●	MP9120	50(40–70)	50(40–70)	50(40–70)	50(40–70)	Avec	
		●	VP15TF	50(40–70)	50(40–70)	50(40–70)	50(40–70)	Avec	
		● ● ✚	MP9130	50(40–70)	50(40–70)	50(40–70)	50(40–70)	Avec	
	Alliage titane (Ti-6Al-5V-5Mo-3Cr etc.)	● ●	MP9120	30(20–40)	30(20–40)	30(20–40)	30(20–40)	Avec	
		●	VP15TF	30(20–40)	30(20–40)	30(20–40)	30(20–40)	Avec	
		● ● ✚	MP9130	30(20–40)	30(20–40)	30(20–40)	30(20–40)	Avec	
	Alliage réfractaire	● ●	MP9120	40(30–60)	40(30–60)	40(30–60)	40(30–60)	Avec	
		●	VP15TF	40(30–60)	40(30–60)	40(30–60)	40(30–60)	Avec	
		● ● ✚	MP9130	40(30–60)	40(30–60)	40(30–60)	40(30–60)	Avec	

Remarque 1) Ces conditions de coupe s'appliquent aux outils courts à queue cylindrique (référence terminant en S) ou à attachement par alésage. En cas de vibration ou d'écaillage de plaquette, veuillez ajuster les conditions de coupe.

Remarque 2) Les vibrations sont plus probables dans les conditions suivantes :

- Avance par dent faible ou inférieure aux préconisations.
- Porte-à-faux important (queue longue, rallonge à visser, etc.).
- Faible raideur de machine, de pièce ou de bridage.
- Dans les angles en usinage de poches.

Remarque 3) Un pas plus grossier est recommandé pour un engagement radial (ae) supérieur à 0,5x DC.

Remarque 4) Il est recommandé d'usiner sous arrosage pour obtenir de meilleurs états de surface.

(La durée de vie de l'outil est plus courte qu'en usinage à sec)

Remarque 5) Lorsque les conditions de coupe sont supérieures à celles recommandées, ou lorsque les temps copeaux sont très longs, les vis de plaquettes peuvent se fissurer. Veuillez remplacer les vis de plaquettes.

K

FRAISES À PLAQUETTES

FRAISES À PLAQUETTES

CONDITIONS DE COUPE RECOMMANDÉES

■ Profondeur de Passe / Avance par Dent

(mm)

Matière	Propriétés	ae	Conditions de stabilité	DC				
				ø20—ø28		ø32—ø50		
				ap	fz (mm/dent)	ap	fz (mm/dent)	
P	Acier doux	≤0.25DC	● ● ✱	≤14	0.13(0.10—0.15)	≤APMX	0.15(0.10—0.20)	
		0.25—0.5DC	● ● ✱	≤8	0.10(0.08—0.12)	≤28	0.13(0.10—0.15)	
		0.5—0.75DC	● ● ✱	≤6	0.10(0.08—0.12)	≤14	0.10(0.08—0.12)	
		DC(rainure)	● ● ✱	≤4	0.08(0.06—0.10)	≤4	0.08(0.06—0.10)	
	Acier carbone Acier allié	Dureté 180—280HB	≤0.25DC	● ● ✱	≤14	0.13(0.10—0.15)	≤APMX	0.15(0.10—0.20)
			0.25—0.5DC	● ● ✱	≤8	0.10(0.08—0.12)	≤28	0.13(0.10—0.15)
			0.5—0.75DC	● ● ✱	≤6	0.10(0.08—0.12)	≤14	0.10(0.08—0.12)
			DC(rainure)	● ● ✱	≤4	0.08(0.06—0.10)	≤4	0.08(0.06—0.10)
	Acier carbone Acier allié	Dureté 280—350HB	≤0.25DC	● ● ✱	≤14	0.13(0.10—0.15)	≤APMX	0.13(0.10—0.15)
			0.25—0.5DC	● ● ✱	≤8	0.10(0.08—0.12)	≤28	0.10(0.08—0.12)
			0.5—0.75DC	● ● ✱	≤6	0.10(0.08—0.12)	≤14	0.08(0.06—0.10)
			DC(rainure)	● ● ✱	≤4	0.08(0.06—0.10)	≤4	0.08(0.06—0.10)
	Acier pré-traité	Dureté 35—45HRC	≤0.25DC	● ● ✱	≤14	0.13(0.10—0.15)	≤APMX	0.13(0.10—0.15)
			0.25—0.5DC	● ● ✱	≤8	0.10(0.08—0.12)	≤28	0.10(0.08—0.12)
			0.5—0.75DC	● ● ✱	≤6	0.10(0.08—0.12)	≤14	0.08(0.06—0.10)
			DC(rainure)	● ● ✱	≤4	0.08(0.06—0.10)	≤4	0.08(0.06—0.10)
M	Acier inoxydable austénitique	≤0.25DC	● ● ✱	≤14	0.13(0.10—0.15)	≤APMX	0.15(0.10—0.20)	
			● ● ✱	≤14	0.10(0.08—0.12)	≤APMX	0.12(0.08—0.15)	
		0.25—0.5DC	● ● ✱	≤8	0.10(0.08—0.12)	≤28	0.12(0.08—0.15)	
			● ● ✱	≤8	0.08(0.06—0.10)	≤28	0.10(0.08—0.12)	
		0.5—0.75DC	● ● ✱	≤6	0.08(0.06—0.10)	≤14	0.10(0.08—0.12)	
			● ● ✱	≤6	0.07(0.06—0.08)	≤14	0.08(0.06—0.10)	
		DC(rainure)	● ● ✱	≤4	0.08(0.06—0.10)	≤4	0.08(0.06—0.10)	
			● ● ✱	≤4	0.07(0.06—0.08)	≤4	0.07(0.06—0.08)	
	Aciers inoxydables ferritiques et martensitiques	≤0.25DC	● ● ✱	≤14	0.13(0.10—0.15)	≤APMX	0.15(0.10—0.20)	
			● ● ✱	≤14	0.10(0.08—0.12)	≤APMX	0.12(0.08—0.15)	
		0.25—0.5DC	● ● ✱	≤8	0.10(0.08—0.12)	≤28	0.12(0.08—0.15)	
			● ● ✱	≤8	0.08(0.06—0.10)	≤28	0.10(0.08—0.12)	
		0.5—0.75DC	● ● ✱	≤6	0.08(0.06—0.10)	≤14	0.10(0.08—0.12)	
			● ● ✱	≤6	0.07(0.06—0.08)	≤14	0.08(0.06—0.10)	
		DC(rainure)	● ● ✱	≤4	0.08(0.06—0.10)	≤4	0.08(0.06—0.10)	
			● ● ✱	≤4	0.07(0.06—0.08)	≤4	0.07(0.06—0.08)	
	Acier inoxydable duplex	≤0.25DC	● ● ✱	≤14	0.13(0.10—0.15)	≤APMX	0.15(0.10—0.20)	
			● ● ✱	≤14	0.10(0.08—0.12)	≤APMX	0.12(0.08—0.15)	
		0.25—0.5DC	● ● ✱	≤8	0.10(0.08—0.12)	≤28	0.12(0.08—0.15)	
			● ● ✱	≤8	0.08(0.06—0.10)	≤28	0.10(0.08—0.12)	
		0.5—0.75DC	● ● ✱	≤6	0.08(0.06—0.10)	≤14	0.10(0.08—0.12)	
			● ● ✱	≤6	0.07(0.06—0.08)	≤14	0.08(0.06—0.10)	
		DC(rainure)	● ● ✱	≤4	0.08(0.06—0.10)	≤4	0.08(0.06—0.10)	
			● ● ✱	≤4	0.07(0.06—0.08)	≤4	0.07(0.06—0.08)	
Acier inoxydable à durcissement structural	≤0.25DC	● ● ✱	≤14	0.13(0.10—0.15)	≤APMX	0.13(0.10—0.15)		
		● ● ✱	≤14	0.10(0.08—0.12)	≤APMX	0.10(0.08—0.12)		
	0.25—0.5DC	● ● ✱	≤8	0.10(0.08—0.12)	≤28	0.10(0.08—0.12)		
		● ● ✱	≤8	0.08(0.06—0.10)	≤28	0.10(0.08—0.12)		
	0.5—0.75DC	● ● ✱	≤6	0.08(0.06—0.10)	≤14	0.08(0.06—0.10)		
		● ● ✱	≤6	0.07(0.06—0.08)	≤14	0.07(0.06—0.08)		
	DC(rainure)	● ● ✱	≤4	0.08(0.06—0.10)	≤4	0.08(0.06—0.10)		
		● ● ✱	≤4	0.07(0.06—0.08)	≤4	0.07(0.06—0.08)		

K

FRAISES À PLAQUETTES

Conditions de coupe (Guide) :

● : Coupe Stable ● : Coupe Générale ✖ : Coupe Instable

(mm)

Matière	Propriétés	ae	Conditions de stabilité	DC				
				ø20-ø28		ø32-ø50		
				ap	fz (mm/dent)	ap	fz (mm/dent)	
K	Fonte grise	≤0.25DC	● ●	≤14	0.13 (0.10-0.15)	≤APMX	0.15 (0.10-0.20)	
			● ● ✖	≤14	0.10 (0.08-0.12)	≤APMX	0.12 (0.08-0.15)	
		0.25-0.5DC	● ●	≤8	0.10 (0.08-0.12)	≤28	0.12 (0.08-0.15)	
			● ● ✖	≤8	0.08 (0.06-0.10)	≤28	0.10 (0.08-0.12)	
		0.5-0.75DC	● ●	≤6	0.10 (0.08-0.12)	≤14	0.10 (0.08-0.12)	
	● ● ✖		≤6	0.08 (0.06-0.10)	≤14	0.08 (0.06-0.10)		
	DC(rainure)	● ●	≤4	0.08 (0.06-0.10)	≤4	0.08 (0.06-0.10)		
		● ● ✖	≤4	0.07 (0.06-0.08)	≤4	0.07 (0.06-0.08)		
	Fonte ductile	-	≤0.25DC	● ●	≤14	0.13 (0.10-0.15)	≤APMX	0.15 (0.10-0.20)
				● ● ✖	≤14	0.10 (0.08-0.12)	≤APMX	0.13 (0.10-0.15)
0.25-0.5DC		● ●	≤8	0.10 (0.08-0.12)	≤28	0.13 (0.10-0.15)		
		● ● ✖	≤8	0.08 (0.06-0.10)	≤28	0.10 (0.08-0.12)		
0.5-0.75DC		● ●	≤6	0.10 (0.08-0.12)	≤14	0.10 (0.08-0.12)		
	● ● ✖	≤6	0.08 (0.06-0.10)	≤14	0.08 (0.06-0.10)			
DC(rainure)	● ●	≤4	0.08 (0.06-0.10)	≤4	0.08 (0.06-0.10)			
	● ● ✖	≤4	0.07 (0.06-0.08)	≤4	0.07 (0.06-0.08)			
N	Alliage aluminium	≤0.25DC	● ●	≤14	0.15 (0.10-0.20)	≤APMX	0.18 (0.10-0.25)	
			● ● ✖	≤14	0.13 (0.10-0.15)	≤APMX	0.15 (0.10-0.20)	
		0.25-0.5DC	● ●	≤8	0.13 (0.10-0.15)	≤28	0.15 (0.10-0.20)	
			● ● ✖	≤8	0.10 (0.08-0.12)	≤28	0.13 (0.10-0.15)	
		0.5-0.75DC	● ●	≤6	0.10 (0.08-0.12)	≤14	0.11 (0.06-0.15)	
	● ● ✖		≤6	0.08 (0.06-0.10)	≤14	0.11 (0.06-0.15)		
	DC(rainure)	● ●	≤4	0.08 (0.06-0.10)	≤4	0.11 (0.06-0.15)		
		● ● ✖	≤4	0.07 (0.06-0.08)	≤4	0.09 (0.06-0.12)		
	S	Alliage titane (Ti-6Al-4V etc.)	≤0.25DC	● ● ✖	≤14	0.12 (0.08-0.15)	≤APMX	0.12 (0.08-0.15)
				● ● ✖	≤8	0.10 (0.08-0.12)	≤28	0.10 (0.08-0.12)
0.25-0.5DC			● ● ✖	≤6	0.08 (0.06-0.10)	≤14	0.08 (0.06-0.10)	
			● ● ✖	≤4	0.08 (0.06-0.10)	≤4	0.08 (0.06-0.10)	
Alliage titane (Ti-5Al-5V-5Mo-3Cr etc.)		≤0.25DC	● ● ✖	≤14	0.10 (0.08-0.12)	≤APMX	0.10 (0.08-0.12)	
			● ● ✖	≤8	0.10 (0.08-0.12)	≤28	0.10 (0.08-0.12)	
		0.25-0.5DC	● ● ✖	≤6	0.08 (0.06-0.10)	≤14	0.08 (0.06-0.10)	
			● ● ✖	≤4	0.08 (0.06-0.10)	≤4	0.08 (0.06-0.10)	
Alliage réfractaire		≤0.25DC	● ● ✖	≤14	0.10 (0.08-0.12)	≤APMX	0.10 (0.08-0.12)	
			● ● ✖	≤8	0.10 (0.08-0.12)	≤28	0.10 (0.08-0.12)	
		0.25-0.5DC	● ● ✖	≤6	0.08 (0.06-0.10)	≤14	0.08 (0.06-0.10)	
			● ● ✖	≤4	0.08 (0.06-0.10)	≤4	0.08 (0.06-0.10)	

Remarque 1) En cas de vibration ou d'écaillage de plaquette, veuillez ajuster les conditions de coupe.

Remarque 2) Les vibrations sont plus probables dans les conditions suivantes :

- Avance par dent faible ou inférieure aux préconisations.
- Porte-à-faux important (queue longue, rallonge à visser, etc.).
- Faible raideur de machine, de pièce ou de bridage.
- Dans les angles en usinage de poches.

Remarque 3) Un pas plus grossier est recommandé pour un engagement radial (ae) supérieur à 0,5x DC.

Remarque 4) Il est recommandé d'usiner sous arrosage pour obtenir de meilleurs états de surface.

(La durée de vie de l'outil est plus courte qu'en usinage à sec)

Remarque 5) Lorsque les conditions de coupe sont supérieures à celles recommandées, ou lorsque les temps copeaux sont très longs, les vis de plaquettes peuvent se fissurer. Veuillez remplacer les vis de plaquettes.

K

FRAISES À PLAQUETTES

FRAISES À PLAQUETTES

■ Ramping / Interpolation Hélicoïdale

● Ramping

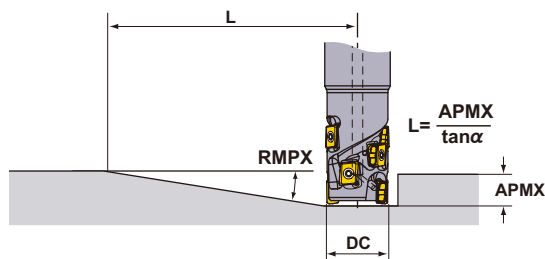

● Interpolation Hélicoïdale

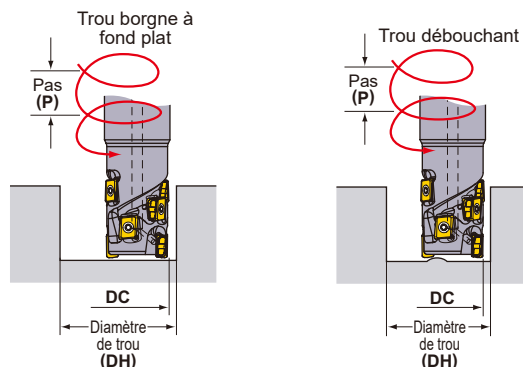

Se référer au tableau ci-dessous pour les conditions de coupe. Pour l'avance par dent et la vitesse de coupe, se référer aux conditions de coupe pour rainurage.

DC (mm)	RE (mm)	Ramping			Interpolation Hélicoïdale (Trou borgne à fond plat)				Interpolation Hélicoïdale (Trou débouchant)	
		RMPX	L (mm) *	DH max. (mm)	P max. (mm)	DH min. (mm)	P max. (mm)	DH min. (mm)	P max. (mm)	
20	0.2	1.35°	340	39.0	1.4	35.5	1.1	32.0	0.9	
	0.4	1.35°	340	38.6	1.4	35.5	1.1	32.0	0.9	
	0.8	1.35°	340	37.8	1.3	35.5	1.1	32.0	0.9	
	1.0	1.35°	340	37.4	1.3	35.5	1.1	32.0	0.9	
	1.2	1.35°	340	37.0	1.3	35.5	1.1	32.0	0.9	
22	0.2	1.16°	396	43.0	1.3	39.5	1.1	36.0	0.9	
	0.4	1.16°	396	42.6	1.3	39.5	1.1	36.0	0.9	
	0.8	1.16°	396	41.8	1.3	39.5	1.1	36.0	0.9	
	1.0	1.16°	396	41.4	1.2	39.5	1.1	36.0	0.9	
	1.2	1.16°	396	41.0	1.2	39.5	1.1	36.0	0.9	
25	0.2	0.97°	473	49.0	1.3	45.5	1.1	42.0	0.9	
	0.4	0.97°	473	48.6	1.3	45.5	1.1	42.0	0.9	
	0.8	0.97°	473	47.8	1.2	45.5	1.1	42.0	0.9	
	1.0	0.97°	473	47.4	1.2	45.5	1.1	42.0	0.9	
	1.2	0.97°	473	47.0	1.2	45.5	1.1	42.0	0.9	
28	0.2	0.84°	546	55.0	1.2	51.5	1.1	48.0	0.9	
	0.4	0.84°	546	54.6	1.2	51.5	1.1	48.0	0.9	
	0.8	0.84°	546	53.8	1.2	51.5	1.1	48.0	0.9	
	1.0	0.84°	546	53.4	1.2	51.5	1.1	48.0	0.9	
	1.2	0.84°	546	53.0	1.2	51.5	1.1	48.0	0.9	
32	0.2	0.71°	646	62.8	1.2	59.4	1.1	56.0	0.9	
	0.4	0.71°	646	62.4	1.2	59.4	1.1	56.0	0.9	
	0.8	0.71°	646	61.6	1.2	59.4	1.1	56.0	0.9	
	1.0	0.71°	646	61.2	1.1	59.4	1.1	56.0	0.9	
	1.2	0.71°	646	60.8	1.1	59.4	1.1	56.0	0.9	
35	0.2	0.63°	728	69.0	1.2	65.5	1.1	62.0	0.9	
	0.4	0.63°	728	68.6	1.2	65.5	1.1	62.0	0.9	
	0.8	0.63°	728	67.8	1.1	65.5	1.1	62.0	0.9	
	1.0	0.63°	728	67.4	1.1	65.5	1.1	62.0	0.9	
	1.2	0.63°	728	67.0	1.1	65.5	1.1	62.0	0.9	
40	0.2	0.54°	849	78.8	1.2	75.4	1.0	72.0	0.9	
	0.4	0.54°	849	78.4	1.1	75.4	1.0	72.0	0.9	
	0.8	0.54°	849	77.6	1.1	75.4	1.0	72.0	0.9	
	1.0	0.54°	849	77.2	1.1	75.4	1.0	72.0	0.9	
	1.2	0.54°	849	76.8	1.1	75.4	1.0	72.0	0.9	
50	0.2	0.42°	1092	98.8	1.1	95.4	1.0	92.0	1.0	
	0.4	0.42°	1092	98.4	1.1	95.4	1.0	92.0	1.0	
	0.8	0.42°	1092	97.6	1.1	95.4	1.0	92.0	1.0	
	1.0	0.42°	1092	97.2	1.1	95.4	1.0	92.0	1.0	
	1.2	0.42°	1092	96.8	1.1	95.4	1.0	92.0	1.0	
1.6	0.42°	1092	96.0	1.1	95.4	1.0	92.0	1.0		

Remarque 1) L'usinage en ramping peut créer des copeaux longs dans les matières ductiles.

* Distance jusqu'à ce qu'une profondeur de coupe maximale de 8 mm soit atteinte à l'angle de ramping maximal $L = 8/\tan(\alpha)$.

K

FRAISES À PLAQUETTES

Tréflage et perçage

Voir les tableaux de droite pour les engagements et profondeurs de perçage. Pour l'avance par dent et la vitesse de coupe, veuillez utiliser les conditions de coupe pour le rainurage.

● Tréflage

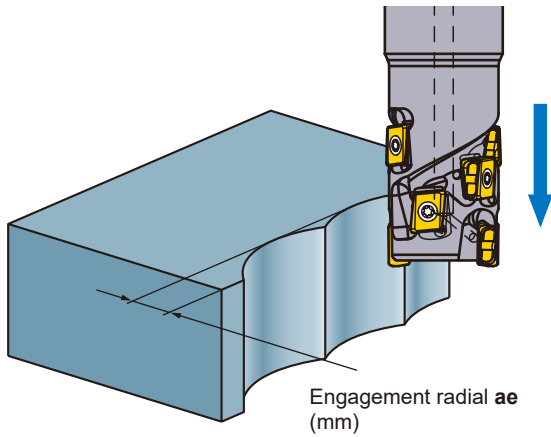

DC (mm)	ae max. (mm)
20	3.9
22	4.0
25	4.0
28	4.0
32	4.0
35	4.0
40	4.0
50	4.0

Remarque 1) Un cycle de déburrage n'est pas nécessaire.

● Perçage

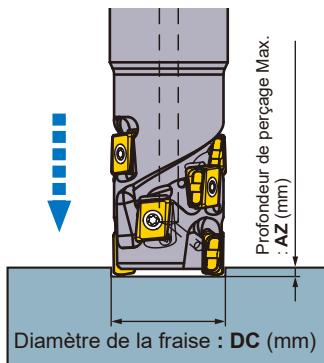

DC (mm)	AZ max. (mm)
20	0.3
22	0.3
25	0.3
28	0.3
32	0.3
35	0.3
40	0.3
50	0.3

Remarque 1) Attention aux projections de copeaux.

Remarque 2) Évacuez les copeaux à l'aide d'air comprimé (ou de liquide d'arrosage lors de l'usinage d'un alliage d'aluminium).

FRAISES À PLAQUETTES

FRAISES À SURFACER-DRESSER



VPX300

NEW

SÉRIE LONGUE

- P M K N S H

K

FRAISES À PLAQUETTES

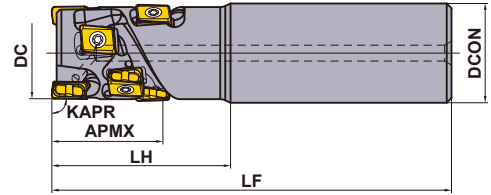

Outil à droite uniquement.

ATTACHEMENT CYLINDRIQUE

Avec trou de lubrification

DC (mm)	Référence	Stock	Nbre goujures	Total	Dimensions (mm)			APMX (mm)	RMPX	WT ^{*2} (kg)	Type Plaque ^{*1}
		R			DCON	LF	LH				
40	VPX300R402SA32S02104	●	2	4	32	125	45	21	1.06°	0.78	LOGU12
40	VPX300R402SA32S03106	●	2	6	32	130	50	31	1.06°	0.79	LOGU12
40	VPX300R402SA32S04208	●	2	8	32	140	60	42	1.06°	0.84	LOGU12

*1 Le rayon RE doit être inférieur ou égal à 0,8 mm, sauf pour la rangée de plaquettes en bout de fraise.

Les plaquettes RE 0,2 mm et 0,4 mm peuvent également être utilisées en bout de fraise.

*2 WT : Poids de l'outil

PIÈCES DÉTACHÉES

DC (mm)	Référence porte-outil	* (Standard Japan)		
		Vis de serrage	Clé	Anti-grippant
40	VPX300R40	TPS40F1	TIP15W	MK1KS

* Couple de serrage (N • m) : TPS40F1 = 3,5

● : Article stocké. ★ : Article standard Japon.

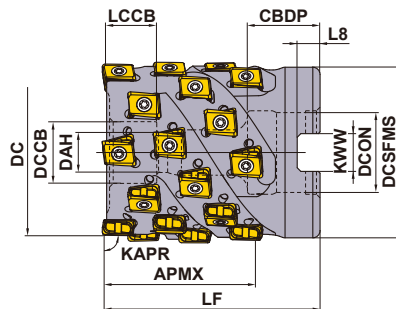

Outil à droite uniquement.

Référence	APMX	Vis d'attachement	Géométrie
VPX300-040A02A031	31	HSC08040	
VPX300-040A02A042	42	HSC08050	
VPX300-050A03A031	31	HSC10040	
VPX300-050A03A042	42	HSC10050	
VPX300-050A03A052	52	HSC10060	
VPX300-063A04A042	42	HSC12050	
VPX300-063A04A052	52	HSC12060	
VPX300-080A05A052	52	HSC12060	
VPX300-080A05A063	63	HSC12070	
VPX300R08005CA052	52	HSC16055	
VPX300R08005CA063	63	HSC16065	

FRAISE à ALÉSAGE

KAPR: 90°

GAMP: -6° GAMF: -22.5°

Avec trou de lubrification

DCON = Taille mm

DC (mm)	Référence	Stock R	Nbre goujures	Total	Dimensions (mm)		WT *2 (kg)	APMX (mm)	RMPX	*1 Type Plaquette
					LF	DCON				
40	VPX300-040A02A031R06	●	2	6	50	16	0.26	31	1.06°	LOGU12
40	VPX300-040A02A042R08	●	2	8	60	16	0.31	42	1.06°	LOGU12
50	VPX300-050A03A031R09	●	3	9	55	22	0.47	31	0.79°	LOGU12
50	VPX300-050A03A042R12	●	3	12	65	22	0.55	42	0.79°	LOGU12
50	VPX300-050A03A052R15	●	3	15	75	22	0.63	52	0.79°	LOGU12
63	VPX300-063A04A042R16	★	4	16	65	27	0.92	42	0.6°	LOGU12
63	VPX300-063A04A052R20	★	4	20	75	27	1.06	52	0.6°	LOGU12
80	VPX300-080A05A052R25	★	5	25	75	27	1.94	52	0.45°	LOGU12
80	VPX300-080A05A063R30	★	5	30	85	27	2.20	63	0.45°	LOGU12

DCON = taille en pouces (in)

DC (mm)	Référence	Stock R	Nbre goujures	Total	Dimensions (mm)		WT (kg)	APMX (mm)	RMPX	*1 Type Plaquette
					LF	DCON				
80	VPX300R08005CA05225	★	5	25	75	31.75	1.81	52	0.45°	LOGU12
80	VPX300R08005CA06330	★	5	30	85	31.75	2.06	63	0.45°	LOGU12

*1 Le rayon RE doit être inférieur ou égal à 0,8 mm, sauf pour la rangée de plaquettes en bout de fraise.

Les plaquettes RE 0,2 mm et 0,4 mm peuvent également être utilisées en bout de fraise.

*2 WT : Poids de l'outil

DIMENSIONS DE MONTAGE





DC (mm)	Référence	Dimensions (mm)							
		DCON	CBDP	DAH	DCCB	LCCB	DCSFMS	KWW	L8
40	VPX300-040A02A031R06	16	18	9	14	8.4	37	8.4	5.6
40	VPX300-040A02A042R08	16	18	9	14	8.4	37	8.4	5.6
50	VPX300-050A03A031R09	22	20	11	17	12.4	47	10.4	6.3
50	VPX300-050A03A042R12	22	20	11	17	12.4	47	10.4	6.3
50	VPX300-050A03A052R15	22	20	11	17	12.4	47	10.4	6.3
63	VPX300-063A04A042R16	27	23	13	20	12.4	76	12.4	7.0
63	VPX300-063A04A052R20	27	23	13	20	12.4	76	12.4	7.0
80	VPX300-080A05A052R25	27	23	13	20	12.4	76	12.4	7.0
80	VPX300-080A05A063R30	27	23	13	20	12.4	76	12.4	7.0
80	VPX300R08005CA05225	31.75	32	17	26	17.4	76	12.7	8.0
80	VPX300R08005CA06330	31.75	32	17	26	17.4	76	12.7	8.0

FRAISES À PLAQUETTES

PLAQUETTES

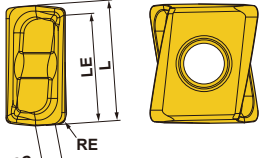
FRAISES À PLAQUETTES

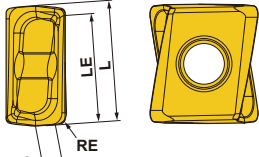
K

Matière	P	Acier											Conditions de coupe (Guide):						
	M	Acier Inoxydable											● : Coupe Stable ● : Coupe Générale ✦ : Coupe Instable						
	K	Fonte																	
N	Non ferreux											Honing :							
S	Alliage réfractaire, Alliage titane											E : Ronde F : Affûtée							
H	Acier trempé																		
Forme	Référence	Classe	Honing	Revêtu							Carbure	Dimensions (mm)					Géométrie		
				MC5020	MP6120	MP6130	MP7130	MP9120	MP9130	VP15TF	TF15	L	RE	LE	S	BS			
Faible effort de coupe Brise-copeaux L	LOGU1207020PNER-L	G	E	★	★	★	★	★	★	★	★			12.4	0.2	11.3	7.0	3.0	  Outil représenté à droite.
	LOGU1207040PNER-L	G	E	●	●	●	●	●	●	●	★			12.4	0.4	11.3	7.0	2.8	
	LOGU1207080PNER-L	G	E	●	●	●	●	●	●	●	★			12.4	0.8	11.3	7.0	2.6	
	LOGU1207100PNER-L	G	E	★	★	★	★	★	★	★	★			12.4	1.0	11.3	7.0	2.5	
	LOGU1207120PNER-L	G	E	●	●	●	●	●	●	●	★			12.4	1.2	11.3	7.0	2.4	
	LOGU1207160PNER-L	G	E	●	●	●	●	●	●	●	★			12.4	1.6	11.3	7.0	1.8	
	LOGU1207200PNER-L	G	E	●	●	●	●	●	●	●	★			12.4	2.0	11.3	7.0	1.4	
	LOGU1207240PNER-L	G	E	●	●	●	●	●	●	●	★			12.4	2.4	11.3	7.0	1.2	
	LOGU1207300PNER-L	G	E	★	★	★	★	★	★	★	★			12.4	3.0	11.3	7.0	0.6	
	LOGU1207320PNER-L	G	E	●	●	●	●	●	●	●	★			12.4	3.2	11.3	7.0	0.4	
	LOGU1207020PNFR-L	G	F									★		12.4	0.2	11.3	7.0	3.0	
	LOGU1207040PNFR-L	G	F									●		12.4	0.4	11.3	7.0	2.8	
	LOGU1207080PNFR-L	G	F									●		12.4	0.8	11.3	7.0	2.6	
	LOGU1207100PNFR-L	G	F									★		12.4	1.0	11.3	7.0	2.5	
	LOGU1207120PNFR-L	G	F									●		12.4	1.2	11.3	7.0	2.4	
	LOGU1207160PNFR-L	G	F									●		12.4	1.6	11.3	7.0	1.8	
	LOGU1207200PNFR-L	G	F									●		12.4	2.0	11.3	7.0	1.4	
	LOGU1207240PNFR-L	G	F									●		12.4	2.4	11.3	7.0	1.2	
	LOGU1207300PNFR-L	G	F									★		12.4	3.0	11.3	7.0	0.6	
	LOGU1207320PNFR-L	G	F									●		12.4	3.2	11.3	7.0	0.4	
Usage général Brise-copeaux M	LOGU1207020PNER-M	G	E	★	★	★	★	★	★	★	★			12.4	0.2	11.3	7.0	3.0	  Outil représenté à droite.
	LOGU1207040PNER-M	G	E	●	●	●	●	●	●	●	★			12.4	0.4	11.3	7.0	2.8	
	LOGU1207080PNER-M	G	E	●	●	●	●	●	●	●	★			12.4	0.8	11.3	7.0	2.4	
	LOGU1207100PNER-M	G	E	★	★	★	★	★	★	★	★			12.4	1.0	11.3	7.0	2.3	
	LOGU1207120PNER-M	G	E	●	●	●	●	●	●	●	★			12.4	1.2	11.3	7.0	2.1	
	LOGU1207160PNER-M	G	E	●	●	●	●	●	●	●	★			12.4	1.6	11.3	7.0	1.7	
	LOGU1207200PNER-M	G	E	●	●	●	●	●	●	●	★			12.4	2.0	11.3	7.0	1.4	
	LOGU1207240PNER-M	G	E	●	●	●	●	●	●	●	★			12.4	2.4	11.3	7.0	1.0	
	LOGU1207300PNER-M	G	E	★	★	★	★	★	★	★	★			12.4	3.0	11.3	7.0	0.5	
	LOGU1207320PNER-M	G	E	●	●	●	●	●	●	●	★			12.4	3.2	11.3	7.0	0.3	
	LOGU1207020PNFR-M	G	F									★		12.4	0.2	11.3	7.0	3.0	
	LOGU1207040PNFR-M	G	F									●		12.4	0.4	11.3	7.0	2.8	
	LOGU1207080PNFR-M	G	F									●		12.4	0.8	11.3	7.0	2.4	
	LOGU1207100PNFR-M	G	F									★		12.4	1.0	11.3	7.0	2.3	
	LOGU1207120PNFR-M	G	F									●		12.4	1.2	11.3	7.0	2.1	
	LOGU1207160PNFR-M	G	F									●		12.4	1.6	11.3	7.0	1.7	
	LOGU1207200PNFR-M	G	F									●		12.4	2.0	11.3	7.0	1.4	
	LOGU1207240PNFR-M	G	F									●		12.4	2.4	11.3	7.0	1.0	
	LOGU1207300PNFR-M	G	F									★		12.4	3.0	11.3	7.0	0.5	
	LOGU1207320PNFR-M	G	F									●		12.4	3.2	11.3	7.0	0.3	

● ★ = NEW

● : Article stocké. ★ : Article standard Japon.
(10 plaquettes par boîte)

Conditions de coupe (Guide) :

● : Coupe Stable ● : Coupe Générale ✘ : Coupe Instable

RECOMMANDATIONS BRISE-COPEAUX

■ Sélection des brise-copeaux

Matière	Propriétés	Conditions de stabilité	Brise-Copeaux		Nuance		
			1ère préconisation	2de préconisation	1ère préconisation	2de préconisation	
P	Acier doux	Dureté ≤180HB	● ●	L	M	MP6120	VP15TF
			✘	M	L	MP6130	—
	Acier carbone Alliage acier Acier outil	Dureté 180-350HB ≤350HB (recuit)	● ●	L	M	MP6120	VP15TF
			● ●	M	L	MP6120	VP15TF
			✘	M	L	MP6130	—
	Acier pré-traité	Dureté 35–45HRC	● ●	M	L	MP6120	VP15TF
✘			M	L	MP6130	—	
M	Acier inoxydable austénitique	Dureté ≤280HB	● ●	L	M	MP7130	VP15TF
			✘	M	L	MP7130	—
		Dureté >200HB	● ●	L	M	MP7130	VP15TF
			✘	M	L	MP7130	—
	Acier inoxydable duplex	Dureté ≤280HB	● ●	L	M	MP7130	VP15TF
			✘	M	L	MP7130	—
	Aciers inoxydables ferritiques et martensitiques	—	● ●	L	M	MP7130	VP15TF
			✘	M	L	MP7130	—
	Acier inoxydable à durcissement structural	Dureté <450HB	● ●	L	M	MP7130	VP15TF
			✘	M	L	MP7130	—
K	Fonte grise	Résistance à la traction ≤350MPa	● ●	M	L	MC5020	VP15TF
			✘	M	L	VP15TF	—
	Fonte ductile	Résistance à la traction ≤800MPa	● ●	M	L	MC5020	VP15TF
			✘	M	L	VP15TF	—
N	Alliage aluminium	Content Si <5%	● ●	L	M	TF15	—
			✘	M	L	TF15	—
S	Alliage titane (Ti-6Al-4V, etc.)	—	● ●	L	M	MP9120	VP15TF
			✘	M	L	MP9130	—
	Alliage titane (Ti-5Al-5V-5Mo-3Cr, etc.)	—	● ●	L	M	MP9120	VP15TF
			✘	M	L	MP9130	—
	Alliage réfractaire	—	● ●	M	L	MP9120	VP15TF
			✘	M	L	MP9130	—
H	Acier trempé	Dureté 40–55HRC	● ● ✘	M	—	VP15TF	—

K

FRAISES À PLAQUETTES

CONDITIONS DE COUPE RECOMMANDÉES

Vitesse de coupe

(mm)

Matière	Propriétés	Conditions de stabilité	Nuance	ae				Lubrification	
				≤0.25DC	0.25–0.5DC	0.5–0.75DC	DC(rainure)		
				Vc (m/min)					
P	Acier doux Dureté ≤180HB	● ●	MP6120,VP15TF	140(100–190)	130(90–180)	100(70–120)	100(70–120)	Sans, Avec	
		● ●	MP6130	140(100–190)	130(90–180)	100(70–120)	100(70–120)	Sans, Avec	
	Acier carbone Alliage acier Dureté 180–350HB	● ●	MP6120,VP15TF	120(90–140)	110(80–130)	100(70–120)	100(70–120)	Sans, Avec	
		● ●	MP6130	120(90–140)	110(80–130)	100(70–120)	100(70–120)	Sans, Avec	
	Acier pré-traité Dureté 180–350HB	● ●	MP6120,VP15TF	100(80–120)	90(70–110)	80(60–100)	80(60–100)	Sans, Avec	
		● ●	MP6130	100(80–120)	90(70–110)	80(60–100)	80(60–100)	Sans, Avec	
M	Acier inoxydable austénitique Dureté ≤200HB	● ●	MP7130,VP15TF	120(100–150)	110(90–140)	90(70–120)	90(70–120)	Sans, Avec	
		● ●	MP7130	120(100–150)	110(90–140)	90(70–120)	90(70–120)	Sans, Avec	
		● ●	MP7130,VP15TF	100(80–130)	90(70–120)	70(50–100)	70(50–100)	Sans, Avec	
		● ●	MP7130	100(80–130)	90(70–120)	70(50–100)	70(50–100)	Sans, Avec	
	Aciers inoxydables ferritiques et martensitiques	–	● ●	MP7130,VP15TF	120(100–150)	110(90–140)	90(70–120)	90(70–120)	Sans, Avec
		–	● ●	MP7130	120(100–150)	110(90–140)	90(70–120)	90(70–120)	Sans, Avec
	Acier inoxydable duplex Dureté ≤280HB	–	● ●	MP7130,VP15TF	100(80–130)	90(70–120)	70(50–100)	70(50–100)	Sans, Avec
		–	● ●	MP7130	100(80–130)	90(70–120)	70(50–100)	70(50–100)	Sans, Avec
	Acier inoxydable à durcissement structural Dureté <450HB	–	● ●	MP7130,VP15TF	90(70–120)	80(60–110)	60(40–90)	60(40–90)	Sans, Avec
		–	● ●	MP7130	90(70–120)	80(60–110)	60(40–90)	60(40–90)	Sans, Avec
	K	Fonte grise Résistance à la traction ≤350MPa	● ●	MC5020	180(160–220)	170(150–210)	150(130–190)	150(130–190)	Sans, Avec
			● ●	VP15TF	130(100–150)	120(90–140)	100(80–120)	100(80–120)	Sans, Avec
Fonte ductile Résistance à la traction ≤800MPa		● ●	MC5020	160(140–180)	150(130–170)	130(110–150)	130(110–150)	Sans, Avec	
		● ●	VP15TF	110(80–140)	100(70–130)	80(60–120)	80(60–120)	Sans, Avec	
N	Alliage aluminium Content Si <5%	● ●	TF15	600(400–1000)	600(400–1000)	600(400–1000)	600(400–1000)	Sans, Avec	
S	Alliage titane (Ti-6Al-4V etc.)	● ●	MP9120	50(40–70)	50(40–70)	50(40–70)	50(40–70)	Avec	
		● ●	VP15TF	50(40–70)	50(40–70)	50(40–70)	50(40–70)	Avec	
		● ●	MP9130	50(40–70)	50(40–70)	50(40–70)	50(40–70)	Avec	
	Alliage titane (Ti-6Al-5V-5Mo-3Cr etc.)	–	● ●	MP9120	30(20–40)	30(20–40)	30(20–40)	30(20–40)	Avec
		–	● ●	VP15TF	30(20–40)	30(20–40)	30(20–40)	30(20–40)	Avec
		–	● ●	MP9130	30(20–40)	30(20–40)	30(20–40)	30(20–40)	Avec
	Alliage réfractaire	–	● ●	MP9120	40(30–60)	40(30–60)	40(30–60)	40(30–60)	Avec
		–	● ●	VP15TF	40(30–60)	40(30–60)	40(30–60)	40(30–60)	Avec
		–	● ●	MP9130	40(30–60)	40(30–60)	40(30–60)	40(30–60)	Avec

Remarque 1) En cas de vibration ou d'écaillage de plaquette, veuillez ajuster les conditions de coupe.

Remarque 2) Les vibrations sont plus probables dans les conditions suivantes :

- Avance par dent faible ou inférieure aux préconisations.
- Porte-à-faux important (queue longue, rallonge à visser, etc.).
- Faible raideur de machine, de pièce ou de bridage.
- Dans les angles en usinage de poches.

Remarque 3) Un pas plus grossier est recommandé pour un engagement radial (ae) supérieur à 0,5x DC.

Remarque 4) Il est recommandé d'usiner sous arrosage pour obtenir de meilleurs états de surface.

(La durée de vie de l'outil est plus courte qu'en usinage à sec)

Remarque 5) Lorsque les conditions de coupe sont supérieures à celles recommandées, ou lorsque les temps copeaux sont très longs, les vis de plaquettes peuvent se fissurer. Veuillez remplacer les vis de plaquettes.

K

FRAISES À PLAQUETTES

Conditions de coupe (Guide) :

● : Coupe Stable ● : Coupe Générale ✖ : Coupe Instable

■ Profondeur de Passe / Avance par Dent

(mm)

Matière	Propriétés	ae	Conditions de stabilité	DC			
				ø40		ø50-ø80	
				ap	fz (mm/dent)	ap	fz (mm/dent)
P	Acier doux Dureté ≤180HB	≤0.25DC	● ● ✖	≤APMX	0.15 (0.10-0.20)	≤APMX	0.18 (0.10-0.25)
		0.25-0.5DC	● ● ✖	≤APMX	0.13 (0.10-0.15)	≤31	0.15 (0.10-0.20)
		0.5-0.75DC	● ● ✖	≤21	0.10 (0.08-0.12)	≤21	0.13 (0.10-0.15)
		DC(rainure)	● ● ✖	≤5	0.08 (0.06-0.10)	≤5	0.10 (0.08-0.12)
	Acier carbone Acier allié Dureté 180-280HB	≤0.25DC	● ● ✖	≤APMX	0.15 (0.10-0.20)	≤APMX	0.18 (0.10-0.25)
		0.25-0.5DC	● ● ✖	≤APMX	0.13 (0.10-0.15)	≤31	0.15 (0.10-0.20)
		0.5-0.75DC	● ● ✖	≤21	0.10 (0.08-0.12)	≤21	0.13 (0.10-0.15)
		DC(rainure)	● ● ✖	≤5	0.08 (0.06-0.10)	≤5	0.10 (0.08-0.12)
	Acier carbone Acier allié Dureté 280-350HB	≤0.25DC	● ● ✖	≤APMX	0.13 (0.10-0.15)	≤APMX	0.15 (0.10-0.20)
		0.25-0.5DC	● ● ✖	≤APMX	0.10 (0.08-0.12)	≤31	0.13 (0.10-0.15)
		0.5-0.75DC	● ● ✖	≤21	0.08 (0.06-0.10)	≤21	0.10 (0.08-0.12)
		DC(rainure)	● ● ✖	≤5	0.08 (0.06-0.10)	≤5	0.08 (0.06-0.10)
	Acier pré-traité Dureté 35-45HRC	≤0.25DC	● ● ✖	≤APMX	0.13 (0.10-0.15)	≤APMX	0.15 (0.10-0.20)
		0.25-0.5DC	● ● ✖	≤APMX	0.10 (0.08-0.12)	≤31	0.13 (0.10-0.15)
		0.5-0.75DC	● ● ✖	≤21	0.08 (0.06-0.10)	≤21	0.10 (0.08-0.12)
		DC(rainure)	● ● ✖	≤5	0.08 (0.06-0.10)	≤5	0.08 (0.06-0.10)
M	Acier inoxydable austénitique -	≤0.25DC	● ● ✖	≤APMX	0.15 (0.10-0.20)	≤APMX	0.15 (0.10-0.20)
			● ● ✖	≤APMX	0.12 (0.08-0.15)	≤APMX	0.12 (0.08-0.15)
		0.25-0.5DC	● ● ✖	≤APMX	0.12 (0.08-0.15)	≤31	0.12 (0.08-0.15)
			● ● ✖	≤APMX	0.10 (0.08-0.12)	≤31	0.10 (0.08-0.12)
		0.5-0.75DC	● ● ✖	≤21	0.10 (0.08-0.12)	≤21	0.10 (0.08-0.12)
			● ● ✖	≤21	0.08 (0.06-0.10)	≤21	0.08 (0.06-0.10)
		DC(rainure)	● ● ✖	≤5	0.08 (0.06-0.10)	≤5	0.08 (0.06-0.10)
			● ● ✖	≤5	0.07 (0.06-0.08)	≤5	0.07 (0.06-0.08)
	Aciers inoxydables ferritiques et martensitiques Dureté ≤200HB	≤0.25DC	● ● ✖	≤APMX	0.15 (0.10-0.20)	≤APMX	0.15 (0.10-0.20)
			● ● ✖	≤APMX	0.12 (0.08-0.15)	≤APMX	0.12 (0.08-0.15)
		0.25-0.5DC	● ● ✖	≤APMX	0.12 (0.08-0.15)	≤31	0.12 (0.08-0.15)
			● ● ✖	≤APMX	0.10 (0.08-0.12)	≤31	0.10 (0.08-0.12)
		0.5-0.75DC	● ● ✖	≤21	0.10 (0.08-0.12)	≤21	0.10 (0.08-0.12)
			● ● ✖	≤21	0.08 (0.06-0.10)	≤21	0.08 (0.05-0.10)
		DC(rainure)	● ● ✖	≤5	0.08 (0.06-0.10)	≤5	0.08 (0.05-0.10)
			● ● ✖	≤5	0.07 (0.06-0.08)	≤5	0.07 (0.05-0.08)
	Acier inoxydable duplex Dureté ≤280HB	≤0.25DC	● ● ✖	≤APMX	0.15 (0.10-0.20)	≤APMX	0.15 (0.10-0.20)
			● ● ✖	≤APMX	0.12 (0.08-0.15)	≤APMX	0.12 (0.08-0.15)
		0.25-0.5DC	● ● ✖	≤APMX	0.12 (0.08-0.15)	≤31	0.12 (0.08-0.15)
			● ● ✖	≤APMX	0.10 (0.08-0.12)	≤31	0.10 (0.08-0.12)
		0.5-0.75DC	● ● ✖	≤21	0.10 (0.08-0.12)	≤21	0.10 (0.08-0.12)
			● ● ✖	≤21	0.08 (0.06-0.10)	≤21	0.08 (0.06-0.10)
		DC(rainure)	● ● ✖	≤5	0.08 (0.06-0.10)	≤5	0.08 (0.06-0.10)
			● ● ✖	≤5	0.07 (0.06-0.08)	≤5	0.07 (0.06-0.08)
Acier inoxydable à durcissement structural Dureté <450HB	≤0.25DC	● ● ✖	≤APMX	0.13 (0.10-0.15)	≤APMX	0.13 (0.10-0.15)	
		● ● ✖	≤APMX	0.10 (0.08-0.12)	≤APMX	0.10 (0.08-0.12)	
	0.25-0.5DC	● ● ✖	≤APMX	0.10 (0.08-0.12)	≤31	0.10 (0.08-0.12)	
		● ● ✖	≤APMX	0.10 (0.08-0.12)	≤31	0.10 (0.08-0.12)	
	0.5-0.75DC	● ● ✖	≤21	0.08 (0.06-0.10)	≤21	0.08 (0.05-0.10)	
		● ● ✖	≤21	0.07 (0.06-0.08)	≤21	0.07 (0.05-0.08)	
	DC(rainure)	● ● ✖	≤5	0.08 (0.06-0.10)	≤5	0.08 (0.05-0.10)	
		● ● ✖	≤5	0.07 (0.06-0.08)	≤5	0.07 (0.06-0.08)	

K

FRAISES À PLAQUETTES

CONDITIONS DE COUPE RECOMMANDÉES

■ Profondeur de Passe / Avance par Dent

(mm)

Matière	Propriétés	ae	Conditions de stabilité	DC					
				ø40		ø50-ø80			
				ap	fz (mm/dent)	ap	fz (mm/dent)		
K	Fonte grise Résistance à la traction ≤350MPa	≤0.25DC	● ●	≤APMX	0.15 (0.10-0.20)	≤APMX	0.18 (0.10-0.25)		
			● ✖	≤APMX	0.12 (0.08-0.15)	≤APMX	0.15 (0.10-0.20)		
		0.25-0.5DC	● ●	≤APMX	0.12 (0.08-0.15)	≤31	0.15 (0.10-0.20)		
			● ✖	≤APMX	0.10 (0.08-0.12)	≤31	0.13 (0.10-0.15)		
		0.5-0.75DC	● ●	≤21	0.10 (0.08-0.12)	≤21	0.13 (0.10-0.15)		
			● ✖	≤21	0.08 (0.06-0.10)	≤21	0.10 (0.08-0.12)		
		DC(rainure)	● ●	≤5	0.08 (0.06-0.10)	≤5	0.12 (0.08-0.15)		
			● ✖	≤5	0.07 (0.06-0.08)	≤5	0.08 (0.06-0.10)		
		Fonte ductile	-	≤0.25DC	● ●	≤APMX	0.15 (0.10-0.20)	≤APMX	0.15 (0.10-0.20)
					● ✖	≤APMX	0.13 (0.10-0.15)	≤APMX	0.13 (0.10-0.15)
0.25-0.5DC	● ●			≤APMX	0.13 (0.10-0.15)	≤31	0.13 (0.10-0.15)		
	● ✖			≤APMX	0.10 (0.08-0.12)	≤31	0.10 (0.08-0.12)		
0.5-0.75DC	● ●			≤21	0.10 (0.08-0.12)	≤21	0.10 (0.08-0.12)		
	● ✖			≤21	0.08 (0.06-0.10)	≤21	0.08 (0.06-0.10)		
DC(rainure)	● ●			≤5	0.08 (0.06-0.10)	≤5	0.08 (0.06-0.10)		
	● ✖			≤5	0.07 (0.06-0.08)	≤5	0.07 (0.06-0.08)		
N	Alliage aluminium Content Si <5%			≤0.25DC	● ●	≤APMX	0.18 (0.10-0.25)	≤APMX	0.18 (0.10-0.25)
					● ✖	≤APMX	0.15 (0.10-0.20)	≤APMX	0.15 (0.10-0.20)
		0.25-0.5DC	● ●	≤APMX	0.15 (0.10-0.20)	≤31	0.15 (0.10-0.20)		
			● ✖	≤APMX	0.13 (0.10-0.15)	≤31	0.13 (0.10-0.15)		
		0.5-0.75DC	● ●	≤21	0.11 (0.06-0.15)	≤21	0.12 (0.08-0.15)		
			● ✖	≤21	0.11 (0.06-0.15)	≤21	0.12 (0.08-0.15)		
		DC(rainure)	● ●	≤5	0.11 (0.06-0.15)	≤5	0.12 (0.08-0.15)		
			● ✖	≤5	0.09 (0.06-0.12)	≤5	0.10 (0.08-0.12)		
		S	Alliage titane (Ti-6Al-4V etc.)	≤0.25DC	● ● ✖	≤APMX	0.12 (0.08-0.15)	≤APMX	0.12 (0.08-0.15)
				0.25-0.5DC	● ● ✖	≤APMX	0.10 (0.08-0.12)	≤31	0.10 (0.08-0.12)
0.5-0.75DC	● ● ✖			≤21	0.08 (0.06-0.10)	≤21	0.08 (0.06-0.10)		
DC(rainure)	● ● ✖			≤5	0.08 (0.06-0.10)	≤5	0.08 (0.06-0.10)		
Alliage titane (Ti-5Al-5V-5Mo-3Cr etc.)	≤0.25DC		● ● ✖	≤APMX	0.10 (0.08-0.12)	≤APMX	0.10 (0.08-0.12)		
	0.25-0.5DC		● ● ✖	≤APMX	0.10 (0.08-0.12)	≤31	0.10 (0.08-0.12)		
	0.5-0.75DC		● ● ✖	≤21	0.08 (0.06-0.10)	≤21	0.08 (0.06-0.10)		
	DC(rainure)		● ● ✖	≤5	0.08 (0.06-0.10)	≤5	0.08 (0.06-0.10)		
Alliage réfractaire	≤0.25DC		● ● ✖	≤APMX	0.10 (0.08-0.12)	≤APMX	0.10 (0.08-0.12)		
	0.25-0.5DC		● ● ✖	≤APMX	0.10 (0.08-0.12)	≤31	0.10 (0.08-0.12)		
	0.5-0.75DC		● ● ✖	≤21	0.08 (0.06-0.10)	≤21	0.08 (0.06-0.10)		
	DC(rainure)		● ● ✖	≤5	0.08 (0.06-0.10)	≤5	0.08 (0.06-0.10)		

Remarque 1) En cas de vibration ou d'écaillage de plaquette, veuillez ajuster les conditions de coupe.

Remarque 2) Les vibrations sont plus probables dans les conditions suivantes :

- Avance par dent faible ou inférieure aux préconisations.
- Porte-à-faux important (queue longue, rallonge à visser, etc.).
- Faible raideur de machine, de pièce ou de bridage.
- Dans les angles en usinage de poches.

Remarque 3) Un pas plus grossier est recommandé pour un engagement radial (ae) supérieur à 0,5x DC.

Remarque 4) Il est recommandé d'usiner sous arrosage pour obtenir de meilleurs états de surface.

(La durée de vie de l'outil est plus courte qu'en usinage à sec)

Remarque 5) Lorsque les conditions de coupe sont supérieures à celles recommandées, ou lorsque les temps copeaux sont très longs, les vis de plaquettes peuvent se fissurer. Veuillez remplacer les vis de plaquettes.

■ Ramping / Interpolation Hélicoïdale

● Ramping

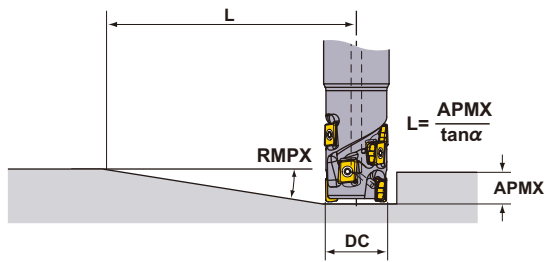

● Interpolation Hélicoïdale

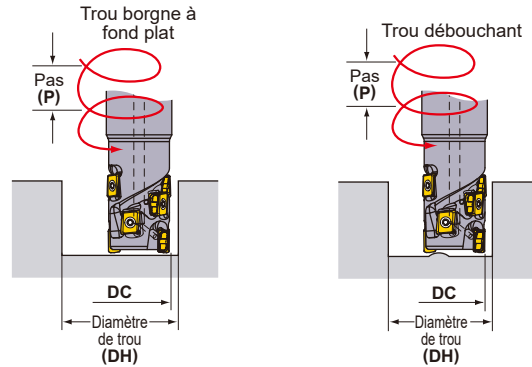

Se référer au tableau ci-dessous pour les conditions de coupe. Pour l'avance par dent et la vitesse de coupe, se référer aux conditions de coupe pour rainurage.

DC (mm)	RE (mm)	Ramping		Interpolation Hélicoïdale (Trou borgne à fond plat)				Interpolation Hélicoïdale (Trou débouchant)	
		RMPX	L (mm) *	DH max. (mm)	P max. (mm)	DH min. (mm)	P max. (mm)	DH min. (mm)	P max. (mm)
40	0.2	1.06°	595	78.8	2.3	72.7	1.9	66.5	1.5
	0.4	1.06°	595	78.4	2.2	72.7	1.9	66.5	1.5
	0.8	1.06°	595	77.6	2.2	72.7	1.9	66.5	1.5
	1.0	1.06°	595	77.2	2.2	72.7	1.9	66.5	1.5
	1.2	1.06°	595	76.8	2.1	72.7	1.9	66.5	1.5
	1.6	1.06°	595	76.0	2.1	72.7	1.9	66.5	1.5
	2.0	1.06°	595	75.2	2.0	72.7	1.9	66.5	1.5
	2.4	1.06°	595	74.4	2.0	72.7	1.9	66.5	1.5
	3.0	1.06°	595	73.2	1.9	72.7	1.9	66.5	1.5
3.2	1.06°	595	72.8	1.9	72.7	1.9	66.5	1.5	
50	0.2	0.79°	798	98.8	2.1	92.7	1.8	86.5	1.6
	0.4	0.79°	798	98.4	2.1	92.7	1.8	86.5	1.6
	0.8	0.79°	798	97.6	2.1	92.7	1.8	86.5	1.6
	1.0	0.79°	798	97.2	2.0	92.7	1.8	86.5	1.6
	1.2	0.79°	798	96.8	2.0	92.7	1.8	86.5	1.6
	1.6	0.79°	798	96.0	2.0	92.7	1.8	86.5	1.6
	2.0	0.79°	798	95.2	2.0	92.7	1.8	86.5	1.6
	2.4	0.79°	798	94.4	1.9	92.7	1.8	86.5	1.6
	3.0	0.79°	798	93.2	1.9	92.7	1.8	86.5	1.6
3.2	0.79°	798	92.8	1.9	92.7	1.8	86.5	1.6	
63	0.2	0.6°	1051	124.8	2.0	118.7	1.8	112.5	1.6
	0.4	0.6°	1051	124.4	2.0	118.7	1.8	112.5	1.6
	0.8	0.6°	1051	123.6	2.0	118.7	1.8	112.5	1.6
	1.0	0.6°	1051	123.2	2.0	118.7	1.8	112.5	1.6
	1.2	0.6°	1051	122.8	2.0	118.7	1.8	112.5	1.6
	1.6	0.6°	1051	122.0	1.9	118.7	1.8	112.5	1.6
	2.0	0.6°	1051	121.2	1.9	118.7	1.8	112.5	1.6
	2.4	0.6°	1051	120.4	1.9	118.7	1.8	112.5	1.6
	3.0	0.6°	1051	119.2	1.9	118.7	1.8	112.5	1.6
3.2	0.6°	1051	118.8	1.8	118.7	1.8	112.5	1.6	
80	0.2	0.45°	1401	158.8	1.9	152.6	1.8	146.5	1.6
	0.4	0.45°	1401	158.4	1.9	152.7	1.8	146.5	1.6
	0.8	0.45°	1401	157.6	1.9	152.7	1.8	146.5	1.6
	1.0	0.45°	1401	157.2	1.9	152.7	1.8	146.5	1.6
	1.2	0.45°	1401	156.8	1.9	152.7	1.8	146.5	1.6
	1.6	0.45°	1401	156.0	1.9	152.7	1.8	146.5	1.6
	2.0	0.45°	1401	155.2	1.9	152.7	1.8	146.5	1.6
	2.4	0.45°	1401	154.4	1.8	152.7	1.8	146.5	1.6
	3.0	0.45°	1401	153.2	1.8	152.7	1.8	146.5	1.6
3.2	0.45°	1401	152.8	1.8	152.7	1.8	146.5	1.6	

Remarque 1) L'usinage en ramping peut créer des copeaux longs dans les matières ductiles.

* Distance L pour atteindre la profondeur de passe maximale APMX (11 mm) à l'angle de ramping maximal ($L = 11/\tan \alpha$).

Tréflage et perçage

Voir les tableaux de droite pour les engagements et profondeurs de perçage. Pour l'avance par dent et la vitesse de coupe, veuillez utiliser les conditions de coupe pour le rainurage.

● Tréflage

K
FRAISES À PLAQUETTES

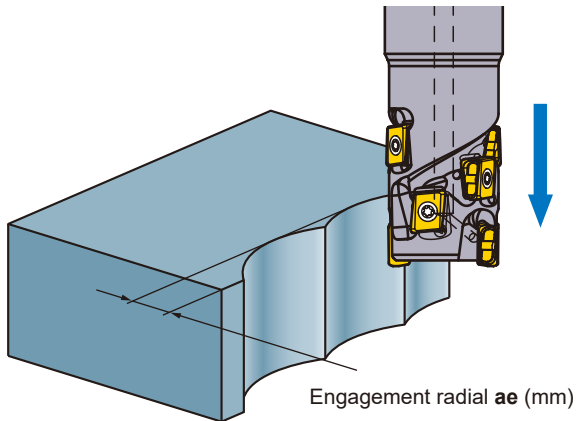

DC (mm)	ae max. (mm)
40	6.7
50	6.7
63	6.7
80	6.7

Remarque 1) Un cycle de déburrage n'est pas nécessaire.

● Perçage

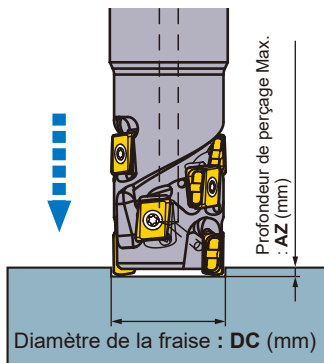

DC (mm)	AZ max. (mm)
40	0.55
50	0.55
63	0.55
80	0.55

Remarque 1) Attention aux projections de copeaux.

Remarque 2) Évacuez les copeaux à l'aide d'air comprimé (ou de liquide d'arrosage lors de l'usinage d'un alliage d'aluminium).

FRAISES MULTI FONCTIONS

90°
KAPR



APX3000

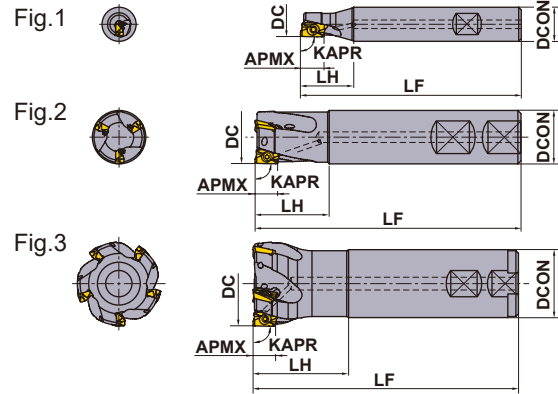

Outil à droite uniquement.

ATTACHEMENT WELDON

KAPR : 90°
Avec trou de lubrification

DC (mm)	Référence	Stock	Nombre de dents	Dimensions (mm)			WT* (kg)	APMX (mm)	RMPX	RPMX (min ⁻¹)	Fig.	Type Plaquette
				DCON	LF	LH						
12	APX3000R121WA16SA	●	1	16	85	25	0.10	10	6.0°	10500	1	AO-T12
14	APX3000R141WA16SA	●	1	16	85	25	0.11	10	6.0°	9000	1	AO-T12
16	APX3000R162WA16SA	●	2	16	85	25	0.11	10	11.3°	20900	2	AO-T12
18	APX3000R182WA16SA	●	2	16	85	25	0.11	10	8.6°	19600	3	AO-T12
18	APX3000R182WA16LA	●	2	16	120	25	0.16	10	8.6°	19600	3	AO-T12
20	APX3000R202WA20SA	●	2	20	100	30	0.21	10	6.9°	18500	2	AO-T12
20	APX3000R203WA20SA	●	3	20	100	30	0.21	10	6.9°	18500	2	AO-T12
20	APX3000R202WA20LA	●	2	20	150	60	0.32	10	6.9°	18500	2	AO-T12
22	APX3000R223WA20SA	●	3	20	115	30	0.25	10	5.7°	17600	3	AO-T12
22	APX3000R222WA20LA	●	2	20	150	30	0.34	10	5.7°	17600	3	AO-T12
25	APX3000R252WA25SA	●	2	25	115	35	0.38	10	4.6°	16400	2	AO-T12
25	APX3000R253WA25SA	●	3	25	115	35	0.38	10	4.6°	16400	2	AO-T12
25	APX3000R254WA25SA	●	4	25	115	35	0.38	10	4.6°	16400	2	AO-T12
25	APX3000R253WA25LA	●	3	25	170	70	0.51	10	4.6°	16400	2	AO-T12
28	APX3000R284WA25SA	●	4	25	115	35	0.40	10	3.8°	15500	3	AO-T12
28	APX3000R283WA25LA	●	3	25	170	35	0.61	10	3.8°	15500	3	AO-T12
30	APX3000R304WA32SA	●	4	32	125	45	0.64	10	3.4°	14900	1	AO-T12
32	APX3000R323WA32SA	●	3	32	125	45	0.68	10	3.1°	14400	2	AO-T12
32	APX3000R324WA32SA	●	4	32	125	45	0.67	10	3.1°	14400	2	AO-T12
32	APX3000R325WA32SA	●	5	32	125	45	0.68	10	3.1°	14400	2	AO-T12
35	APX3000R353WA32LA	●	3	32	190	45	1.11	10	2.7°	13700	3	AO-T12
40	APX3000R403WA32SA	□	3	32	125	45	0.75	10	2.2°	12800	3	AO-T12
40	APX3000R405WA32SA	●	5	32	125	45	0.75	10	2.2°	12800	3	AO-T12
40	APX3000R406WA32SA	●	6	32	125	45	0.76	10	2.2°	12800	3	AO-T12

Remarque 1) Lors de l'utilisation de plaquettes avec rayons $RE \geq 2.4\text{mm}$, veuillez usiner le porte-outil comme indiqué à la page K137.

Remarque 2) Les vitesses de rotation maximum (RPMX) préconisées assurent fiabilité de l'outil et de la plaquette.

Remarque 3) Lorsque vous utilisez un outil en usinage à grande vitesse, assurez-vous que l'outil et l'attache sont correctement équilibrés.

* WT : Poids de l'outil

K

FRAISES À PLAQUETTES

● : Article stocké. □ : Article non stocké - Fabrication sur commande uniquement.

PIÈCES DÉTACHÉES > N001
DONNÉES TECHNIQUES > P001

K133

FRAISES À PLAQUETTES

K

FRAISES À PLAQUETTES

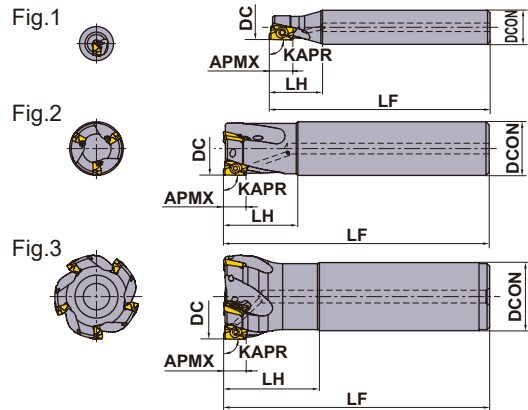

Outil à droite uniquement.

■ FRAISE À QUEUE CYLINDRIQUE

KAPR : 90°
Avec trou de lubrification

DC (mm)	Référence	Stock R	Nombre de dents	Dimensions (mm)			WT* (kg)	APMX (mm)	RMPX	RPMX (min ⁻¹)	Fig.	Type Plaquette
				DCON	LF	LH						
12	APX3000R121SA16SA	★	1	16	85	25	0.10	10	6.0°	10500	1	AO○T12
14	APX3000R141SA16SA	★	1	16	85	25	0.11	10	6.0°	9000	1	AO○T12
16	APX3000R162SA16SA	●	2	16	85	25	0.11	10	11.3°	20900	2	AO○T12
18	APX3000R182SA16SA	★	2	16	85	25	0.11	10	8.6°	19600	3	AO○T12
18	APX3000R182SA16LA	●	2	16	120	25	0.16	10	8.6°	19600	3	AO○T12
18	APX3000R182SA16ELA	●	2	16	180	25	0.25	10	8.6°	19600	3	AO○T12
20	APX3000R202SA20SA	★	2	20	100	30	0.21	10	6.9°	18500	2	AO○T12
20	APX3000R203SA20SA	●	3	20	100	30	0.21	10	6.9°	18500	2	AO○T12
20	APX3000R202SA20LA	●	2	20	150	60	0.32	10	6.9°	18500	2	AO○T12
20	APX3000R202SA20ELA	★	2	20	200	70	0.42	10	6.9°	18500	2	AO○T12
22	APX3000R223SA20SA	●	3	20	115	30	0.25	10	5.7°	17600	3	AO○T12
22	APX3000R222SA20LA	●	2	20	150	30	0.34	10	5.7°	17600	3	AO○T12
22	APX3000R222SA20ELA	★	2	20	200	30	0.45	10	5.7°	17600	3	AO○T12
25	APX3000R252SA25SA	★	2	25	115	35	0.38	10	4.6°	16400	2	AO○T12
25	APX3000R253SA25SA	★	3	25	115	35	0.38	10	4.6°	16400	2	AO○T12
25	APX3000R254SA25SA	●	4	25	115	35	0.38	10	4.6°	16400	2	AO○T12
25	APX3000R252SA25LA	★	2	25	170	70	0.51	10	4.6°	16400	2	AO○T12
25	APX3000R253SA25LA	★	3	25	170	70	0.51	10	4.6°	16400	2	AO○T12
25	APX3000R252SA25ELA	★	2	25	220	80	0.75	10	4.6°	16400	2	AO○T12
25	APX3000R253SA25ELA	★	3	25	220	80	0.75	10	4.6°	16400	2	AO○T12
28	APX3000R284SA25SA	★	4	25	115	35	0.40	10	3.8°	15500	3	AO○T12
28	APX3000R282SA25LA	★	2	25	170	35	0.61	10	3.8°	15500	3	AO○T12
28	APX3000R283SA25LA	★	3	25	170	35	0.61	10	3.8°	15500	3	AO○T12
28	APX3000R282SA25ELA	★	2	25	220	35	0.80	10	3.8°	15500	3	AO○T12
28	APX3000R283SA25ELA	★	3	25	220	35	0.79	10	3.8°	15500	3	AO○T12
30	APX3000R304SA32SA	★	4	32	125	45	0.64	10	3.4°	14900	2	AO○T12
32	APX3000R323SA32SA	★	3	32	125	45	0.68	10	3.1°	14400	2	AO○T12
32	APX3000R324SA32SA	★	4	32	125	45	0.67	10	3.1°	14400	2	AO○T12
32	APX3000R325SA32SA	★	5	32	125	45	0.68	10	3.1°	14400	2	AO○T12
32	APX3000R322SA32LA	★	2	32	190	90	1.07	10	3.1°	14400	2	AO○T12
32	APX3000R323SA32LA	★	3	32	190	90	1.05	10	3.1°	14400	2	AO○T12
32	APX3000R322SA32ELA	★	2	32	260	100	1.47	10	3.1°	14400	2	AO○T12
32	APX3000R323SA32ELA	★	3	32	260	100	1.45	10	3.1°	14400	2	AO○T12
35	APX3000R352SA32LA	★	2	32	190	45	1.12	10	2.7°	13700	3	AO○T12
35	APX3000R353SA32LA	★	3	32	190	45	1.11	10	2.7°	13700	3	AO○T12
35	APX3000R352SA32ELA	★	2	32	260	45	1.53	10	2.7°	13700	3	AO○T12
35	APX3000R353SA32ELA	★	3	32	260	45	1.52	10	2.7°	13700	3	AO○T12
40	APX3000R403SA32SA	★	3	32	125	45	0.75	10	2.2°	12800	3	AO○T12
40	APX3000R405SA32SA	★	5	32	125	45	0.75	10	2.2°	12800	3	AO○T12
40	APX3000R406SA32SA	★	6	32	125	45	0.76	10	2.2°	12800	3	AO○T12
50	APX3000R507SA32SA	★	7	32	125	45	0.90	10	1.7°	11300	3	AO○T12
63	APX3000R638SA32SA	★	8	32	125	45	1.04	10	1.3°	10000	3	AO○T12

Remarque 1) Lors de l'utilisation de plaquettes avec rayons RE ≥ 2.4mm, veuillez usiner le porte-outil comme indiqué à la page K137.

Remarque 2) Les vitesses de rotation maximum (RPMX) préconisées assurent fiabilité de l'outil et de la plaquette.

Remarque 3) Lorsque vous utilisez un outil en usinage à grande vitesse, assurez-vous que l'outil et l'attachement sont correctement équilibrés.

* WT : Poids de l'outil

● : Article stocké. ★ : Article standard Japon.

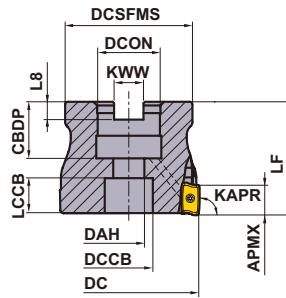

■ ATTACHEMENT PAR ALÉSAGE

Outil à droite uniquement.

KAPR :90°

GAMP:+7°-+21° GAMF:+15°-+27°

Avec trou de lubrification

DC (mm)	Vis d'attachement	Géométrie
32, 40	HSC08030H	
50, 63	HSC10030H	
80	HSC12035H	
100	HSC16040H	

DC (mm)	Référence	Stock	Nombre de dents	Dimensions (mm)		WT* (kg)	APMX (mm)	RMPX	RPMX (min ⁻¹)	 Type Plaque
				LF	DCON					
32	APX3000-032A05RA	●	5	40	16	0.2	10	3.1°	14400	AO-T12
40	APX3000-040A06RA	●	6	40	16	0.3	10	2.2°	12800	AO-T12
50	APX3000-050A07RA	●	7	40	22	0.4	10	1.7°	11300	AO-T12
63	APX3000-063A08RA	●	8	40	22	0.7	10	1.3°	10000	AO-T12
80	APX3000-080A09RA	●	9	50	27	1.3	10	1.0°	8800	AO-T12
100	APX3000-100A11RA	●	11	63	32	2.2	10	0.8°	7800	AO-T12

Remarque 1) Lors de l'utilisation de plaquettes avec rayons RE ≥ 2.4mm, veuillez usiner le porte-outil comme indiqué à la page K137.

Remarque 2) Les vitesses de rotation maximum (RPMX) préconisées assurent fiabilité de l'outil et de la plaquette.

Remarque 3) Lorsque vous utilisez un outil en usinage à grande vitesse, assurez-vous que l'outil et l'attachement sont correctement équilibrés.

* WT : Poids de l'outil

DIMENSIONS DE MONTAGE

DC (mm)	Référence	Dimensions (mm)							
		DCON	CBDP	DAH	DCCB	LCCB	DCSFMS	KWW	L8
32	APX3000-032A05RA	16	18	9	14	10.22	30	8.4	5.6
40	APX3000-040A06RA	16	18	9	14	10.35	34	8.4	5.6
50	APX3000-050A07RA	22	20	11	17	12.35	45	10.4	6.3
63	APX3000-063A08RA	22	20	11	17	12.35	55	10.4	6.3
80	APX3000-080A09RA	27	23	13	20	16.35	70	12.4	7
100	APX3000-100A11RA	32	26	17	26	26.35	80	14.4	8

FRAISES À PLAQUETTES

K

FRAISES À PLAQUETTES

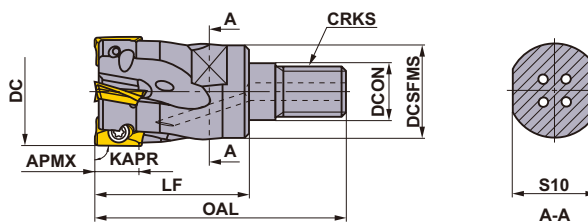
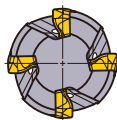

■ FRAISE À EMBOUT FILETÉ

KAPR : 90°
Avec trou de lubrification

Outil à droite uniquement.

DC (mm)	Référence	Stock		Nombre de dents	Dimensions (mm)						WT [*] (kg)	APMX (mm)	RMPX	Type Plaque
		R			DCON	DCSFMS	OAL	LF	S10	CRKS				
16	APX3000R162M08A	●	2	2	8.5	13	48	30	10	M8	0.1	10	11.3°	AO-T12
18	APX3000R182M08A30	★	2	2	8.5	13	48	30	10	M8	0.1	10	8.6°	AO-T12
20	APX3000R203M10A	●	3	3	10.5	18	49	30	14	M10	0.1	10	6.9°	AO-T12
22	APX3000R223M10A30	★	3	3	10.5	18	49	30	14	M10	0.1	10	5.7°	AO-T12
25	APX3000R254M12A	●	4	4	12.5	21	57	35	19	M12	0.2	10	4.6°	AO-T12
28	APX3000R284M12A35	★	4	4	12.5	21	57	35	19	M12	0.2	10	3.8°	AO-T12
30	APX3000R304M16A40	★	4	4	17	29	63	40	24	M16	0.3	10	3.4°	AO-T12
32	APX3000R325M16A	●	5	5	17	29	63	40	24	M16	0.3	10	3.1°	AO-T12
35	APX3000R355M16A40	★	5	5	17	29	63	40	24	M16	0.3	10	2.7°	AO-T12
40	APX3000R406M16A	●	6	6	17	29	63	40	24	M16	0.3	10	2.2°	AO-T12

Remarque 1) Lors de l'utilisation de plaquettes avec rayons RE ≥ 2.4mm, veuillez usiner le porte-outil comme indiqué à la page K137.

Remarque 2) Pour les attachements à visser, voir page K244.

* WT : Poids de l'outil

PIÈCES DÉTACHÉES





DC (mm)	Porte-outil Type	DC (mm)	Porte-outil Type	Vis de fixation	Clé	Anti-grippant
				*		
12	APX3000R12	14	APX3000R14	TPS25	TIP07F	MK1KS
16	APX3000R16	18	APX3000R18	TPS25	TIP07F	MK1KS
20	APX3000R20			TPS25	TIP07F	MK1KS
22	APX3000R22	25	APX3000R25	TPS25-1	TIP07F	MK1KS
28	APX3000R28	30	APX3000R30	TPS25-1	TIP07F	MK1KS
32	APX3000R32	32	APX3000-032	TPS25-1	TIP07F	MK1KS
35	APX3000R35			TPS25-1	TIP07F	MK1KS
40	APX3000R40	40	APX3000-040	TPS25-1	TIP07F	MK1KS
50	APX3000R50	50	APX3000-050	TPS25-1	TIP07F	MK1KS
63	APX3000R63	63	APX3000-063	TPS25-1	TIP07F	MK1KS
80	APX3000-080			TPS25-1	TIP07F	MK1KS
100	APX3000-100			TPS25-1	TIP07F	MK1KS

* Couple de serrage (N · m) : TPS25 = 1,0, TPS25-1 = 1,0

● : Article stocké. ★ : Article standard Japon.

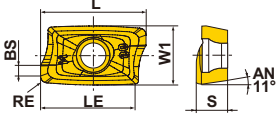
(10 plaquettes par boîte)

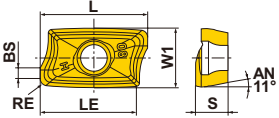
PLAQUETTES

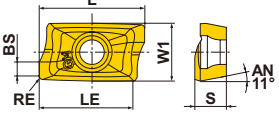
Matière	P	Acier																Conditions de coupe (Guide):						
	M	Acier Inoxydable																● : Coupe Stable ● : Coupe Générale ✦ : Coupe Instable						
Matière	K	Fonte																Honing :						
	N	Non ferreux																E : Ronde F : Affûtée						
	S	Alliage réfractaire, Alliage titane																						
Matière	H	Acier trempé																						
Forme	Référence	Classe	Honing	Revêtu													Carbure	Dimensions (mm)						Géométrie
				MC5020	MP6120	MP6130	MP7130	MP9120	MP9130	VP15TF	VP20RT	TF15	L	LE	W1	S		BS	RE	*				
Générale Brise-copeaux M 	AOMT123602PEER-M	M	E	●	●	●	●	●	●	●	●	●	●	●				12	10	6.6	3.6	1.8	0.2	
	AOMT123604PEER-M	M	E	●	●	●	●	●	●	●	●	●	●	●				12	10	6.6	3.6	1.6	0.4	
	AOMT123608PEER-M	M	E	●	●	●	●	●	●	●	●	●	●	●				12	10	6.6	3.6	1.2	0.8	
	AOMT123610PEER-M	M	E	●	●	●	●	●	●	●	●	●	●	●				12	10	6.6	3.6	1.0	1.0	
	AOMT123612PEER-M	M	E	●	●	●	●	●	●	●	●	●	●	●				12	10	6.6	3.6	0.8	1.2	
	AOMT123616PEER-M	M	E	●	●	●	●	●	●	●	●	●	●	●				12	10	6.6	3.6	0.4	1.6	
	AOMT123620PEER-M	M	E	●	●	●	●	●	●	●	●	●	●	●				12	10	6.6	3.6	0.4	2.0	
	AOMT123624PEER-M	M	E	●	●	●	●	●	●	●	●	●	●	●				12	10	6.6	3.6	0.4	2.4	
	AOMT123630PEER-M	M	E	●	●	●	●	●	●	●	●	●	●	●				12	10	6.6	3.6	0.4	3.0	
	AOMT123632PEER-M	M	E	●	●	●	●	●	●	●	●	●	●	●				12	10	6.6	3.6	0.4	3.2	
Arête de coupe renforcée Brise-copeaux H 	AOMT123604PEER-H	M	E	●	●	●	●	●	●	●	●	●	●				12	10	6.6	3.6	1.6	0.4		
	AOMT123608PEER-H	M	E	●	●	●	●	●	●	●	●	●	●				12	10	6.6	3.6	1.2	0.8		
	AOMT123616PEER-H	M	E	●	●	●	●	●	●	●	●	●	●				12	10	6.6	3.6	0.4	1.6		
Pour l'usinage des alliages d'aluminium Brise-copeaux GM 	AOGT123602PEFR-GM	G	F											●			12	10	6.6	3.6	1.8	0.2		
	AOGT123604PEFR-GM	G	F											●			12	10	6.6	3.6	1.6	0.4		
	AOGT123608PEFR-GM	G	F											●			12	10	6.6	3.6	1.2	0.8		

* Selon l'angle de coupe radial du corps, le rayon R réalisé sur la pièce peut être différent du rayon de plaquette RE.

Note pour l'utilisation des plaquettes à grand rayon

En utilisant une plaquette avec un rayon $RE \geq R2.4\text{mm}$, l'usinage du porte-outil en forme de rayon est recommandé, voir ci-contre.

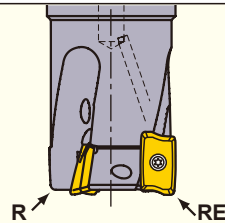

RE (mm)	R (mm)
2.4	1.9
3.0	2.5
3.2	2.7

R : Rayon en bout du porte-outil
RE : Rayon plaquette

K

FRAISES À PLAQUETTES

FRAISES À PLAQUETTES

CONDITIONS DE COUPE RECOMMANDÉES

VITESSE DE COUPE

Matière	Dureté	Plaquette			ae (mm)			
		Priorité de nuance		Brise-copeaux	≤0.25DC	0.25–0.5DC	0.5–0.75DC	DC (rainure)
		1ère	2nde					
P	≤180HB	MP6120	VP15TF	M H	230(180–270)	220(170–260)	180(140–210)	180(140–210)
		MP6130	VP20RT	M H	200(150–240)	190(140–230)	150(110–180)	150(110–180)
	180–350HB	MP6120	VP15TF	M H	180(140–210)	170(130–200)	140(110–160)	140(110–160)
		MP6130	VP20RT	M H	150(110–180)	140(100–170)	110(80–130)	110(80–130)
M	≤270HB	MP7130	VP20RT	M H	180(140–210)	170(130–200)	140(110–160)	140(110–160)
K	≤350MPa	MC5020	VP15TF	H –	250(200–300)	240(190–290)	210(160–260)	140(110–160)
	≤800MPa	MC5020	VP15TF	H –	130(100–150)	120(90–140)	100(80–120)	100(80–120)
N	–	TF15	–	GM –	500(200–1000)	500(200–1000)	500(200–1000)	500(200–1000)
S	≤350HB	MP9120	VP15TF	M H	50(40–70)	–	–	50(40–70)
		MP9130	VP20RT	M H	40(30–60)	–	–	40(30–60)
	–	MP9120	VP15TF	M H	40(30–60)	–	–	40(30–60)
		MP9130	VP20RT	M H	30(20–40)	–	–	30(20–40)
H	40–55HRC	VP15TF	–	H –	90(70–100)	85(60–100)	70(50–80)	70(50–80)

PROFONDEUR DE PASSE ET AVANCE PAR DENT

Matière	Dureté	ae (mm)	DC (mm)					
			ø12–ø16		ø18–ø25		ø28–ø100	
			Profondeur de passe ap (mm)	Avance par dent fz (mm/dent)	Profondeur de passe ap (mm)	Avance par dent fz (mm/dent)	Profondeur de passe ap (mm)	Avance par dent fz (mm/dent)
P	≤180HB 180–350HB	≤0.25DC	≤4	0.15	≤5	0.25	≤5	0.20
			4–7	0.10	5–7	0.20	5–7	0.15
			–	–	7–8.5	0.15	7–8.5	0.10
			–	–	8.5–10	0.10	8.5–10	0.07
		0.25–0.5DC	≤2	0.15	≤3	0.25	≤3	0.20
			2–5	0.10	3–5.5	0.20	3–5.5	0.15
			–	–	5.5–8	0.15	5.5–8	0.10
			–	–	8–10	0.10	8–10	0.07
		0.5–0.75DC	≤4	0.10	≤4	0.15	≤3	0.10
			–	–	4–10	0.10	3–7	0.07
		DC (rainure)	≤3	0.10	≤4	0.10	≤3	0.10
			–	–	4–7	0.07	3–5	0.07
M	≤270HB	≤0.25DC	≤4	0.15	≤5	0.20	≤5	0.20
			4–7	0.10	5–7	0.15	5–7	0.15
			–	–	7–8.5	0.10	7–8.5	0.10
			–	–	8.5–10	0.07	8.5–10	0.07
		0.25–0.5DC	≤2	0.15	≤3	0.20	≤3	0.20
			2–5	0.10	3–5.5	0.15	3–5.5	0.15
			–	–	5.5–8	0.10	5.5–8	0.10
			–	–	8–10	0.07	8–10	0.07
		0.5–0.75DC	≤4	0.10	≤4	0.10	≤3	0.10
			–	–	4–10	0.07	3–7	0.07
		DC (rainure)	≤3	0.10	≤4	0.10	≤3	0.10
			–	–	4–7	0.07	3–5	0.07
K	Résistance à la traction ≤350MPa	≤0.25DC	≤4	0.15	≤5	0.25	≤5	0.20
			4–7	0.10	5–7	0.20	5–7	0.15
			–	–	7–8.5	0.15	7–8.5	0.10
			–	–	8.5–10	0.10	8.5–10	0.07
		0.25–0.5DC	≤2	0.15	≤3	0.25	≤3	0.20
			2–5	0.10	3–5.5	0.20	3–5.5	0.15
			–	–	5.5–8	0.15	5.5–8	0.10
			–	–	8–10	0.10	8–10	0.07
		0.5–0.75DC	≤4	0.10	≤4	0.15	≤3	0.10
			–	–	4–10	0.10	3–7	0.07
		DC (rainure)	≤3	0.10	≤4	0.10	≤3	0.10
			–	–	4–7	0.07	3–5	0.07
	Résistance à la traction ≤800MPa	≤0.25DC	≤4	0.10	≤5	0.20	≤5	0.20
			4–7	0.07	5–7	0.15	5–7	0.15
			–	–	7–8.5	0.10	7–8.5	0.10
			–	–	8.5–10	0.07	8.5–10	0.07
		0.25–0.5DC	≤2	0.10	≤3	0.20	≤3	0.20
			2–5	0.07	3–5.5	0.15	3–5.5	0.15
			–	–	5.5–8	0.10	5.5–8	0.10
			–	–	8–10	0.07	8–10	0.07
		0.5–0.75DC	≤4	0.07	≤4	0.10	≤3	0.10
			–	–	4–10	0.07	3–7	0.07
		DC (rainure)	≤3	0.07	≤4	0.10	≤3	0.10
			–	–	4–7	0.07	3–5	0.07

Matière	Dureté	ae (mm)	DC (mm)					
			ø12-ø16		ø18-ø25		ø28-ø100	
			Profondeur de passe ap (mm)	Avance par dent fz (mm/dent)	Profondeur de passe ap (mm)	Avance par dent fz (mm/dent)	Profondeur de passe ap (mm)	Avance par dent fz (mm/dent)
N Alliage aluminium	-	≤ 0.25DC	≤ 4	0.15	≤ 4	0.25	≤ 4	0.20
			4-7	0.10	4-7	0.15	4-7	0.10
		0.25-0.5DC	≤ 4	0.15	≤ 4	0.20	≤ 4	0.20
			4-7	0.10	4-7	0.10	4-7	0.10
S Alliage titane	≤ 350HB	≤ 0.25DC	≤ 4	0.15	≤ 4	0.15	≤ 4	0.10
			4-7	0.10	4-7	0.10	4-7	0.07
		0.25-0.5DC	≤ 3	0.05	≤ 3	0.05	≤ 3	0.05
			4-7	0.10	4-7	0.10	4-7	0.10
H Acier trempé	40-55HRC	≤ 0.25DC	≤ 4	0.10	≤ 5	0.15	≤ 5	0.15
			4-7	0.07	5-7	0.10	5-7	0.10
		0.25-0.5DC	-	-	7-8.5	0.07	-	-
			≤ 2	0.10	≤ 3	0.15	≤ 3	0.15
H Alliage réfractaire	-	0.5-0.75DC	2-5	0.07	3-5.5	0.10	-	-
			≤ 4	0.07	≤ 4	0.07	≤ 3	0.07
		DC (rainure)	≤ 3	0.07	≤ 4	0.07	≤ 3	0.07
			≤ 1	0.05	≤ 1	0.05	≤ 1	0.05

Remarque 1) Ces conditions de coupe sont un guide pour les attachements standards et par alésage.

Ajuster en fonction des conditions d'usinage.

Remarque 2) Les vibrations peuvent survenir dans certains cas. Réduire la profondeur de passe et / ou réduire les conditions de coupe dans les cas suivants:

- Quand on utilise un attachement long.
- Quand il y a un long porte-à-faux avec un attachement standard ou à alésage.
- Quand il y a des applications avec un mauvais serrage ou quand on utilise une machine de faible rigidité.

Remarque 3) Dans le cas de fraise à pas large ou à pas fin, le pas large est recommandé pour prévenir des vibrations.

Remarque 4) Le brise-copeaux H est la première recommandation pour une coupe fortement interrompue et instable.

RAMPING / INTERPOLATION HÉLICOÏDALE

RAMPING

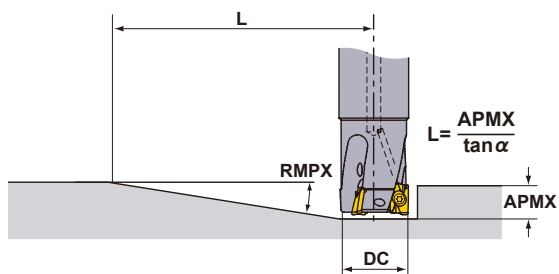

INTERPOLATION HÉLICOÏDALE

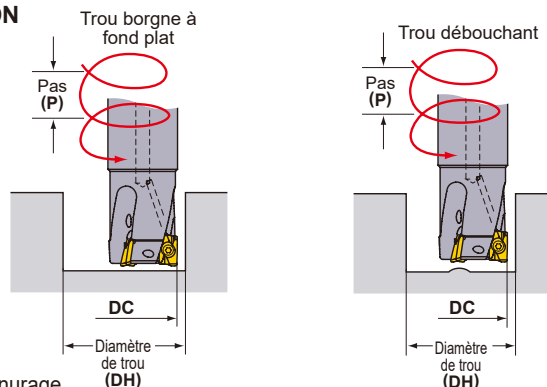

Se référer au tableau ci-dessous pour les conditions de coupe.

Pour l'avance par dent et la vitesse de coupe, se référer aux conditions de coupe pour rainurage.

Diamètre de l'arête de coupe DC(mm)	Ramping		Interpolation Hélicoïdale (Trou borgne à fond plat)				Interpolation Hélicoïdale (Trou débouchant)		
	Angle max. de ramping RMPX	Distance *1 minimum L(mm)	Diamètre de *2 trou maximum DH max.(mm)	Pas maximum P max.(mm)	Diamètre de trou minimum DH min.(mm)	Pas maximum P max.(mm)	Diamètre de trou minimum DH min.(mm)	Pas maximum P max.(mm)	
12	6.0°	95	22	2.5	20.5	2	14	0.5	
14	6.0°	95	26	2.5	24.5	2	18	1	
16	11.3°	50	30	9	28	7	21	2	
18	8.6°	66	34	5	32	4.5	25	2	
20	6.9°	83	38	5	36	4.5	29	2	
22	5.7°	100	42	5	40	4.5	33	2	
25	4.6°	124	48	6	46	5	39	3	
28	3.8°	151	54	4.5	52	4	45	2	
30	3.4°	168	58	4.5	56	4	49	2	
32	3.1°	185	62	4.5	60	4	53	2	
35	2.7°	212	68	4	66	3.5	59	2	
40	2.2°	260	78	4	76	3.5	69	2	
50	1.7°	337	98	2	96	2	89	2	
63	1.3°	441	124	2	122	2	115	2	
80	1.0°	573	158	2	156	2	149	2	
100	0.8°	716	198	1	196	1	189	1	

Remarque 1) Lors d'usinage de matières ductiles aux angles de ramping ci-dessus, peut donner lieu à la formation de copeaux continue.

Dans ce cas, nous recommandons de réduire l'angle de ramping ou l'avance à la dent.

*1 L (=10/tan α). Distance de déplacement des fraises jusqu'à atteindre une profondeur de coupe de 10 mm à l'angle de ramping maximum.

*2 Pour un rayon de pointe de 0,8 mm. Si l'angle est différent, utilisez la formule suivante.

$$\{(\text{diamètre d'arête de coupe DC}) - (\text{rayon de pointe}) - 0,2\} \times 2$$

FRAISES À PLAQUETTES

FRAISES MULTI FONCTIONS

90°
KAPR



APX4000



K

FRAISES À PLAQUETTES



Fig.1

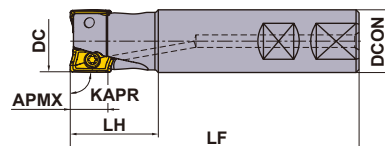
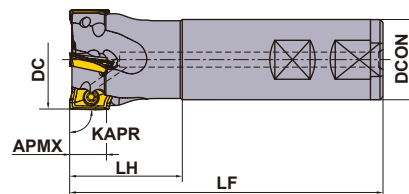
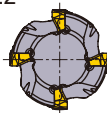

Fig.2



Outil à droite uniquement.

ATTACHEMENT WELDON

KAPR : 90°
Avec trou de lubrification

DC (mm)	Référence	Stock	Nombre de dents	Dimensions (mm)			WT* (kg)	APMX (mm)	RMPX	RPMX (min ⁻¹)	Fig.	Type Plaquette
				DCON	LF	LH						
25	APX4000R252WA25SA	●	2	25	115	35	0.40	15	11°	18900	1	AO-T18
25	APX4000R252WA25LA	●	2	25	170	35	0.61	15	11°	18900	1	AO-T18
25	APX4000R252WA25ELA	●	2	25	220	80	0.76	15	11°	18900	1	AO-T18
28	APX4000R282WA25LA	●	2	25	170	35	0.63	15	9°	17700	2	AO-T18
28	APX4000R282WA25ELA	●	2	25	220	35	0.81	15	9°	17700	2	AO-T18
32	APX4000R323WA32SA	●	3	32	125	45	0.71	15	7°	16300	1	AO-T18
32	APX4000R323WA32LA	●	3	32	190	45	1.11	15	7°	16300	1	AO-T18
32	APX4000R323WA32ELA	●	3	32	260	100	1.49	15	7°	16300	1	AO-T18
35	APX4000R353WA32LA	●	3	32	190	45	1.14	15	6°	15400	2	AO-T18
40	APX4000R403WA32SA	●	3	32	125	45	0.80	15	6°	14200	2	AO-T18
40	APX4000R404WA32SA	●	4	32	125	45	0.80	15	6°	14200	2	AO-T18
40	APX4000R404WA32LA	●	4	32	190	45	1.19	15	6°	14200	2	AO-T18

Remarque 1) Lors de l'utilisation de plaquettes avec rayons $RE \geq 3.2\text{mm}$, veuillez usiner le porte-outil comme indiqué à la page K144.

Remarque 2) Les vitesses de rotation maximum (RPMX) préconisées assurent fiabilité de l'outil et de la plaquette.

Remarque 3) Lorsque vous utilisez un outil en usinage à grande vitesse, assurez-vous que l'outil et l'attache sont correctement équilibrés.

* WT : Poids de l'outil

● : Article stocké. ★ : Article standard Japon.



Fig.1

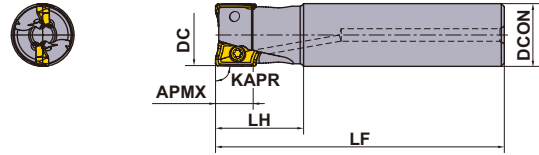
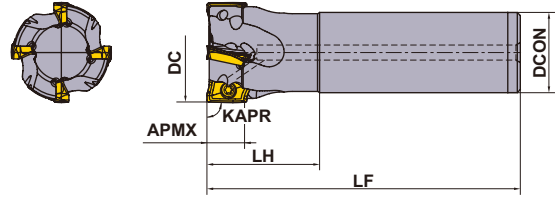

Fig.2



Outil à droite uniquement.

■ FRAISE À QUEUE CYLINDRIQUE

KAPR : 90°
Avec trou de lubrification

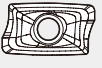
DC (mm)	Référence	Stock	Nombre de dents	Dimensions (mm)			WT* (kg)	APMX (mm)	RMPX	RPMX (min ⁻¹)	Fig.	 Type Plaquette
				DCON	LF	LH						
25	APX4000R252SA25SA	★	2	25	115	35	0.40	15	11.0°	18900	1	AO○T18
25	APX4000R252SA25LA	★	2	25	170	35	0.61	15	11.0°	18900	1	AO○T18
25	APX4000R252SA25ELA	★	2	25	220	80	0.76	15	11.0°	18900	1	AO○T18
28	APX4000R282SA25LA	★	2	25	170	35	0.63	15	9.0°	17700	2	AO○T18
28	APX4000R282SA25ELA	★	2	25	220	35	0.81	15	9.0°	17700	2	AO○T18
32	APX4000R322SA32SA	★	2	32	125	45	0.71	15	7.0°	16300	1	AO○T18
32	APX4000R323SA32SA	★	3	32	125	45	0.71	15	7.0°	16300	1	AO○T18
32	APX4000R322SA32LA	★	2	32	190	45	1.11	15	7.0°	16300	1	AO○T18
32	APX4000R323SA32LA	★	3	32	190	45	1.11	15	7.0°	16300	1	AO○T18
32	APX4000R322SA32ELA	★	2	32	260	100	1.49	15	7.0°	16300	1	AO○T18
32	APX4000R323SA32ELA	★	3	32	260	100	1.49	15	7.0°	16300	1	AO○T18
35	APX4000R352SA32LA	★	2	32	190	45	1.14	15	6.0°	15400	2	AO○T18
35	APX4000R353SA32LA	★	3	32	190	45	1.14	15	6.0°	15400	2	AO○T18
35	APX4000R352SA32ELA	★	2	32	260	45	1.57	15	6.0°	15400	2	AO○T18
35	APX4000R353SA32ELA	★	3	32	260	45	1.57	15	6.0°	15400	2	AO○T18
40	APX4000R403SA32SA	★	3	32	125	45	0.80	15	6.0°	14200	2	AO○T18
40	APX4000R404SA32SA	★	4	32	125	45	0.80	15	6.0°	14200	2	AO○T18
40	APX4000R402SA32LA	★	2	32	190	45	1.19	15	6.0°	14200	2	AO○T18
40	APX4000R403SA32LA	★	3	32	190	45	1.19	15	6.0°	14200	2	AO○T18
40	APX4000R404SA32LA	★	4	32	190	45	1.19	15	6.0°	14200	2	AO○T18
40	APX4000R402SA32ELA	★	2	32	260	45	1.62	15	6.0°	14200	2	AO○T18
40	APX4000R403SA32ELA	★	3	32	260	45	1.62	15	6.0°	14200	2	AO○T18
40	APX4000R404SA32ELA	★	4	32	260	45	1.62	15	6.0°	14200	2	AO○T18
50	APX4000R504SA32SA	★	4	32	125	45	0.93	15	4.0°	12400	2	AO○T18
50	APX4000R505SA32SA	★	5	32	125	45	0.93	15	4.0°	12400	2	AO○T18
63	APX4000R634SA32SA	★	4	32	125	45	1.15	15	3.0°	10800	2	AO○T18
63	APX4000R636SA32SA	★	6	32	125	45	1.15	15	3.0°	10800	2	AO○T18

Remarque 1) Lors de l'utilisation de plaquettes avec rayons $RE \geq 3.2\text{mm}$, veuillez usiner le porte-outil comme indiqué à la page K144.

Remarque 2) Les vitesses de rotation maximum (RPMX) préconisées assurent fiabilité de l'outil et de la plaquette.

Remarque 3) Lorsque vous utilisez un outil en usinage à grande vitesse, assurez-vous que l'outil et l'attache sont correctement équilibrés.

* WT : Poids de l'outil

FRAISES À PLAQUETTES



K

FRAISES À PLAQUETTES

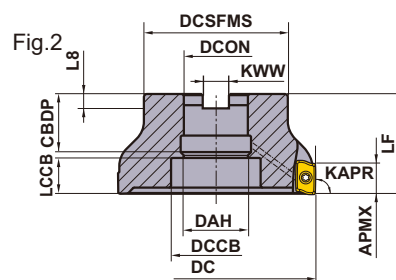
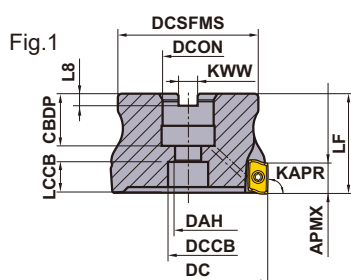

Outil à droite uniquement.

ATTACHEMENT PAR ALÉSAGE

KAPR :90°
GAMP: +15°—+22° GAMF: +21°—+28°
Avec trou de lubrification

DC (mm)	Vis d'attachement	Géométrie
40	HSC08030H	①
50, 63	HSC10030H	
80	HSC12035H	②
100	HSC16040H	
125	MBA20040H	
160	MBA24045H	

DC (mm)	Référence	Stock	Nombre de dents	Dimensions (mm)		WT* (kg)	APMX (mm)	RMPX	RPMX (min ⁻¹)	Fig.		Type Plaque
				LF	DCON							
40	APX4000-040A04RA	●	4	40	16	0.2	15	6.0°	14200	1		AO-T18
50	APX4000-050A05RA	●	5	40	22	0.3	15	4.0°	12400	1		AO-T18
63	APX4000-063A06RA	●	6	40	22	0.5	15	3.0°	10800	1		AO-T18
80	APX4000-080A07RA	●	7	50	27	1.2	15	2.0°	9300	1		AO-T18
100	APX4000-100A08RA	●	8	50	32	2.1	15	1.5°	8100	1		AO-T18
125	APX4000-125A09RA	●	9	63	40	3.3	15	1.0°	7100	2		AO-T18
160	APX4000-160A10RA	●	10	63	40	4.8	15	1.0°	6100	2		AO-T18

Remarque 1) Lors de l'utilisation de plaquettes avec rayons RE ≥ 3.2mm, veuillez usiner le porte-outil comme indiqué à la page K144.

Remarque 2) Les vitesses de rotation maximum (RPMX) préconisées assurent fiabilité de l'outil et de la plaquette.

Remarque 3) Lorsque vous utilisez un outil en usinage à grande vitesse, assurez-vous que l'outil et l'attachement sont correctement équilibrés.

* WT : Poids de l'outil

DIMENSIONS DE MONTAGE

DC (mm)	Référence	Dimensions (mm)							
		DCON	CBDP	DAH	DCCB	LCCB	DCSFMS	KWW	L8
40	APX4000-040A04RA	16	18	9	14	10.08	34	8.4	5.6
50	APX4000-050A05RA	22	20	11	17	12.26	45	10.4	6.3
63	APX4000-063A06RA	22	20	11	17	12.35	50	10.4	6.3
80	APX4000-080A07RA	27	23	13	20	15.35	60	12.4	7
100	APX4000-100A08RA	32	26	17	27	17.35	70	14.4	8
125	APX4000-125A09RA	40	40	42	56	22.35	90	16.4	9
160	APX4000-160A10RA	40	40	42	72	22.35	100	16.4	9

● : Article stocké. ★ : Article standard Japon.

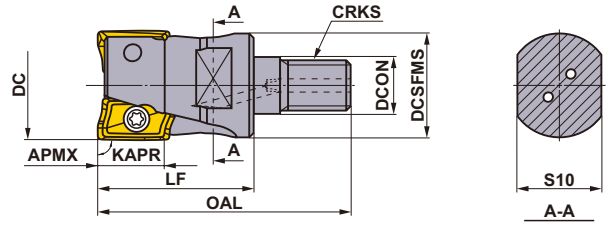

Outil à droite uniquement.

■ FRAISE À EMBOUT FILETÉ

Avec trou de lubrification

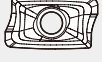

DC (mm)	Référence	Stock R	Nombre de dents	Dimensions (mm)						WT [*] (kg)	APMX (mm)	RMPX	
				DCON	DCSFMS	OAL	LF	S10	CRKS				
25	APX4000R252M12A35	●	2	12.5	23.5	57	35	19	M12	0.2	15	11.0°	AO T18
28	APX4000R282M12A35	●	2	12.5	23.5	57	35	19	M12	0.2	15	9.0°	AO T18
32	APX4000R322M16A40	★	2	17	28.5	63	40	24	M16	0.3	15	7.0°	AO T18
32	APX4000R323M16A40	●	3	17	28.5	63	40	24	M16	0.3	15	7.0°	AO T18
35	APX4000R352M16A40	★	2	17	28.5	63	40	24	M16	0.3	15	6.0°	AO T18
35	APX4000R353M16A40	★	3	17	28.5	63	40	24	M16	0.3	15	6.0°	AO T18
40	APX4000R403M16A40	★	3	17	28.5	63	40	24	M16	0.3	15	6.0°	AO T18
40	APX4000R404M16A40	●	4	17	28.5	63	40	24	M16	0.3	15	6.0°	AO T18

Remarque 1) Lors de l'utilisation de plaquettes avec rayons $RE \geq 3.2\text{mm}$, veuillez usiner le porte-outil comme indiqué à la page K144.

Remarque 2) Pour les attachements à visser, voir page K244.

* WT : Poids de l'outil

PIÈCES DÉTACHÉES

DC (mm)	Porte-outil Type	DC (mm)	Porte-outil Type			
				Vis de fixation	Clé	Anti-grippant
25	APX4000R25	28	APX4000R28	TPS4	TIP15W	MK1KS
32	APX4000R32	35	APX4000R35	TPS4	TIP15W	MK1KS
40	APX4000R40	40	APX4000-040	TPS43	TIP15W	MK1KS
50	APX4000R50	50	APX4000-050	TPS43	TIP15W	MK1KS
63	APX4000R63	63	APX4000-063	TPS43	TIP15W	MK1KS
		80	APX4000-080	TPS43	TIP15W	MK1KS
		100	APX4000-100	TPS43	TIP15W	MK1KS
		125	APX4000-125	TPS43	TIP15W	MK1KS
		160	APX4000-160	TPS43	TIP15W	MK1KS

* Couple de serrage (N • m) : TPS4 = 4,0, TPS43 = 4,0

K

FRAISES À PLAQUETTES

FRAISES À PLAQUETTES

PLAQUETTES

K

FRAISES À PLAQUETTES

Matière	P	Acier	Conditions de coupe (Guide):											Géométrie				
	M	Acier Inoxydable	● : Coupe Stable ● : Coupe Générale † : Coupe Instable															
	K	Fonte	Honing :															
Forme	S	Alliage réfractaire, Alliage titane	MC5020	MP6120	MP6130	MP7130	MP9120	MP9130	VP15TF	VP20RT	Dimensions (mm)					*		
	H	Acier trempé									L	LE	W1	S	BS		RE	
Générale Brise-copeaux M	AOMT184804PEER-M	M	E	●	●	●	●	●	●	●	●	18	15	9	4.8	1.8	0.4	
	AOMT184808PEER-M	M	E	●	●	●	●	●	●	●	●	18	15	9	4.8	1.4	0.8	
	AOMT184810PEER-M	M	E	●	●	●	●	●	●	●	●	18	15	9	4.8	1.0	1.0	
	AOMT184812PEER-M	M	E	●	●	●	●	●	●	●	●	18	15	9	4.8	0.8	1.2	
	AOMT184816PEER-M	M	E	●	●	●	●	●	●	●	●	18	15	9	4.8	0.4	1.6	
	AOMT184820PEER-M	M	E	●	●	●	●	●	●	●	●	18	15	9	4.8	0.4	2.0	
Arête de coupe renforcée Brise-copeaux H	AOMT184804PEER-H	M	E	●	●	●	●	●	●	●	●	18	15	9	4.8	1.8	0.4	
	AOMT184808PEER-H	M	E	●	●	●	●	●	●	●	●	18	15	9	4.8	1.4	0.8	
	AOMT184816PEER-H	M	E	●	●	●	●	●	●	●	●	18	15	9	4.8	0.4	1.6	
	AOMT184832PEER-H	M	E	●	●	●	●	●	●	●	●	18	15	9	4.8	0.4	3.2	
	AOMT184840PEER-H	M	E	●	●	●	●	●	●	●	●	18	15	9	4.8	0.4	4.0	
	AOMT184850PEER-H	M	E	●	●	●	●	●	●	●	●	18	15	9	4.8	-	5.0	
AOMT184864PEER-H	M	E	●	●	●	●	●	●	●	●	18	15	9	4.8	-	6.35		

* Selon l'angle de coupe radial du corps, le rayon R réalisé sur la pièce peut être différent du rayon de plaquette RE.

Note pour l'utilisation des plaquettes à grand rayon

En utilisant une plaquette avec un rayon $RE \geq R3.2mm$, l'usinage du porte-outil en forme de rayon est recommandé, voir ci-contre.

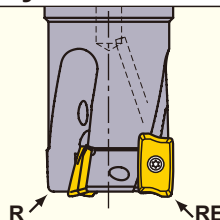

RE (mm)	R (mm)
3.2	2.0
4.0	2.5
5.0	3.5
6.35	5.0

R : Rayon en bout du porte-outil
RE : Rayon plaquette

● : Article stocké.

K144 (10 plaquettes par boîte)

CONDITIONS DE COUPE RECOMMANDÉES

VITESSE DE COUPE

Matière	Dureté	Plaquelette				ae (mm)			
		Priorité de nuance		Brise-copeaux	≤0.25DC	0.25–0.5DC	0.5–0.75DC	DC (rainure)	
		1ère	2nde						Vitesse de coupe Vc (m/min)
P	Acier doux ≤180HB	MP6120	VP15TF	M H	230(180–270)	220(170–260)	180(140–210)	180(140–210)	
		MP6130	VP20RT	M H	200(150–240)	190(140–230)	150(110–180)	150(110–180)	
	Acier carbone Acier allié 180–350HB	MP6120	VP15TF	M H	180(140–210)	170(130–200)	140(110–160)	140(110–160)	
		MP6130	VP20RT	M H	150(110–180)	140(100–170)	110(80–130)	110(80–130)	
M	Acier inoxydable	MP7130	VP20RT	M H	180(140–210)	170(130–200)	140(110–160)	140(110–160)	
K	Fonte grise	MC5020	VP15TF	H –	250(200–300)	240(190–290)	210(160–260)	140(110–160)	
	Fonte ductile	MC5020	VP15TF	H –	130(100–150)	120(90–140)	100(80–120)	100(80–120)	
S	Alliage titane	MP9120	VP15TF	H M	50(40–70)	–	–	50(40–70)	
		MP9130	VP20RT	H M	40(30–60)	–	–	40(30–60)	
	Alliage réfractaire	MP9120	VP15TF	H M	40(30–60)	–	–	40(30–60)	
		MP9130	VP20RT	H M	30(20–40)	–	–	30(20–40)	
H	Acier Traité	VP15TF	–	H –	90(70–100)	85(60–100)	70(50–80)	70(50–80)	

PROFONDEUR DE PASSE ET AVANCE PAR DENT

Matière	Dureté	ae (mm)	Profondeur de Passe ap (mm)	Avance par dent fz (mm/dent)			
				Diamètre fraise DC (mm)			
				ø25–ø40	ø50–ø80	ø100–ø160	
P	Acier doux Acier carbone Acier allié ≤180HB 180–350HB	≤0.5DC	≤5	0.30	0.30	0.25	
			5–7.5	0.25	0.25	0.20	
			7.5–10	0.20	0.20	0.15	
			10–12.5	0.15	0.15	0.10	
			12.5–15	0.10	0.10	0.07	
		0.5–0.75DC	≤5	0.20	0.20	0.15	
			5–10	0.15	0.15	0.10	
			10–15	0.10	0.10	0.07	
		DC (rainure)	≤5	0.15	0.15	0.15	
			5–7.5	0.10	0.10	0.10	
				7.5–10	0.07	0.07	0.07
		M	Acier inoxydable	≤0.5DC	≤5	0.30	0.25
5–7.5	0.25				0.20	0.20	
7.5–10	0.20				0.15	0.15	
10–12.5	0.15				0.10	0.10	
12.5–15	0.10				0.07	0.07	
0.5–0.75DC	≤5			0.20	0.15	0.15	
	5–10			0.15	0.10	0.10	
	10–15			0.10	0.07	0.07	
DC (rainure)	≤5			0.15	0.15	0.15	
	5–7.5			0.10	0.10	0.10	
				7.5–10	0.07	0.07	0.07
K	Fonte grise			≤0.5DC	≤5	0.30	0.30
		5–7.5	0.25		0.25	0.20	
		7.5–10	0.20		0.20	0.15	
		10–12.5	0.15		0.15	0.10	
		12.5–15	0.10		0.10	0.07	
		0.5–0.75DC	≤5	0.20	0.20	0.15	
			5–10	0.15	0.15	0.10	
			10–15	0.10	0.10	0.07	
		DC (rainure)	≤5	0.15	0.15	0.15	
			5–7.5	0.10	0.10	0.10	
				7.5–10	0.07	0.07	0.07
		Fonte ductile	Résistance à la traction ≤800MPa	≤0.5DC	≤5	0.25	0.25
	5–7.5				0.20	0.20	0.20
	7.5–10				0.15	0.15	0.15
	10–12.5				0.10	0.10	0.10
	12.5–15				0.07	0.07	0.07
	0.5–0.75DC			≤5	0.20	0.20	0.15
	DC (rainure)	5–10	0.15	0.15	0.10		
10–15		0.10	0.10	0.07			
		≤5	0.15	0.15	0.15		
		5–7.5	0.10	0.10	0.10		
		7.5–10	0.07	0.07	0.07		

K

FRAISES À PLAQUETTES

FRAISES À PLAQUETTES

CONDITIONS DE COUPE RECOMMANDÉES PROFONDEUR DE PASSE ET AVANCE PAR DENT

Matière	Dureté	ae (mm)	Profondeur de Passe ap (mm)	Avance par dent fz (mm/dent)		
				Diamètre fraise DC (mm)		
				ø25–ø40	ø50–ø80	ø100–ø160
S Alliage titane	≤350HB	≤0.25DC	≤5	0.15	0.10	0.10
			5–7.5	0.10	0.05	0.05
			7.5–10	0.05	–	–
		DC (rainure)	≤5	0.05	0.05	0.05
Alliage réfractaire	–	≤0.25DC	≤2	0.10	0.05	0.05
		DC (rainure)	≤1	0.05	0.05	0.05
H Acier trempé	40–55HRC	≤0.25DC	≤5	0.15	0.15	0.15
			5–7.5	0.10	0.10	0.10
			7.5–10	0.07	0.07	0.07
		0.25–0.5DC	≤5	0.10	0.10	0.10
			5–7.5	0.07	0.07	0.07
		0.5–0.75DC	≤5	0.07	0.07	0.07
DC (rainure)	≤5	0.07	0.07	0.07		

Remarque 1) Ces conditions de coupe sont un guide pour les attachements standards et par alésage.

Ajuster en fonction des conditions d'usinage.

Remarque 2) Les vibrations peuvent survenir dans certains cas. Réduire la profondeur de passe et / ou réduire les conditions de coupe dans les cas suivants:

- Quand on utilise un attachement long.
- Quand il y a un long porte-à-faux avec un attachement standard ou à alésage.
- Quand il y a des applications avec un mauvais serrage ou quand on utilise une machine de faible rigidité.

Remarque 3) Dans le cas de fraise à pas large ou à pas fin, le pas large est recommandé pour prévenir des vibrations.

Remarque 4) Le brise-copeaux H est la première recommandation pour une coupe fortement interrompue et instable.

K
FRAISES À PLAQUETTES

■ RAMPING / INTERPOLATION HÉLIOÏDALE

● RAMPING

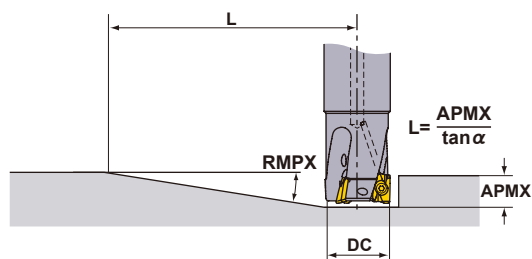

● INTERPOLATION HÉLIOÏDALE

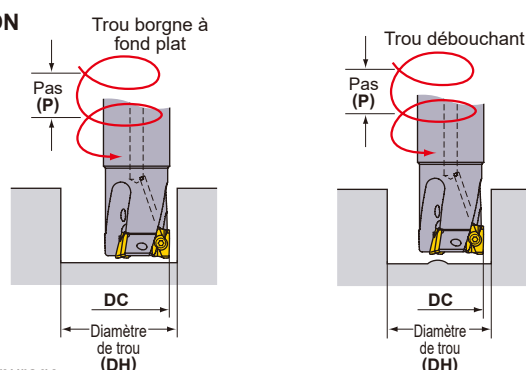

Se référer au tableau ci-dessous pour les conditions de coupe.

Pour l'avance par dent et la vitesse de coupe, se référer aux conditions de coupe pour rainurage.

Diamètre de l'arête de coupe DC (mm)	Ramping		Interpolation Hélicoïdale (Trou borgne à fond plat)				Interpolation Hélicoïdale (Trou débouchant)	
	Angle max. de ramping RMPX	Distance minimum *1 L (mm)	Diamètre de trou maximum DH max. (mm)	Pas maximum P max. (mm)	Diamètre de trou minimum DH min. (mm)	Pas maximum P max. (mm)	Diamètre de trou minimum DH min. (mm)	Pas maximum P max. (mm)
25	11°	85	48	14	45	12	32	4
28	9°	105	54	12	51	11	38	4
32	7°	135	62	11	59	10	46	5
35	6°	158	68	10	65	9	52	5
40	6°	158	78	12	75	11	62	7
50	4°	238	98	10	95	9	82	7
63	3°	318	124	10	121	9	108	7
80	2°	477	158	8	155	8	142	6
100	1.5°	636	198	8	195	7	182	6
125	1°	954	248	6	245	6	232	5
160	1°	954	318	8	315	8	302	7

Remarque 1) L'usinage de matières ductiles aux angles de ramping ci-dessus peut donner lieu à la génération de copeaux continus.

Dans ce cas, nous recommandons de réduire l'angle de ramping ou l'avance à la dent.

*1 L = 15 / tan(α). Distance de déplacement des fraises jusqu'à atteindre une profondeur de coupe de 10 mm à l'angle de ramping maximum.

*2 Pour un rayon de pointe de 0,8 mm. Si l'angle est différent, utilisez la formule suivante.

$$\{(\text{diamètre d'arête de coupe DC}) - (\text{rayon de pointe}) - 0,2\} \times 2$$

FRAISES À SURFACER-DRESSER



APX3000

HÉRISSON

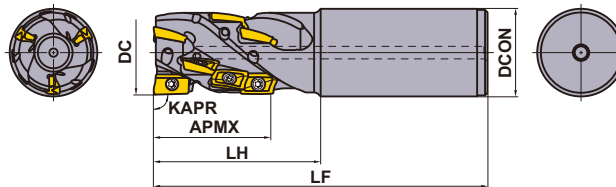
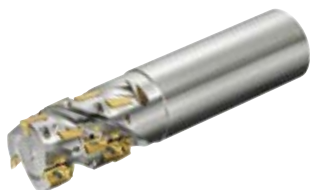

Outil à droite uniquement.

K

FRAISES À PLAQUETTES

■ ATTACHEMENT CYLINDRIQUE

DC (mm)	Référence	Stock R	Trou d'arrosage	Nbre goujures	Total	Dimensions (mm)			WT* (kg)	APMX (mm)	Type Plaquette
						DCON	LF	LH			
20	APX3KR2004SN20S028A	★	—	1	4	20	125	45	0.27	28	AO-T12
25	APX3KR2506SA25S028A	●	○	2	6	25	125	45	0.40	28	AO-T12
25	APX3KR2508SA25M037A	●	○	2	8	25	130	50	0.41	37	AO-T12
32	APX3KR3208SA32S037A	★	○	2	8	32	130	50	0.70	37	AO-T12
32	APX3KR3210SA32M046A	★	○	2	10	32	140	60	0.74	46	AO-T12
32	APX3KR3212SA32S037A	★	○	3	12	32	130	50	0.67	37	AO-T12
32	APX3KR3215SA32M046A	★	○	3	15	32	140	60	0.71	46	AO-T12
40	APX3KR4015SA42S046A	★	○	3	15	42	140	60	1.24	46	AO-T12
40	APX3KR4018SA42M055A	★	○	3	18	42	150	70	1.31	55	AO-T12

Remarque 1) Lors de l'utilisation de plaquettes avec rayons $RE \geq 2.4\text{mm}$, veuillez usiner le porte-outil comme indiqué à la page K149.

Remarque 2) Le rayon RE doit être inférieur ou égal à 0,8 mm, sauf pour la rangée de plaquettes au bout de la fraise.

* WT : Poids de l'outil

PIÈCES DÉTACHÉES

DC (mm)	Référence porte-outil	*		
		Vis de serrage	Clé	Anti-grippant
20	APX3KR20	TPS25	TIP07F	MK1KS
25	APX3KR25	TPS25-1	TIP07F	MK1KS
32	APX3KR32	TPS25-1	TIP07F	MK1KS
40	APX3KR40	TPS25-1	TIP07F	MK1KS
40	APX3K-040	TPS25-1	TIP07F	MK1KS
50	APX3K-050	TPS25-1	TIP07F	MK1KS

* Couple de serrage (N • m) : TPS25 = 1,0, TPS25-1 = 1,0

● : Article stocké. ★ : Article standard Japon.

PIÈCES DÉTACHÉES > N001
DONNÉES TECHNIQUES > P001

K147

FRAISES À PLAQUETTES

K

FRAISES À PLAQUETTES

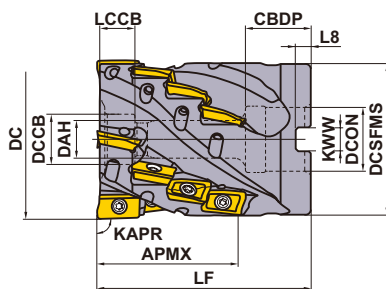

Outil à droite uniquement.

DC (mm)	Vis d'attachement	Géométrie
40	HSC08040	
50	HSC10045	

FRAISE à ALÉSAGE

Avec trou de lubrification

KAPR : 90°
GAMP : +12° GAMF : +6°

DC (mm)	Référence	Stock	Nbre goujures	Total	Dimensions (mm)		WT* (kg)	APMX (mm)	Type Plaquette
					LF	DCON			
40	APX3K-040A16A037RA	★	4	16	50	16	0.25	37	AO-T12
50	APX3K-050A20A046RA	★	4	20	60	22	0.54	46	AO-T12

Remarque 1) Lors de l'utilisation de plaquettes avec rayons $RE \geq 2.4\text{mm}$, veuillez usiner le porte-outil comme indiqué à la page K149.

Remarque 2) Le rayon RE doit être inférieur ou égal à 0,8 mm, sauf pour la rangée de plaquettes au bout de la fraise.

Remarque 3) L'arrosage doit passer par la face frontale du tenon de centrage de l'attachement. Il n'est pas possible d'utiliser des vis d'attachement percées.

* WT : Poids de l'outil





DIMENSIONS DE MONTAGE

DC (mm)	Référence	Dimensions (mm)							
		DCON	CBDP	DAH	DCCB	LCCB	DCSFMS	KWW	L8
40	APX3K-040A16A037RA	16	18	9	14	9.9	38.5	8.4	5.6
50	APX3K-050A20A046RA	22	20	11	17	11.9	48.4	10.4	6.3

● : Article stocké. ★ : Article standard Japon.

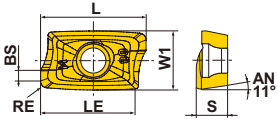
(10 plaquettes par boîte)

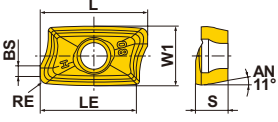
PLAQUETTES

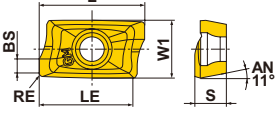
Matière	P	Acier																Conditions de coupe (Guide): ● : Coupe Stable ● : Coupe Générale ✚ : Coupe Instable Honing : E : Ronde F : Affûtée							
	M	Acier Inoxydable																							
	K	Fonte																							
Matière	N	Non ferreux																							
	S	Alliage réfractaire, Alliage titane																							
Matière	H	Acier trempé																							
Forme	Référence	Classe	Honing	Revêtu										Carbure	Dimensions (mm)						Géométrie				
				MC5020	MP6120	MP6130	MP7130	MP9120	MP9130	VP15TF	VP20RT	TF15	L	LE	W1	S	BS	RE	*						
Générale Brise-copeaux M 	AOMT123602PEER-M	M	E																12	10	6.6	3.6	1.8	0.2	
	AOMT123604PEER-M	M	E																12	10	6.6	3.6	1.6	0.4	
	AOMT123608PEER-M	M	E																12	10	6.6	3.6	1.2	0.8	
	AOMT123610PEER-M	M	E																12	10	6.6	3.6	1.0	1.0	
	AOMT123612PEER-M	M	E																12	10	6.6	3.6	0.8	1.2	
	AOMT123616PEER-M	M	E																12	10	6.6	3.6	0.4	1.6	
	AOMT123620PEER-M	M	E																12	10	6.6	3.6	0.4	2.0	
	AOMT123624PEER-M	M	E																12	10	6.6	3.6	0.4	2.4	
	AOMT123630PEER-M	M	E																12	10	6.6	3.6	0.4	3.0	
AOMT123632PEER-M	M	E																12	10	6.6	3.6	0.4	3.2		
Arête de coupe renforcée Brise-copeaux H 	AOMT123604PEER-H	M	E															12	10	6.6	3.6	1.6	0.4		
	AOMT123608PEER-H	M	E															12	10	6.6	3.6	1.2	0.8		
	AOMT123616PEER-H	M	E															12	10	6.6	3.6	0.4	1.6		
Pour l'usinage des alliages d'aluminium Brise-copeaux GM 	AOGT123602PEFR-GM	G	F															12	10	6.6	3.6	1.8	0.2		
	AOGT123604PEFR-GM	G	F															12	10	6.6	3.6	1.6	0.4		
	AOGT123608PEFR-GM	G	F															12	10	6.6	3.6	1.2	0.8		

* Selon l'angle de coupe radial du corps, le rayon R réalisé sur la pièce peut être différent du rayon de plaquette RE.

Note pour l'utilisation des plaquettes à grand rayon

En utilisant une plaquette avec un rayon $RE \geq R_{2.4mm}$, l'usinage du porte-outil en forme de rayon est recommandé, voir ci-contre.

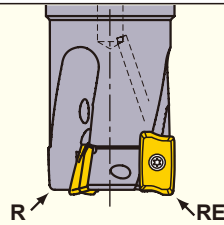

RE (mm)	R (mm)
2.4	1.9
3.0	2.5
3.2	2.7

R : Rayon en bout du porte-outil
RE : Rayon plaquette

FRAISES À PLAQUETTES

CONDITIONS DE COUPE RECOMMANDÉES

■ VITESSE DE COUPE

Matière	Plaquette			ae (mm)		
	Priorité de nuance		Brise-Copeaux	≤0.25DC	0.25-0.75DC	DC (rainure)
	1ère	2nde				
P Acier doux Acier carbone acier allié, acier outil Acier pré-traité	MP6120	VP15TF	M H	180(140-220)	150(110-180)	120(100-140)
	MP6130	VP20RT	M H	160(120-200)	130(100-160)	100(80-120)
	MP6120	VP15TF	M H	150(100-200)	120(90-150)	100(80-120)
	MP6130	VP20RT	M H	130(90-170)	90(70-110)	80(60-100)
	MP6120	VP15TF	M H	120(80-160)	100(70-130)	90(50-120)
	MP6130	VP20RT	M H	100(70-130)	90(60-120)	70(50-100)
M Acier inoxydable	MP7130	—	M —	150(120-180)	120(100-140)	100(80-120)
K Fonte grise Fonte ductile	MC5020	—	H —	200(150-250)	180(150-210)	—
	VP15TF	—	M H	180(120-240)	150(100-200)	100(60-140)
	VP15TF	—	M H	160(120-200)	140(100-180)	80(60-100)
N Alliage aluminium	TF15	MP9120	GM M	400(200-800)	400(200-800)	400(200-800)
S Alliage titane Alliage réfractaire	MP9130	—	M —	40(30-60)	—	40(30-60)
	MP9120	—	M —	50(40-70)	—	50(40-70)
	MP9120	VP15TF	M H	40(30-60)	—	40(30-60)
	MP9130	VP20RT	M H	30(20-40)	—	30(20-40)

■ PROFONDEUR DE PASSE / AVANCE PAR DENT

Matière	Caratéristiques	ae	DC (mm)					
			ø20		ø25		ø32-ø50	
			ap	fz (mm/dent)	ap	fz (mm/dent)	ap	fz (mm/dent)
P Acier doux Acier carbone Acier allié Acier outil Acier pré-traité	≤180HB	≤0.25DC	≤28	0.15	≤37	0.17	≤55	0.2
		0.25-0.75DC	≤28	0.12	≤37	0.15	≤55	0.17
		DC (rainure)	≤18	0.08	≤18	0.08	≤18	0.08
	180-280HB	≤0.25DC	≤28	0.12	≤37	0.15	≤55	0.17
		0.25-0.75DC	≤28	0.1	≤37	0.12	≤55	0.15
		DC (rainure)	≤18	0.08	≤18	0.08	≤18	0.08
	≤350HB (Recuit)	≤0.25DC	≤28	0.12	≤37	0.15	≤55	0.17
		0.25-0.75DC	≤28	0.1	≤37	0.12	≤55	0.15
		DC (rainure)	≤18	0.08	≤18	0.08	≤18	0.08
	35-45HRC	≤0.25DC	≤28	0.12	≤37	0.15	≤55	0.17
		0.25-0.75DC	≤28	0.1	≤37	0.12	≤55	0.15
		DC (rainure)	≤18	0.08	≤18	0.08	≤18	0.08
M Aciers inoxydables ferritiques et martensitiques Acier inoxydable duplex Acier inoxydable à durcisse- ment structural	—	≤0.25DC	≤28	0.12	≤37	0.15	≤55	0.17
		0.25-0.75DC	≤28	0.1	≤37	0.12	≤55	0.15
		DC (rainure)	≤18	0.08	≤18	0.08	≤18	0.08
	≤280HB	≤0.25DC	≤28	0.12	≤37	0.15	≤55	0.17
		0.25-0.75DC	≤28	0.1	≤37	0.12	≤55	0.15
		DC (rainure)	≤18	0.08	≤18	0.08	≤18	0.08
	<450HB	≤0.25DC	≤28	0.12	≤37	0.15	≤55	0.17
		0.25-0.75DC	≤28	0.1	≤37	0.12	≤55	0.15
		DC (rainure)	≤18	0.08	≤18	0.08	≤18	0.08
K Fonte grise Fonte ductile	Résistance à la traction ≤350MPa	≤0.25DC	≤28	0.15	≤37	0.17	≤55	0.2
		0.25-0.75DC	≤28	0.12	≤37	0.15	≤55	0.17
		DC (rainure)	≤18	0.1	≤18	0.1	≤18	0.1
	Résistance à la traction ≤800MPa	≤0.25DC	≤28	0.12	≤37	0.15	≤55	0.17
		0.25-0.75DC	≤28	0.1	≤37	0.12	≤55	0.15
		DC (rainure)	≤18	0.08	≤18	0.08	≤18	0.08
N Alliage aluminium	—	≤0.25DC	≤28	0.15	≤37	0.17	≤55	0.2
		0.25-0.75DC	—	—	≤9	0.17	≤9	0.2
		DC (rainure)	—	—	≤9	0.17	≤9	0.2
S Alliage titane Alliage réfractaire	≤350HB	≤0.25DC	≤28	0.1	≤37	0.1	≤55	0.1
		0.25-0.75DC	—	—	—	—	—	—
		DC (rainure)	≤18	0.06	≤18	0.06	≤18	0.06
	—	≤0.25DC	≤28	0.08	≤37	0.08	≤55	0.08
		0.25-0.75DC	—	—	—	—	—	—
		DC (rainure)	≤18	0.05	≤18	0.05	≤18	0.05

Remarque 1) Les recommandations de données de coupe indiquées ci-dessus sont des valeurs générales initiales pour des machines et des pièces de grande rigidité. En cas de vibrations, veuillez adapter les données de coupe en conséquence.

FRAISES À SURFACER-DRESSER

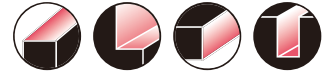

APX4000

HÉRISSON



Fig.1

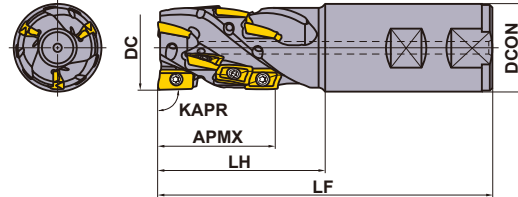
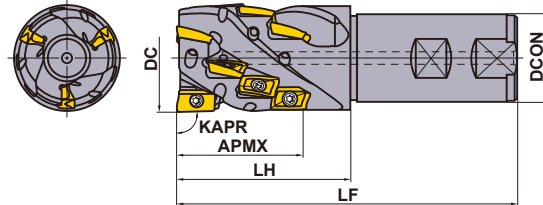

Fig.2



ATTACHEMENT CYLINDRIQUE

KAPR : 90°
Avec trou de lubrification

Outil à droite uniquement.

DC (mm)	Référence	Stock R	Nbre goujures	Total	Dimensions (mm)			WT* (kg)	APMX (mm)	Fig.	Type Plaquette
					DCON	LF	LH				
40	APX4KR4008WA40S056A	●	2	8	40	150	80	1.54	56	1	AO T18
40	APX4KR4012WA40S056A	●	3	12	40	150	80	1.54	56	1	AO T18
50	APX4KR5012WA40S056A	●	3	12	40	150	80	1.76	56	2	AO T18
50	APX4KR5018WA40M084A	●	3	18	40	180	110	2.18	84	2	AO T18

Remarque 1) Lors de l'utilisation de plaquettes avec rayons $RE \geq 3.2$, veuillez usiner le porte-outil comme indiqué à la page K153.
Remarque 2) Seuls les rayons de 0.4 mm et 0.8 mm doivent être utilisés pour les plaquettes en périphérie, pour celles du bout de fraise, utiliser le rayon que l'on veut.

* WT : Poids de l'outil

PIÈCES DÉTACHÉES

	*		
Vis de serrage		Clé	Anti-grippant
TPS43		TIP15W	MK1KS

* Couple de serrage TPS43 : 4,0 Nm

K

FRAISES À PLAQUETTES

● : Article stocké.

PIÈCES DÉTACHÉES > N001
DONNÉES TECHNIQUES > P001

K151

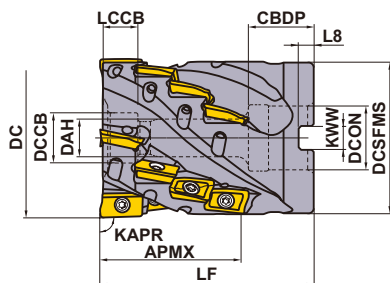

Outil à droite uniquement.

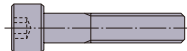
DC (mm)	Vis d'attachement	Géométrie
50	HSC10050	
63	HSC12070	

■ FRAISE à ALÉSAGE

Avec trou de lubrification

 KAPR : 90°
 GAMP : +12° GAMP : +6°

DC (mm)	Référence	Stock R	Nbre goujures	Total	Dimensions (mm)		WT* (kg)	APMX (mm)	 Type Plaque
					LF	DCON			
50	APX4K-050A09A042RA	●	3	9	65	22	0.75	42	AO T18
63	APX4K-063A16A056RA	●	4	16	85	27	1.63	56	AO T18

 Remarque 1) Lors de l'utilisation de plaquettes avec rayons $RE \geq 3.2$, veuillez usiner le porte-outil comme indiqué à la page K153.

Remarque 2) Seuls les rayons de 0.4 mm et 0.8 mm doivent être utilisés pour les plaquettes en périphérie, pour celles du bout de fraise, utiliser le rayon que l'on veut.

Remarque 3) L'arrosage doit passer par la face frontale du tenon de centrage de l'attachement. Il n'est pas possible d'utiliser des vis d'attachement percées.

* WT : Poids de l'outil



DIMENSIONS DE MONTAGE

DC (mm)	Référence	Dimensions (mm)							
		DCON	CBDP	DAH	DCCB	LCCB	DCSFMS	KWW	L8
50	APX4K-050A09A042RA	22	22	11	17	12.5	48	10.4	6.3
63	APX4K-063A16A056RA	27	28	13	20	14	60.7	12.4	7

● : Article stocké.

(10 plaquettes par boîte)

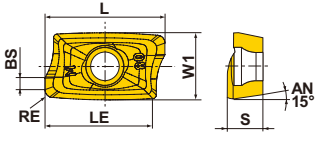
PLAQUETTES

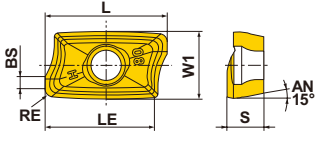
Matière	P	Acier		Conditions de coupe (Guide):															
	M	Acier Inoxydable		● : Coupe Stable	● : Coupe Générale	⊕ : Coupe Instable													
K	Fonte	Honing :																	
S	Alliage réfractaire, Alliage titane	E : Ronde																	
H	Acier trempé																		
Forme	Référence	Classe	Honing	Revêtu							Dimensions (mm)						Géométrie		
				MC5020	MP6120	MP6130	MP7130	MP9120	MP9130	VP15TF	VP20RT	L	LE	W1	S	BS		RE	*
Générale Brise-copeaux M 	AOMT184804PEER-M	M	E	●	●	●	●	●	●	●	●	18	15	9	4.8	1.8	0.4		
	AOMT184808PEER-M	M	E	●	●	●	●	●	●	●	●	18	15	9	4.8	1.4	0.8		
	AOMT184810PEER-M	M	E	●				●	●	●	●	●	18	15	9	4.8	1.0		1.0
	AOMT184812PEER-M	M	E	●				●	●	●	●	●	18	15	9	4.8	0.8		1.2
	AOMT184816PEER-M	M	E	●	●	●	●	●	●	●	●	●	18	15	9	4.8	0.4		1.6
	AOMT184820PEER-M	M	E	●				●	●	●	●	●	18	15	9	4.8	0.4		2.0
Arête de coupe renforcée Brise-copeaux H 	AOMT184804PEER-H	M	E	●	●	●	●	●	●	●	●	18	15	9	4.8	1.8	0.4		
	AOMT184808PEER-H	M	E	●	●	●	●	●	●	●	●	18	15	9	4.8	1.4	0.8		
	AOMT184816PEER-H	M	E	●	●	●	●	●	●	●	●	●	18	15	9	4.8	0.4		1.6
	AOMT184832PEER-H	M	E			●	●						18	15	9	4.8	0.4		3.2
	AOMT184840PEER-H	M	E			●	●						18	15	9	4.8	0.4		4.0
	AOMT184850PEER-H	M	E			●	●						18	15	9	4.8	-		5.0
AOMT184864PEER-H	M	E			●	●						18	15	9	4.8	-	6.35		

* Selon l'angle de coupe radial du corps, le rayon R réalisé sur la pièce peut être différent du rayon de plaquette RE.

Note pour l'utilisation des plaquettes à grand rayon

En utilisant une plaquette avec un rayon $RE \geq R3.2mm$, l'usinage du porte-outil en forme de rayon est recommandé, voir ci-contre.

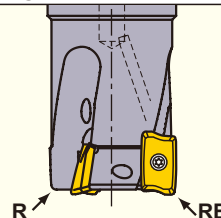

RE (mm)	R (mm)
3.2	2.0
4.0	2.5
5.0	3.5
6.35	5.0

R : Rayon en bout du porte-outil
RE : Rayon plaquette

K

FRAISES À PLAQUETTES

FRAISES À PLAQUETTES

CONDITIONS DE COUPE RECOMMANDÉES

■ VITESSE DE COUPE

Matière	Dureté	Plaquette				Largeur de coupe ae (mm)		
		Nuance		Brise-copeaux	≤0.15DC	0.15–0.3DC	DC (rainure)	
		1ère préconisation	2nde préconisation					
Vitesse de coupe Vc (m/min)								
P	Acier doux	≤180HB	MP6120	VP15TF	M H	200(160–250)	160(120–200)	140(120–160)
			MP6130	VP20RT	M H	170(130–220)	130(90–170)	110(90–130)
M	Acier carbone Acier allié	180–350HB	MP6120	VP15TF	M H	160(120–200)	120(100–140)	100(80–120)
			MP6130	VP20RT	M H	130(90–170)	90(70–110)	70(50–90)
M	Acier inoxydable	≤270HB	MP7130	VP15TF	M H	160(120–200)	120(100–140)	100(80–120)
K	Fonte grise	≤350MPa	MC5020	VP15TF	H –	230(180–280)	190(140–240)	190(140–240)
	Fonte ductile	≤800MPa	MC5020	VP15TF	H –	190(140–220)	170(120–220)	170(120–220)
S	Alliage titane	≤350HB	MP9120	VP15TF	H M	50(40–70)	–	50(40–70)
			MP9130	VP20RT	H M	40(30–60)	–	40(30–60)
	Alliage réfractaire	–	MP9120	VP15TF	H M	40(30–60)	–	40(30–60)
			MP9130	VP20RT	H M	30(20–40)	–	30(20–40)

■ PROFONDEUR DE PASSE ET AVANCE PAR DENT

Matière	Caratéristiques	Largeur de coupe ae (mm)	Profondeur de Passe ap (mm)	Avance par dent fz (mm/dent)			
				Diamètre fraise DC (mm)			
				ø40 Longueur de coupe 56mm ø50 Longueur de coupe 42mm	ø50 Longueur de coupe 56mm ø63 Longueur de coupe 56mm	ø50 Longueur de coupe 84mm	
P	Acier doux	≤180HB	≤0.3DC	≤20	0.25	0.25	0.20
				20–50	0.20	0.20	0.15
			50–80	–	–	0.10	
			DC (rainure)	≤20	0.20	0.20	0.15
	Acier carbone Acier allié	180–350HB	≤0.3DC	≤20	0.25	0.25	0.20
				20–50	0.20	0.20	0.15
			50–80	–	–	0.10	
			DC (rainure)	≤20	0.15	0.15	0.10
M	Acier inoxydable	≤270HB	≤0.3DC	≤20	0.25	0.25	0.20
				20–50	0.20	0.20	0.15
K	Fonte grise	Résistance à la traction ≤350MPa	≤0.15DC	≤10	0.30	0.30	0.25
				10–50	0.25	0.25	0.20
			50–80	–	–	0.15	
			0.15–0.3DC	≤10	0.25	0.25	0.20
				10–50	0.20	0.20	0.15
			50–80	–	–	0.10	
	DC (rainure)	≤10	0.25	0.25	0.20		
		10–50	0.20	0.20	0.15		
	Fonte ductile	Résistance à la traction ≤800MPa	≤0.15DC	≤20	0.25	0.25	0.20
				20–50	0.20	0.20	0.15
			50–80	–	–	0.10	
			0.15–0.3DC	≤20	0.20	0.20	0.15
20–50				0.15	0.15	0.10	
50–80			–	–	0.07		
DC (rainure)	≤10	0.15	0.15	0.10			
	10–50	0.10	0.10	–			
S	Alliage titane	≤350HB	≤0.15DC	≤20	0.10	0.10	–
				20–50	0.10	0.10	–
	Alliage réfractaire	–	≤0.15DC	≤50	0.08	0.08	–
				DC (rainure)	≤10	0.07	0.07
Alliage réfractaire	–	DC (rainure)	≤10	0.07	0.07	–	
			≤20	0.05	0.05	–	

Remarque 1) Les recommandations de données de coupe indiquées ci-dessus sont des valeurs générales initiales pour des machines et des pièces de grande rigidité. En cas de vibrations, veuillez adapter les données de coupe en conséquence.

FRAISES MULTI FONCTIONS <ALUMINIUM ET TITANE>

90°
KAPR

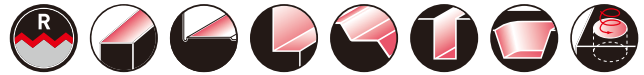

AXD4000

P M K **N** S H

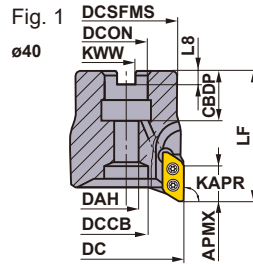

Fig. 2

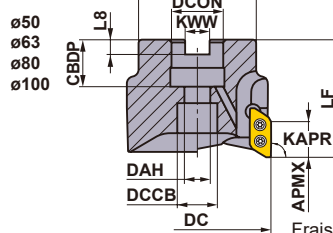
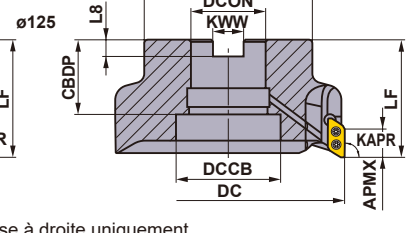

Fig. 3



Fraise à droite uniquement.

ATTACHEMENT PAR ALÉSAGE

KAPR : 90°

GAMP : +14° - 15° GAMF : +21° - +26°

Diamètre fraise DC (mm)	Vis d'attachement	Géométrie		
φ40	HFF08043H	①	①	③
φ50, φ63	HSC10030H	②	②	③
φ80	HSC12035H	②	②	③
φ100	HSC16040H	②	②	③
φ125	MBA20040H	③	③	③

Type	Rejon plaquette RE	Référence	Stock R	Nombre de dents	Dimensions (mm)								WT *2 (kg)	APMX (mm)	Vitesse de rotation maxi. recommandée (min ⁻¹)	Fig.	Vis de serrage	Clé	Anti-grippant	Plaquette	
					DC	LF	DCON	CBDP	DAH	DCSFMS	KWW	L8									DCCB
Type A	0.4 3.2	AXD4000-040A02RA	★	2	40	50	16	18	8.5	34	8.4	5.6	12	0.3	15.5	41000	1	TS3SB	TKY08D	MK1KS	XDGX1750
		AXD4000-040A03RA	●	3	40	50	16	18	8.5	34	8.4	5.6	12	0.3	15.5	41000	1	TS3SB	TKY08D	MK1KS	
		AXD4000-050A02RA	★	2	50	50	22	20	11	45	10.4	6.3	17	0.4	15.5	35000	2	TS3SB	TKY08D	MK1KS	
		AXD4000-050A04RA	●	4	50	50	22	20	11	45	10.4	6.3	17	0.4	15.5	35000	2	TS3SB	TKY08D	MK1KS	
		AXD4000-063A05RA	●	5	63	50	22	20	11	50	10.4	6.3	17	0.6	15.5	30000	2	TS3SB	TKY08D	MK1KS	
		AXD4000-080A05RA	●	5	80	50	27	23	13	60	12.4	7	20	1	15.5	27000	2	TS3SB	TKY08D	MK1KS	
		AXD4000-100A06RA	●	6	100	63	32	26	17	78	14.4	8	26	2	15.5	23000	2	TS3SB	TKY08D	MK1KS	
AXD4000-125B07RA	●	7	125	63	40	40	—	90	16.4	9	56	2.8	15.5	20000	3	TS3SB	TKY08D	MK1KS			
Type B	4.0 5.0	AXD4000-040A02RB	★	2	40	50	16	18	8.5	34	8.4	5.6	12	0.3	14.8	41000	1	TS3SB	TKY08D	MK1KS	
		AXD4000-040A03RB	●	3	40	50	16	18	8.5	34	8.4	5.6	12	0.3	14.8	41000	1	TS3SB	TKY08D	MK1KS	
		AXD4000-050A02RB	★	2	50	50	22	20	11	45	10.4	6.3	17	0.4	14.8	35000	2	TS3SB	TKY08D	MK1KS	
		AXD4000-050A04RB	●	4	50	50	22	20	11	45	10.4	6.3	17	0.4	14.8	35000	2	TS3SB	TKY08D	MK1KS	
		AXD4000-063A05RB	●	5	63	50	22	20	11	50	10.4	6.3	17	0.6	14.8	30000	2	TS3SB	TKY08D	MK1KS	
		AXD4000-080A05RB	●	5	80	50	27	23	13	60	12.4	7	20	1	14.8	27000	2	TS3SB	TKY08D	MK1KS	
		AXD4000-100A06RB	●	6	100	63	32	26	17	78	14.4	8	26	2	14.8	23000	2	TS3SB	TKY08D	MK1KS	
AXD4000-125B07RB	●	7	125	63	40	40	—	90	16.4	9	56	2.8	14.8	20000	3	TS3SB	TKY08D	MK1KS			

Remarque 1) La vitesse de rotation maximum est indiquée pour garantir la stabilité de l'outil et de la plaquette.

Avant d'utiliser l'outil, veuillez lire les consignes en page K168.

Remarque 2) Lorsque vous utilisez l'outil avec des vitesses de broche élevées, faire en sorte que l'outil et le porte-outil de fraisage soient correctement équilibrés.

Remarque 3) Plaquettes avec un rayon de 1.6mm ou plus : lorsque le rayon de pointe augmente, les dimensions LF et LH diminuent.

*1 Couple de serrage (N • m) : TS3SB=1,5

Lors du changement de plaquette, il est préconisé de changer également les vis de plaquettes.

*2 WT : Poids de l'outil

● : Article stocké. ★ : Article standard Japon.

PIÈCES DÉTACHÉES > N001
DONNÉES TECHNIQUES > P001

K155

K

FRAISES À PLAQUETTES

FRAISES À PLAQUETTES

K
FRAISES À PLAQUETTES



Fig.1

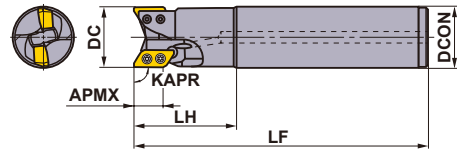
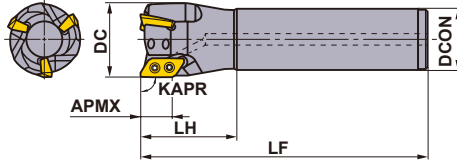

Fig.2



Fraise à droite uniquement.

ATTACHEMENT CYLINDRIQUE

KAPR :90°

Type	Rayon plaquette	Référence	Stock	Nombre de dents	Dimensions (mm)				APMX (mm)	Vitesse de rotation maxi. recommandée (min ⁻¹)	Fig.	* 			
					DC	LF	LH	DCON							
Type A	0.4 3.2	AXD4000R201SA20SA	●	1	20	110	35	20	15.5	15000	1	TS3SBS	TKY08D	MK1KS	XDGX1750
		AXD4000R252SA25SA	●	2	25	125	50	25	15.5	49000	1	TS3SB	TKY08D	MK1KS	
		AXD4000R252SA25LA	●	2	25	170	80	25	15.5	49000	1	TS3SB	TKY08D	MK1KS	
		AXD4000R282SA25SA	●	2	28	125	50	25	15.5	48500	2	TS3SB	TKY08D	MK1KS	
		AXD4000R282SA25ELA	●	2	28	220	50	25	15.5	48500	2	TS3SB	TKY08D	MK1KS	
		AXD4000R322SA32SA	●	2	32	150	50	32	15.5	48000	1	TS3SB	TKY08D	MK1KS	
		AXD4000R322SA32LA	●	2	32	200	80	32	15.5	48000	1	TS3SB	TKY08D	MK1KS	
		AXD4000R352SA32SA	●	2	35	150	50	32	15.5	45000	2	TS3SB	TKY08D	MK1KS	
		AXD4000R352SA32ELA	★	2	35	250	50	32	15.5	45000	2	TS3SB	TKY08D	MK1KS	
		AXD4000R403SA32SA	●	3	40	150	50	32	15.5	41000	2	TS3SB	TKY08D	MK1KS	
		AXD4000R403SA42SA	★	3	40	170	80	42	15.5	41000	1	TS3SB	TKY08D	MK1KS	
		AXD4000R403SA32ELA	★	3	40	250	50	32	15.5	41000	2	TS3SB	TKY08D	MK1KS	
Type B	4.0 5.0	AXD4000R201SA20SB	●	1	20	110	35	20	14.8	15000	1	TS3SBS	TKY08D	MK1KS	
		AXD4000R252SA25SB	●	2	25	125	50	25	14.8	49000	1	TS3SB	TKY08D	MK1KS	
		AXD4000R252SA25LB	●	2	25	170	80	25	14.8	49000	1	TS3SB	TKY08D	MK1KS	
		AXD4000R282SA25SB	★	2	28	125	50	25	14.8	48500	2	TS3SB	TKY08D	MK1KS	
		AXD4000R282SA25ELB	●	2	28	220	50	25	14.8	48500	2	TS3SB	TKY08D	MK1KS	
		AXD4000R322SA32SB	●	2	32	150	50	32	14.8	48000	1	TS3SB	TKY08D	MK1KS	
		AXD4000R322SA32LB	●	2	32	200	80	32	14.8	48000	1	TS3SB	TKY08D	MK1KS	
		AXD4000R352SA32SB	★	2	35	150	50	32	14.8	45000	2	TS3SB	TKY08D	MK1KS	
		AXD4000R352SA32ELB	●	2	35	250	50	32	14.8	45000	2	TS3SB	TKY08D	MK1KS	
		AXD4000R403SA32SB	●	3	40	150	50	32	14.8	41000	2	TS3SB	TKY08D	MK1KS	
		AXD4000R403SA42SB	★	3	40	170	80	42	14.8	41000	1	TS3SB	TKY08D	MK1KS	
		AXD4000R403SA32ELB	★	3	40	250	50	32	14.8	41000	2	TS3SB	TKY08D	MK1KS	

Remarque 1) La vitesse de rotation maximum est indiquée pour garantir la stabilité de l'outil et de la plaquette.

Avant d'utiliser l'outil, veuillez lire les consignes en page K168.

Remarque 2) Lorsque vous utilisez l'outil avec des vitesses de broche élevées, faire en sorte que l'outil et le porte-outil de fraisage soient correctement équilibrés.

Remarque 3) Plaquettes avec un rayon de 1.6mm ou plus : lorsque le rayon de pointe augmente, les dimensions LF et LH diminuent.



* Couple de serrage (N • m) : TS3SBS=1,5, TS3SB=1,5

Lors du changement de plaquette, il est préconisé de changer également les vis de plaquettes.

● : Article stocké. ★ : Article standard Japon.

K156 (10 plaquettes par boîte)

PLAQUETTES

Matière	N	Alliage aluminium	●	✦	✦	Conditions de coupe (Guide):					Géométrie
	S	Alliage titane				●	●	✦	●	●	
						Honing: F: Affûtée E: Ronde					
Forme	Référence	Classe	Honing	Stock			Dimensions (mm)				
				Revêtu	Carbure		L	LE	S	BS	RE*
				LC15TF	MP9120	TF15					
GL Brise-copeaux 	XDGX175004PDFR-GL	G F	★	●			23	16.9	5	1.7	0.4
	XDGX175008PDFR-GL	G F	★	●			23	17	5	1.3	0.8
	XDGX175012PDFR-GL	G F	★	●			23	17	5	0.9	1.2
	XDGX175016PDFR-GL	G F	★	●			22	16.4	5	1.4	1.6
	XDGX175020PDFR-GL	G F	★	●			22	16.4	5	1.0	2.0
	XDGX175024PDFR-GL	G F	★	●			22	16.4	5	0.6	2.4
	XDGX175030PDFR-GL	G F	★	●			21.1	16.1	5	0.8	3.0
	XDGX175032PDFR-GL	G F	★	●			21.1	16.1	5	0.6	3.2
	XDGX175040PDFR-GL	G F	★	●			20	15.6	5	0.8	4.0
	XDGX175050PDFR-GL	G F	★	●			19.4	15.3	5	0.4	5.0
GM Brise-copeaux 	XDGX175004PDER-GM	G E		●			23	17	5	1.7	0.4
	XDGX175008PDER-GM	G E		●			23	17	5	1.2	0.8
	XDGX175012PDER-GM	G E		●			23	17	5	0.9	1.2
	XDGX175016PDER-GM	G E		●			22	15.9	5	1.3	1.6
	XDGX175020PDER-GM	G E		●			22	15.9	5	0.8	2.0
	XDGX175024PDER-GM	G E		●			22	15.9	5	0.4	2.4
	XDGX175030PDER-GM	G E		●			21.1	16	5	0.6	3.0
	XDGX175032PDER-GM	G E		●			21.1	16	5	0.4	3.2
	XDGX175040PDER-GM	G E		●			20	14.8	5	0.5	4.0
	XDGX175050PDER-GM	G E		●			19.4	15	5	0.3	5.0
GM Brise-copeaux 	XDGX175004PDFR-GM	G F		●			23	17	5	1.7	0.4
	XDGX175008PDFR-GM	G F		●			23	17	5	1.2	0.8
	XDGX175012PDFR-GM	G F		●			23	17	5	0.9	1.2
	XDGX175016PDFR-GM	G F		●			22	15.9	5	1.3	1.6
	XDGX175020PDFR-GM	G F		●			22	15.9	5	0.8	2.0
	XDGX175024PDFR-GM	G F		●			22	15.9	5	0.4	2.4
	XDGX175030PDFR-GM	G F		●			21.1	16	5	0.6	3.0
	XDGX175032PDFR-GM	G F		●			21.1	16	5	0.4	3.2
	XDGX175040PDFR-GM	G F		●			20	14.8	5	0.5	4.0
	XDGX175050PDFR-GM	G F		●			19.4	15	5	0.3	5.0

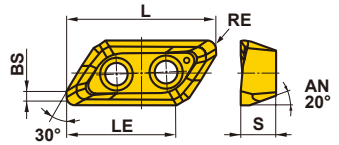

* Veuillez noter que le rayon R réalisé sur la pièce sera différent du rayon de plaquette RE.
Le rayon sera plus précis avec le brise-copeaux GM.

COMBINAISON CORPS DE FRAISE / RAYON DE PLAQUETTE

Porte-outil	Porte-outil type A								Porte-outil type B	
	AXD4000-○○○○○○○○○○ A AXD4000R○○○○○○○○○○ A								AXD4000-○○○○○○○○○○ B AXD4000R○○○○○○○○○○ B	
Rayon de plaquette applicable R (RE)	R0.4	R0.8	R1.2	R1.6	R2.0	R2.4	R3.0	R3.2	R4.0	R5.0
	XDGX 175004PD R	XDGX 175008PD R	XDGX 175012PD R	XDGX 175016PD R	XDGX 175020PD R	XDGX 175024PD R	XDGX 175030PD R	XDGX 175032PD R	XDGX 175040PD R	XDGX 175050PD R

Veuillez noter que la plaquette pour la fraise de type A et la plaquette pour la fraise de type B ne sont pas compatibles.

AXD4000 - Sélection de plaquette

Il est essentiel de sélectionner la plaquette correspondant le mieux aux conditions d'utilisation. Veuillez sélectionner une plaquette dans le tableau ci-dessous.

La 1ère recommandation pour des conditions de coupe stables est le brise-copeaux GL avec une arête de coupe vive.

Sélection de plaquette selon l'avance par dent et la profondeur passe

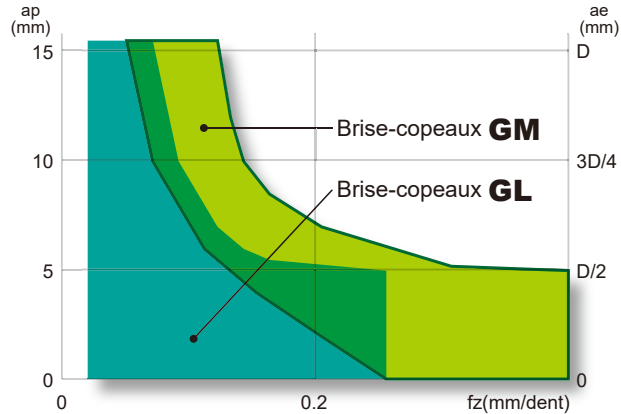

Sélection de plaquette selon l'engagement et la profondeur de passe

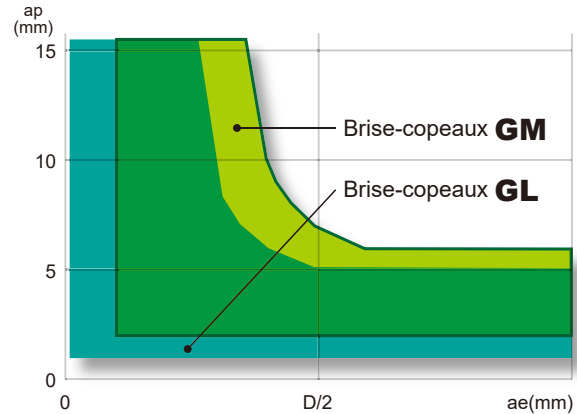

La 1ère recommandation pour l'usinage des alliages d'aluminium est le brise-copeaux GL.

En cas de grand débit, de grande profondeur de passe ou de forte avance, le brise-copeaux GM est recommandé.

Sélection de plaquette selon l'arête de coupe

Type plaquette

Arête de coupe vive

Arête de coupe vive

Revêtement PVD et préparation en rayon

GL
TF15/LC15TF

Faible effort de coupe

GM
TF15

Arête de coupe renforcée

GM
MP9120

Arête de coupe plus robuste et résistante à l'usure.
Usinage de titane et d'aluminium

Sélection de plaquette selon la résistance à l'usure

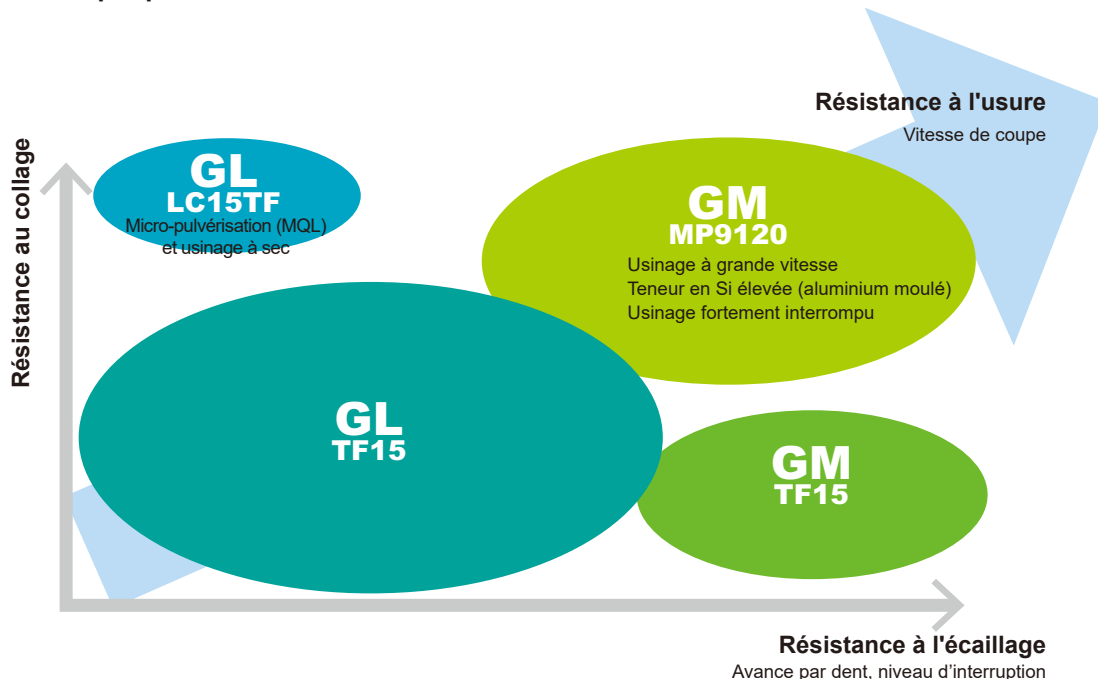

CONDITIONS DE COUPE RECOMMANDÉES

■ Vitesse de coupe

Matière		Nuance	Brise-copeaux	Vitesse de coupe Vc (m/min)	
N	Alliage aluminium (A6061, A7075 etc)	TF15 LC15TF	GL	1000 (200–3000)	
		TF15 MP9120	GM	1000 (200–3000)	
	Alliage aluminium (AC4B, ADC12, A390 etc)	5% ≤ Si ≤ 10% Si > 10%	MP9120	GM	1000 (200–3000)
S	Alliage titane (Ti-6Al-4V etc)	–	MP9120	GM	40 (30–60)

■ Profondeur de Passe / Avance par Dent

Matière	Brise-copeaux	Largeur de coupe ae (mm)	Profondeur de Passe ap (mm)	Avance par dent (mm/dent)										
				Diamètre de l'arête de coupe DC (mm)										
				20	25, 28	32, 35	40	50, 63, 80	100, 125					
Alliage aluminium (A6061, A7075 etc)	Si < 5%	GL	≤ 0.25 DC	≤ 5	≤ 0.05	≤ 0.25	≤ 0.25	≤ 0.25	≤ 0.25	≤ 0.25	≤ 0.25			
				≤ 10	≤ 0.05	≤ 0.2	≤ 0.2	≤ 0.2	≤ 0.2	≤ 0.2	≤ 0.2			
				≤ 14.5	≤ 0.05	≤ 0.15	≤ 0.15	≤ 0.15	≤ 0.15	≤ 0.15	≤ 0.15			
			≤ 0.5 DC	≤ 5	≤ 0.05	≤ 0.25	≤ 0.25	≤ 0.25	≤ 0.25	≤ 0.25	≤ 0.25			
				≤ 10	–	≤ 0.2	≤ 0.2	≤ 0.2	≤ 0.2	≤ 0.2	≤ 0.2			
				≤ 14.5	–	≤ 0.15	≤ 0.15	≤ 0.15	≤ 0.15	≤ 0.15	≤ 0.15			
			≤ 0.75 DC	≤ 5	≤ 0.05	≤ 0.25	≤ 0.25	≤ 0.25	≤ 0.25	≤ 0.25	≤ 0.25			
				≤ 10	–	≤ 0.2	≤ 0.2	≤ 0.2	≤ 0.2	≤ 0.2	≤ 0.2			
				≤ 14.5	–	≤ 0.15	≤ 0.15	≤ 0.15	≤ 0.15	≤ 0.15	≤ 0.15			
			DC (rainure)	≤ 5	≤ 0.05	≤ 0.25	≤ 0.25	≤ 0.25	≤ 0.25	≤ 0.25	≤ 0.25			
			Alliage aluminium (A6061, A7075 etc)	Si < 5%	GM	≤ 0.25 DC	≤ 5	≤ 0.05	≤ 0.35	≤ 0.35	≤ 0.4	≤ 0.4	≤ 0.4	
							≤ 10	≤ 0.05	≤ 0.3	≤ 0.3	≤ 0.35	≤ 0.35	≤ 0.35	≤ 0.35
≤ 14.5	≤ 0.05	≤ 0.25					≤ 0.25	≤ 0.3	≤ 0.3	≤ 0.3	≤ 0.3			
≤ 0.5 DC	≤ 5	≤ 0.05				≤ 0.35	≤ 0.35	≤ 0.35	≤ 0.4	≤ 0.4	≤ 0.4			
	≤ 10	–				≤ 0.3	≤ 0.3	≤ 0.3	≤ 0.35	≤ 0.35	≤ 0.35			
	≤ 14.5	–				≤ 0.2	≤ 0.25	≤ 0.25	≤ 0.3	≤ 0.3	≤ 0.3			
≤ 0.75 DC	≤ 5	≤ 0.05				≤ 0.3	≤ 0.3	≤ 0.3	≤ 0.35	≤ 0.35	≤ 0.35			
	≤ 10	–				≤ 0.25	≤ 0.25	≤ 0.25	≤ 0.3	≤ 0.3	≤ 0.3			
	≤ 14.5	–				≤ 0.2	≤ 0.2	≤ 0.2	≤ 0.25	≤ 0.25	≤ 0.25			
DC (rainure)	≤ 5	≤ 0.05				≤ 0.25	≤ 0.25	≤ 0.3	≤ 0.35	≤ 0.35	≤ 0.35			
Alliage aluminium (AC4B etc) Alliage aluminium (ADC12, A390 etc)	5% ≤ Si ≤ 10% Si > 10%	GM				≤ 0.25 DC	≤ 5	≤ 0.05	≤ 0.35	≤ 0.35	≤ 0.4	≤ 0.4	≤ 0.4	
							≤ 10	≤ 0.05	≤ 0.3	≤ 0.3	≤ 0.35	≤ 0.35	≤ 0.35	≤ 0.35
			≤ 14.5	≤ 0.05	≤ 0.25		≤ 0.25	≤ 0.3	≤ 0.3	≤ 0.3	≤ 0.3			
			≤ 0.5 DC	≤ 5	≤ 0.05	≤ 0.35	≤ 0.35	≤ 0.35	≤ 0.4	≤ 0.4	≤ 0.4			
				≤ 10	–	≤ 0.3	≤ 0.3	≤ 0.3	≤ 0.35	≤ 0.35	≤ 0.35			
				≤ 14.5	–	≤ 0.2	≤ 0.25	≤ 0.25	≤ 0.3	≤ 0.3	≤ 0.3			
			≤ 0.75 DC	≤ 5	≤ 0.05	≤ 0.3	≤ 0.3	≤ 0.3	≤ 0.35	≤ 0.35	≤ 0.35			
				≤ 10	–	≤ 0.25	≤ 0.25	≤ 0.25	≤ 0.3	≤ 0.3	≤ 0.3			
				≤ 14.5	–	≤ 0.2	≤ 0.2	≤ 0.2	≤ 0.25	≤ 0.25	≤ 0.25			
			DC (rainure)	≤ 5	≤ 0.05	≤ 0.25	≤ 0.25	≤ 0.3	≤ 0.35	≤ 0.35	≤ 0.35			
			Alliage titane (Ti-6Al-4V etc)	–	GM	≤ 0.25 DC	≤ 5	≤ 0.05	≤ 0.1	≤ 0.1	≤ 0.1	≤ 0.1	≤ 0.1	≤ 0.1
							≤ 10	≤ 0.05	≤ 0.1	≤ 0.1	≤ 0.1	≤ 0.1	≤ 0.1	≤ 0.1
≤ 14.5	≤ 0.05	≤ 0.1					≤ 0.1	≤ 0.1	≤ 0.1	≤ 0.1	≤ 0.1			
≤ 0.5 DC	≤ 5	≤ 0.05				≤ 0.08	≤ 0.1	≤ 0.1	≤ 0.1	≤ 0.1	≤ 0.1			
	≤ 10	–				≤ 0.08	≤ 0.1	≤ 0.1	≤ 0.1	≤ 0.1	≤ 0.1			
	≤ 14.5	–				≤ 0.08	≤ 0.1	≤ 0.1	≤ 0.1	≤ 0.1	≤ 0.1			
≤ 0.75 DC	≤ 5	≤ 0.05				≤ 0.05	≤ 0.08	≤ 0.1	≤ 0.1	≤ 0.1	≤ 0.1			
	≤ 10	–				≤ 0.05	≤ 0.08	≤ 0.1	≤ 0.1	≤ 0.1	≤ 0.1			
	≤ 14.5	–				≤ 0.05	≤ 0.08	≤ 0.1	≤ 0.1	≤ 0.1	≤ 0.1			
DC (rainure)	≤ 5	≤ 0.05				≤ 0.05	≤ 0.05	≤ 0.05	≤ 0.05	≤ 0.05	≤ 0.05			

Remarque 1) Les conditions de coupe ci-dessus sont déterminées pour une machine et une pièce de haute rigidité, sans vibrations. En cas de vibrations, veuillez ajuster les conditions d'usinage.

Remarque 2) Des vibrations peuvent survenir dans les conditions suivantes :

Lors d'un porte-à-faux important. Lors d'usinage de poche, rayon de pointe.

Lorsque la pièce a une mauvaise fixation ou que la machine a une faible rigidité, des vibrations peuvent apparaître facilement. Si c'est le cas, de réduire les conditions de coupe tels que la largeur et la profondeur de coupe et avance par dent.

K

FRAISES À PLAQUETTES

FRAISES À PLAQUETTES

■ RAMPING/INTERPOLATION HÉLICOÏDALE

● RAMPING

● INTERPOLATION HÉLICOÏDALE

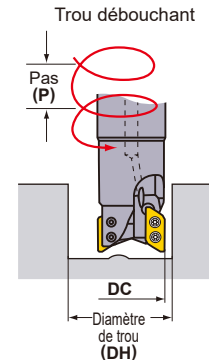
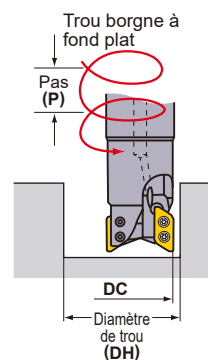
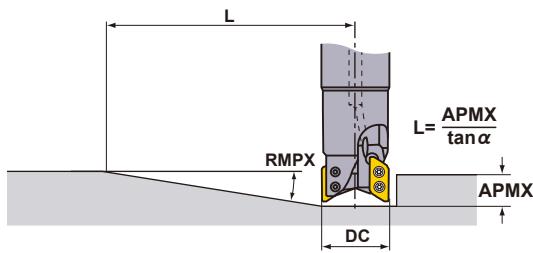

RAMPING/INTERPOLATION HÉLICOÏDALE (Alliage aluminium)

Porte-outil	Diamètre de l'arête de coupe DC (mm)	Rayon plaquette RE (mm)	Ramping		Interpolation hélicoïdale (Trous borgne à fond plat)				Interpolation hélicoïdale	
			Angle max. de ramping RMPX	Distance*1 minimum L (mm)	Diamètre de trou maximum DH max. (mm)	Pas maximum P max. (mm)	Diamètre de trou minimum DH min. (mm)	Pas maximum P max. (mm)	Diamètre de trou minimum DH min. (mm)	Pas maximum P max. (mm)
Type A	20	0.4-1.2	20.7°	42	37.1 *2	14	36.1	14	22	2
		1.6-2.4	19.9°	43	34.7 *3	13	34.6	13	22	2
		3.0-3.2	18.9°	46	33.1 *4	12	33.3	12	22	1
	25	0.4-1.2	23.1°	37	47.1 *2	14	46	14	31.6	8
		1.6-2.4	22.0°	39	44.7 *3	13	44.4	13	31.6	8
		3.0-3.2	18.7°	46	43.1 *4	12	43	12	31.6	7
	28	0.4-1.2	19.2°	45	53.1 *2	14	52	14	36	8
		1.6-2.4	18.5°	47	50.7 *3	13	50.4	13	36	8
		3.0-3.2	16.7°	52	49.1 *4	12	48.9	12	36	7
	32	0.4-1.2	15.4°	57	61.1 *2	14	59.9	14	45.5	11
		1.6-2.4	14.7°	60	58.7 *3	13	58.3	13	45.5	11
		3.0-3.2	13.8°	64	57.1 *4	12	56.8	12	45.5	10
	35	0.4-1.2	13.4°	66	67.1 *2	14	65.8	14	50	11
		1.6-2.4	12.7°	69	64.7 *3	13	64.3	13	50	10
		3.0-3.2	11.8°	75	63.1 *4	12	62.8	12	50	9
	40	0.4-1.2	11.1°	80	76.7 *2	14	75.9	14	61.5	13
		1.6-2.4	10.4°	85	74.3 *3	13	74.2	13	61.5	12
		3.0-3.2	9.7°	91	72.7 *4	12	72.7	12	61.5	11
	50	0.4-1.2	8.2°	108	96.7 *2	14	95.6	14	81.4	14
		1.6-2.4	7.6°	117	94.3 *3	13	94	13	81.4	13
		3.0-3.2	6.9°	129	92.7 *4	12	92.4	12	81.4	11
	63	0.4-1.2	6.1°	146	122.7 *2	14	121.6	14	107.4	14
		1.6-2.4	5.6°	159	120.3 *3	13	119.9	13	107.4	13
		3.0-3.2	5.2°	171	118.7 *4	12	118.4	12	107.4	12
80	0.4-1.2	4.6°	193	156.7 *2	14	155.6	14	141.4	14	
	1.6-2.4	4.2°	212	154.3 *3	13	153.9	13	141.4	13	
	3.0-3.2	3.8°	234	152.7 *4	12	152.4	12	141.4	12	
100	0.4-1.2	3.5°	254	196.7 *2	14	195.5	14	181.5	14	
	1.6-2.4	3.2°	278	194.3 *3	13	193.9	13	181.5	13	
	3.0-3.2	2.9°	306	192.7 *4	12	192.3	12	181.5	12	
125	0.4-1.2	2.7°	329	246.7 *2	14	245.5	14	231.5	14	
	1.6-2.4	2.5°	356	244.3 *3	13	243.8	13	231.5	13	
	3.0-3.2	2.3°	386	242.7 *4	12	242.3	12	231.5	12	

Remarque 1) Le ramping, la coupe hélicoïdale et le perçage ne sont pas recommandés lors de l'usinage d'aciers et de titane.

*1 Utiliser l'angle maximum de ramping, la distance pour obtenir une profondeur de coupe maximum, est comme suit :

$L = (\text{profondeur de coupe max.} / \tan \alpha)$. Profondeur de coupe maximum de type A est 15.5mm, type B est 14.8mm.

*2 Rayon de 1.2mm. Pour les autres rayons, utiliser la formule suivante : $\{(\text{diamètre de coupe DC}) - (\text{Rayon de pointe RE}) - 0.25\} \times 2$

*3 Rayon de 2.4mm. Pour les autres rayons, utiliser la formule suivante : $\{(\text{diamètre de coupe DC}) - (\text{Rayon de pointe RE}) - 0.25\} \times 2$

*4 Rayon de 3.2mm. Pour les autres rayons, utiliser la formule suivante : $\{(\text{diamètre de coupe DC}) - (\text{Rayon de pointe RE}) - 0.25\} \times 2$

Porte-outil	Diamètre de l'arête de coupe DC (mm)	Rayon plaquette RE (mm)	Ramping		Interpolation hélicoïdale (Trou borgne à fond plat)				Interpolation hélicoïdale	
			Angle max. de ramping RMPX	Distance*1 minimum L (mm)	Diamètre de trou maximum DH max. (mm)	Pas maximum P max. (mm)	Diamètre de trou minimum DH min. (mm)	Pas maximum P max. (mm)	Diamètre de trou minimum DH min. (mm)	Pas maximum P max. (mm)
Type B	20	4	17.5°	47	31.5	10	31.8	10	22	1
		5	16.6°	71	29.5	6	31.1	7	22	1
	25	4	15.1°	55	41.5	10	41.4	10	31.7	5
		5	13.7°	61	39.5	9	40.6	9	31.7	5
	28	4	14.1°	59	47.5	10	47.2	10	36	6
		5	13°	65	45.5	9	46.4	9	36	5
	32	4	12.7°	66	55.5	10	55.1	10	45.5	9
		5	12°	70	53.5	9	54.3	9	45.5	8
	35	4	10.8°	78	61.5	10	61	10	50	8
		5	10.2°	83	59.5	9	60.2	9	50	8
	40	4	8.8°	96	71.1	10	70.9	10	61.5	10
		5	8.2°	103	69.1	9	70.1	9	61.5	9
	50	4	6.3°	135	91.1	10	90.6	10	81.3	10
		5	5.8°	146	89.1	9	89.8	9	81.3	9
	63	4	4.6°	184	117.1	10	116.6	10	107.4	10
		5	4.2°	202	115.1	9	115.7	9	107.3	9
	80	4	3.4°	250	151.1	10	150.5	10	141.4	10
		5	3.1°	274	149.1	9	149.6	9	141.4	9
	100	4	2.6°	326	191.1	10	190.5	10	181.4	10
		5	2.4°	354	189.1	9	189.6	9	181.4	9
125	4	2°	424	241.1	10	240.5	10	231.4	10	
	5	1.8°	471	239.1	9	239.6	9	229.9	9	

Remarque 1) L'avance recommandée de ramping est de 0.05mm/dent ou moins.

*1 Utiliser l'angle maximum de ramping, la distance pour obtenir une profondeur de coupe maximum, est comme suit :

$L = (\text{profondeur de coupe max.} / \tan \alpha)$. Profondeur de coupe maximum de type A est 15.5mm, type B est 14.8mm.

*2 Rayon de 1.2mm. Pour les autres rayons, utiliser la formule suivante : $\{(\text{diamètre de coupe DC}) - (\text{Rayon de pointe RE}) - 0.25\} \times 2$

*3 Rayon de 2.4mm. Pour les autres rayons, utiliser la formule suivante : $\{(\text{diamètre de coupe DC}) - (\text{Rayon de pointe RE}) - 0.25\} \times 2$

*4 Rayon de 3.2mm. Pour les autres rayons, utiliser la formule suivante : $\{(\text{diamètre de coupe DC}) - (\text{Rayon de pointe RE}) - 0.25\} \times 2$

■ Prof. de Perçage Max. (Alliage aluminium)

Type	Rayon plaquette RE (mm)	Prof. de Perçage Max. (mm)					
		Diamètre de l'arête de coupe DC (mm)					
		φ20	φ25	φ28	φ32	φ35	φ40-φ125
Type A	0.4	5.3	5.2	5.2	5.2	5.3	5.3
	0.8	5.3	5.2	5.2	5.2	5.3	5.3
	1.2	5.3	5.2	5.2	5.2	5.3	5.3
	1.6	4.8	4.6	4.7	4.7	4.9	4.8
	2.0	4.8	4.6	4.7	4.7	4.9	4.8
	2.4	4.8	4.6	4.7	4.7	4.9	4.8
	3.0	4.3	3.7	4.2	4.2	4.4	4.4
	3.2	4.3	3.7	4.2	4.2	4.4	4.4
Type B	4.0	3.7	2.7	3.7	3.6	3.8	3.8
	5.0	3.4	2.3	3.3	3.3	3.5	3.5

AXD4000 peut être utilisée pour le perçage et l'ouverture de poche avec le même outil

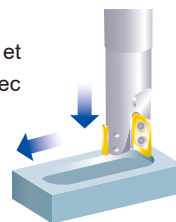

FRAISES À PLAQUETTES

**FRAISES
MULTI FONCTIONS**
<POUR LES ALLIAGES D'ALUMINIUM>

90°
KAPR



AXD4000A NEW

P M K **N** S H



K

FRAISES À PLAQUETTES

ø50

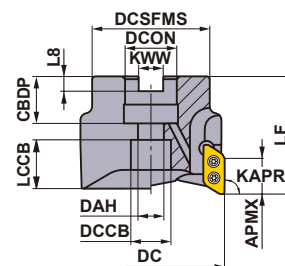

Fraise à droite uniquement.

Diamètre fraise DC (mm)	Vis d'attachement	Géométrie
ø50	HSC10030H	

■ ATTACHEMENT PAR ALÉSAGE

KAPR : 90°
GAMP : +10° GAMPF : +21°
Avec trou de lubrification

DC	Type	Rayon plaquette RE	Référence	Stock R	Nombre de dents	Dimensions (mm)		WT (kg)	APMX (mm)	RPMX (min ⁻¹)	 Type Plaquette
						LF	DCON				
50	D	0.4–3.2	AXD4000A-050A04RD	●	4	50	22	0.4	15.5	34000	XDGX1750
50	E	4.0–5.0	AXD4000A-050A04RE	●	4	50	22	0.4	14.8	34000	XDGX1750

Remarque 1) La vitesse de rotation maximum est indiquée pour garantir la stabilité de l'outil et de la plaquette.

Veuillez tenir compte du régime maximal RPMX (tr/min).

Remarque 2) L'équilibrage de l'outil doit être de qualité G6.3 (ISO1940) ou ISO16084, lorsque la vitesse de broche est supérieure à 6000 tr/min⁻¹.

Remarque 3) Lorsque vous utilisez l'outil avec des vitesses de broche élevées, faire en sorte que l'outil et le porte-outil de fraisage soient correctement équilibrés.

Remarque 4) Plaquettes avec un rayon de 1.6mm ou plus : lorsque le rayon de pointe augmente, les dimensions LF diminuent.

DIMENSIONS DE MONTAGE

DC	Référence	Dimensions (mm)							
		DCON	CBDB	DAH	DCCB	LCCB	DCSFMS	KWW	L8
50	AXD4000A-050A04RD	22	20	11	17	15.4	45	10.4	6.3
50	AXD4000A-050A04RE	22	20	11	17	14.6	45	10.4	6.3

PIÈCES DÉTACHÉES



	*		
Vis de fixation		Clé	Anti-grippant
TPS3SB		TIP10D	MK1KS

* Couple de serrage (N • m) : TPS3SB = 3.0

Remarque 1) La vis de serrage et la clé de AXD4000A sont différentes de l'AXD4000.

● : Article stocké. ★ : Article standard Japon.
(10 plaquettes par boîte)

PLAQUETTES

Matière	N	Alliage aluminium		●	✱	●	✱	Conditions de coupe (Guide) : ● : Coupe Stable ● : Coupe Générale ✱ : Coupe Instable Honing : F : Affûtée E : Ronde							
	Forme	Référence	Classe	Honing	Stock				Dimensions (mm)					Géométrie	
Revêtu					Non-revêtu		L	LE	S	BS	RE*				
					LC15TF	MP9120		NEW MT2010	TF15						
Arête de coupe renforcée GM Brise-copeaux 	XDGX175004PDFR-GM	G	F					●	●	23.0	17.0	5	1.7	0.4	
	XDGX175008PDFR-GM	G	F					●	●	23.0	17.0	5	1.2	0.8	
	XDGX175012PDFR-GM	G	F					★	●	23.0	17.0	5	0.9	1.2	
	XDGX175016PDFR-GM	G	F					●	●	22.0	15.9	5	1.3	1.6	
	XDGX175020PDFR-GM	G	F					●	●	22.0	15.9	5	0.8	2.0	
	XDGX175024PDFR-GM	G	F					★	●	22.0	15.9	5	0.4	2.4	
	XDGX175030PDFR-GM	G	F					●	●	21.1	16.0	5	0.6	3.0	
	XDGX175032PDFR-GM	G	F					●	●	21.1	16.0	5	0.4	3.2	
	XDGX175040PDFR-GM	G	F					●	●	20.0	14.8	5	0.5	4.0	
	XDGX175050PDFR-GM	G	F					★	●	19.4	15.0	5	0.3	5.0	
Arête de coupe renforcée résistante à l'écaillage GM Brise-copeaux 	XDGX175004PDER-GM	G	E							23.0	17.0	5	1.7	0.4	
	XDGX175008PDER-GM	G	E							23.0	17.0	5	1.2	0.8	
	XDGX175012PDER-GM	G	E							23.0	17.0	5	0.9	1.2	
	XDGX175016PDER-GM	G	E							22.0	15.9	5	1.3	1.6	
	XDGX175020PDER-GM	G	E							22.0	15.9	5	0.8	2.0	
	XDGX175024PDER-GM	G	E							22.0	15.9	5	0.4	2.4	
	XDGX175030PDER-GM	G	E							21.1	16.0	5	0.6	3.0	
	XDGX175032PDER-GM	G	E							21.1	16.0	5	0.4	3.2	
XDGX175040PDER-GM	G	E							20.0	14.8	5	0.5	4.0		
XDGX175050PDER-GM	G	E							19.4	15.0	5	0.3	5.0		
Faible effort de coupe GL Brise-copeaux 	XDGX175004PDFR-GL	G	F	★					●	23.0	16.9	5	1.7	0.4	
	XDGX175008PDFR-GL	G	F	★					●	23.0	17.0	5	1.3	0.8	
	XDGX175012PDFR-GL	G	F	★					●	23.0	17.0	5	0.9	1.2	
	XDGX175016PDFR-GL	G	F	★					●	22.0	16.4	5	1.4	1.6	
	XDGX175020PDFR-GL	G	F	★					●	22.0	16.4	5	1.0	2.0	
	XDGX175024PDFR-GL	G	F	★					●	22.0	16.4	5	0.6	2.4	
	XDGX175030PDFR-GL	G	F	★					●	21.1	16.1	5	0.8	3.0	
	XDGX175032PDFR-GL	G	F	★					●	21.1	16.1	5	0.6	3.2	
	XDGX175040PDFR-GL	G	F	★					●	20.0	15.6	5	0.8	4.0	
XDGX175050PDFR-GL	G	F	★					●	19.4	15.3	5	0.4	5.0		

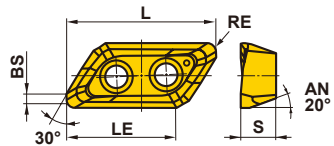











* Veuillez noter que le rayon R réalisé sur la pièce sera différent du rayon de plaquette RE.
Le rayon sera plus précis avec le brise-copeaux GM.

● = NEW

K
FRAISES À PLAQUETTES

COMBINAISON CORPS DE FRAISE / RAYON DE PLAQUETTE

Porte-outil	Porte-outil type D								Porte-outil type E	
	AXD4000A-050A04RD								AXD4000A-050A04RE	
Rayon de plaquette applicable R (RE)	R0.4	R0.8	R1.2	R1.6	R2.0	R2.4	R3.0	R3.2	R4.0	R5.0
										
	XDGX 175004PD R	XDGX 175008PD R	XDGX 175012PD R	XDGX 175016PD R	XDGX 175020PD R	XDGX 175024PD R	XDGX 175030PD R	XDGX 175032PD R	XDGX 175040PD R	XDGX 175050PD R

Remarque 1) D'autres combinaisons de porte-outil et plaquettes ne sont pas possibles.

AXD4000A - Sélection de plaquette

Il est essentiel de sélectionner la plaquette correspondant le mieux aux conditions d'utilisation. Veuillez sélectionner une plaquette dans le tableau ci-dessous.

La 1ère recommandation pour un usinage à grand débit de copeaux et une vitesse de rotation élevée est le brise-copeaux GM à arête de coupe renforcée.

Sélection de plaquette selon l'avance par dent et la profondeur de passe

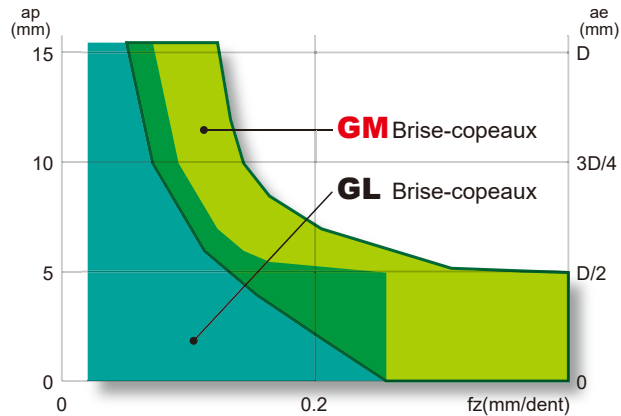

Sélection de plaquette selon l'engagement et la profondeur de passe

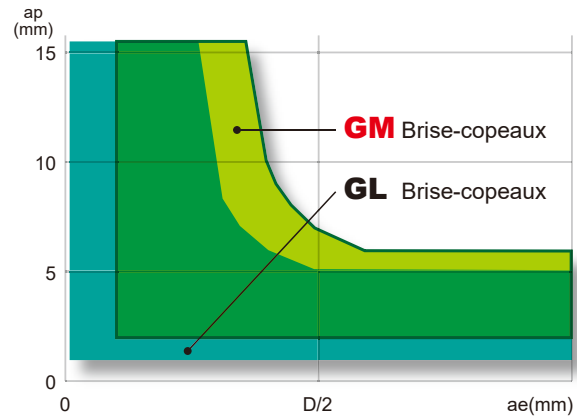

La 1ère recommandation pour l'usinage des alliages d'aluminium est le brise-copeaux GL.

En cas de grand débit, de grande profondeur de passe ou de forte avance, le brise-copeaux GM est recommandé.

Sélection de plaquette selon l'arrête de coupe

Type plaquette

Arête de coupe vive

Arête de coupe vive

Revêtement PVD et préparation en rayon

GL
TF15/LC15TF

Faible prise de puissance
LC15TF : Excellente résistance au collage.

GM
MT2010/TF15

Arête de coupe renforcée

GM
MP9120

Arête de coupe plus robuste et résistante à l'usure.

Sélection de plaquette selon la résistance à l'usure

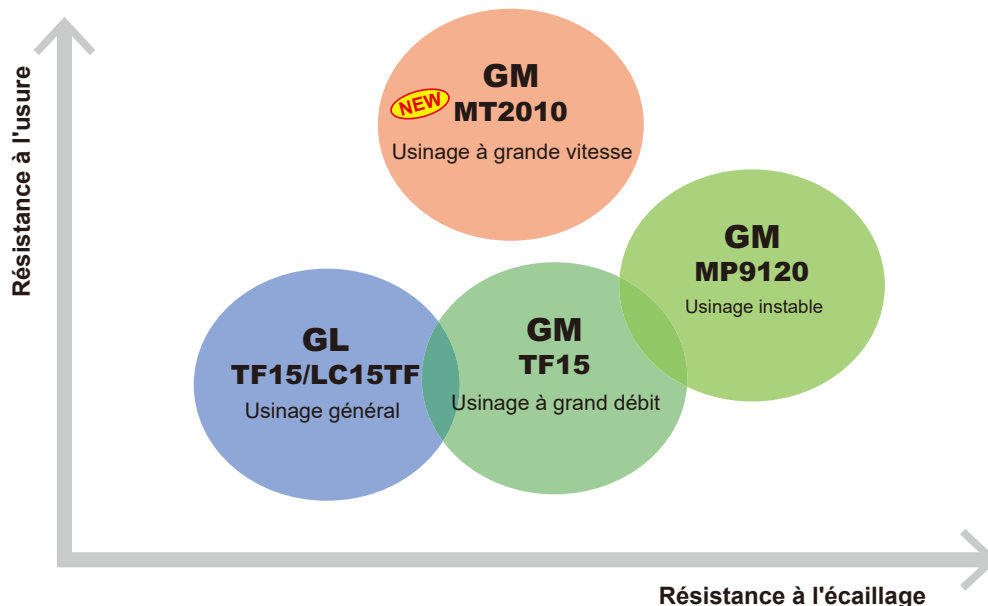

K

FRAISES À PLAQUETTES

CONDITIONS DE COUPE RECOMMANDÉES

Matière	Propriétés	Nuance	Brise-copeaux	Vitesse de coupe Vc (m/min)	Largeur de coupe ae (mm)	Profondeur de Passe ap (mm)	Avance par dent (mm/dent)
N Alliage aluminium (A7050, A7075, A2024, A6061 etc) Alliage aluminium-lithium	Content Si < 5%	MT2010 TF15 MP9120	GM	4000(2000–5000)	≤ 0.5 DC	≤ 5	≤ 0.35
						≤ 10	≤ 0.30
						≤ 14.5	≤ 0.25
		TF15 LC15TF	GL	4000(2000–5000)	≤ 0.75 DC	≤ 5	≤ 0.30
						≤ 10	≤ 0.25
						≤ 14.5	≤ 0.20
DC (rainurage)	≤ 5	≤ 0.30					
DC (rainurage)	≤ 5	≤ 0.20					
DC (rainurage)	≤ 5	≤ 0.15					
DC (rainurage)	≤ 5	≤ 0.10					
DC (rainurage)	≤ 5	≤ 0.20					

Remarque 1) Les conditions de coupe ci-dessus sont déterminées pour une machine et une pièce de haute rigidité, sans vibrations. En cas de vibrations, veuillez ajuster les conditions d'usinage.

Remarque 2) Des vibrations peuvent survenir dans les conditions suivantes :

- Lors d'un porte-à-faux important.
- Lors d'usinage de poche, rayon de pointe.
- Lorsque la pièce a une mauvaise fixation ou que la machine a une faible rigidité, des vibrations peuvent apparaître facilement, Si c'est le cas, de réduire les conditions de coupe tels que la largeur et la profondeur de coupe et avance par dent.

■ RAMPING / FRAISAGE HÉLICOÏDAL / PERÇAGE

● RAMPING

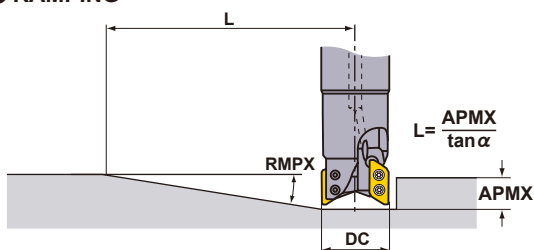

● INTERPOLATION HÉLICOÏDALE

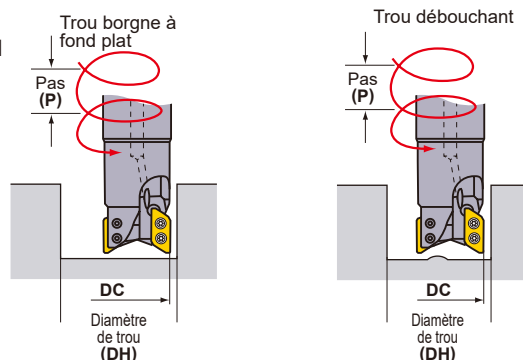

Se référer au tableau ci-dessous pour les conditions de coupe.

Pour l'avance par dent et la vitesse de coupe, se référer aux conditions de coupe pour rainurage.

DC (mm)	Type	Rayon plaquette RE (mm)	Ramping		Interpolation hélicoïdale (Trou borgne à fond plat)			Interpolation hélicoïdale (Trou débouchant)		Perçage
			RMPX	L *1 (mm)	DH max. (mm)	DH min. (mm)	P max. (mm)	DH min. (mm)	P max. (mm)	
50	D	0.4–1.2	8.2°	108	96.8 *2	95.4	14	81.2	14	5.5
		1.6–2.4	7.6°	117	94.4 *3	93.6	13	81.2	13	5.0
		3.0–3.2	6.9°	129	92.8 *4	92.0	12	81.2	12	4.5
	E	4.0	6.3°	135	91.2	90.0	10	81.2	10	3.9
		5.0	5.8°	146	89.2	88.8	9	81.2	9	3.6

*1 Utiliser l'angle maximum de ramping, la distance pour obtenir une profondeur de coupe maximum, est comme suit :

$L = (\text{profondeur de coupe max. APMX} / \tan \alpha)$. Profondeur de coupe maximum de type D est 15.5mm, type E est 14.8mm.

*2 Rayon de 1.2mm. Pour les autres rayons, utiliser la formule suivante : $\{(\text{diamètre de coupe DC}) - (\text{Rayon de pointe RE}) - 0.3\} \times 2$

*3 Rayon de 2.4mm. Pour les autres rayons, utiliser la formule suivante : $\{(\text{diamètre de coupe DC}) - (\text{Rayon de pointe RE}) - 0.3\} \times 2$

*4 Rayon de 3.2mm. Pour les autres rayons, utiliser la formule suivante : $\{(\text{diamètre de coupe DC}) - (\text{Rayon de pointe RE}) - 0.3\} \times 2$

Remarque 1) L'avance recommandée de ramping est de 0.05mm/dent ou moins.

FRAISES À PLAQUETTES

FRAISES MULTI FONCTIONS <POUR L'ALUMINIUM>



AXD7000

P M K **N** S H



K

FRAISES À PLAQUETTES

Fig.1

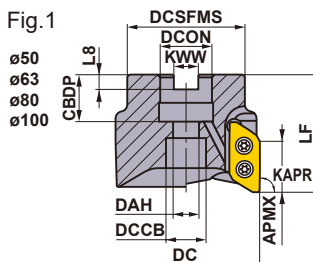
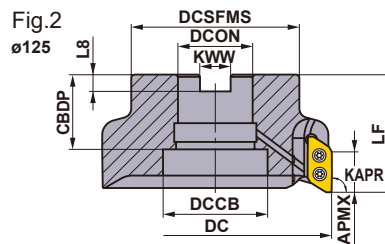

Fig.2



Fraise à droite uniquement.

ATTACHEMENT PAR ALÉSAGE

KAPR : 90°
GAMP: +11° GAMF: +26° - +29°

Diamètre fraise DC (mm)	Vis d'attachement	Géométrie
φ50, φ63	HSC10030H	
φ80	HSC12035H	
φ100	HSC16040H	
φ125	MBA20040H	

Type	Rayon plaquette RE	Référence	Stock R	Nombre de dents	Dimensions (mm)								*2 WT (kg)	APMX (mm)	Vitesse de rotation maxi. recommandée (min ⁻¹)	Fig.					
					DC	LF	DCON	CBDP	DAH	DCSFMS	KWW	L8									DCCB
Type A	0.8	AXD7000-050A03RA	●	3	50	50	22	20	11	45	10.4	6.3	17	0.4	21	30000	1	TS4SBL	TKY15D	MK1KS	XDGX2270
	3.2	AXD7000-063A03RA	●	3	63	50	22	20	11	50	10.4	6.3	17	0.5	21	25000	1	TS4SBL	TKY15D	MK1KS	
		AXD7000-080A04RA	●	4	80	63	27	23	13	63	12.4	7	20	1.2	21	23000	1	TS4SBL	TKY15D	MK1KS	
		AXD7000-100A05RA	●	5	100	63	32	26	17	70	14.4	8	26	1.8	21	19000	1	TS4SBL	TKY15D	MK1KS	
		AXD7000-125B06RA	●	6	125	63	40	40	-	90	16.4	9	56	2.7	21	16000	2	TS4SBL	TKY15D	MK1KS	
Type B	4.0	AXD7000-050A03RB	●	3	50	50	22	20	11	45	10.4	6.3	17	0.4	20.4	30000	1	TS4SBL	TKY15D	MK1KS	
	5.0	AXD7000-063A03RB	●	3	63	50	22	20	11	50	10.4	6.3	17	0.5	20.4	25000	1	TS4SBL	TKY15D	MK1KS	
		AXD7000-080A04RB	●	4	80	63	27	23	13	63	12.4	7	20	1.2	20.4	23000	1	TS4SBL	TKY15D	MK1KS	
		AXD7000-100A05RB	●	5	100	63	32	26	17	70	14.4	8	26	1.8	20.4	19000	1	TS4SBL	TKY15D	MK1KS	
		AXD7000-125B06RB	●	6	125	63	40	40	-	90	16.4	9	56	2.7	20.4	16000	2	TS4SBL	TKY15D	MK1KS	

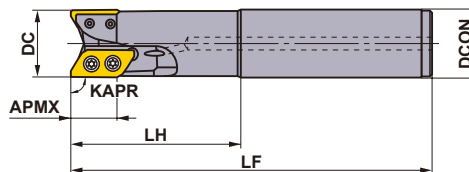

ATTACHEMENT CYLINDRIQUE

KAPR: 90°

Fraise à droite uniquement.

Type	Rayon plaquette RE	Référence	Stock R	Number of Teeth	Dimensions (mm)				APMX (mm)	Vitesse de rotation maxi. recommandée (min ⁻¹)	*1			
					DC	LF	LH	DCON						
Type A	0.8 3.2	AXD7000R322SA32SA	●	2	32	170	80	32	21	41000	TS4SB	TKY15D	MK1KS	XDGX2270
		AXD7000R402SA40SA	●	2	40	170	80	40	21	36000	TS4SBL	TKY15D	MK1KS	
Type B	4.0 5.0	AXD7000R322SA32SB	●	2	32	170	80	32	20.4	41000	TS4SB	TKY15D	MK1KS	
		AXD7000R402SA40SB	●	2	40	170	80	40	20.4	36000	TS4SBL	TKY15D	MK1KS	

Remarque 1) Les vitesses de rotation maximum préconisées assurent fiabilité de l'outil et de la plaquette.

Avant d'utiliser l'outil, veuillez lire les consignes en page K168.

Remarque 2) Lorsque vous utilisez l'outil avec des vitesses de broche élevées, faire en sorte que l'outil et le porte-outil de fraisage soient correctement équilibrés.

Remarque 3) Plaquettes avec un rayon de 3.0mm ou plus : lorsque le rayon de pointe augmente, les dimensions LF et LH diminuent.

*1 Couple de serrage (N · m) : TS4SB=3,5, TS4SBL=3,5

Lors du changement de plaquette, nous recommandons de changer également les vis de plaquettes.

*2 WT : Poids de l'outil

● : Article stocké. ★ : Article standard Japon.

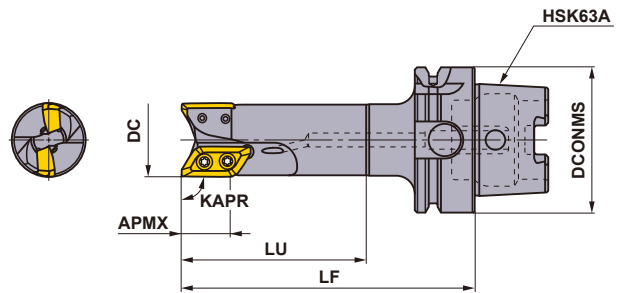

■ HSK63A MONOBLOC

KAPR :90°

Outil à droite uniquement.

Type	Rayon plaquette RE	Référence	Stock R	Nombre de dents	Dimensions (mm)				APMX (mm)	RMPX *2	Vitesse de rotation maxi. recommandée (min ⁻¹)	*1 Vis de serrage	Clé	Anti-grippant	Plaquette
					DC	LF	LU	DCONMS							
Type A	0.8	AXD7000R03202A-H63A	●	2	32	127	80	63	21	19°	41000	TS4SB	TKY15D	MK1KS	XDGX227000 PDFR-GL
	1	AXD7000R04002A-H63A	●	2	40	132	85	63	21	13°	36000	TS4SBL	TKY15D	MK1KS	
	3.2	AXD7000R05003A-H63A	●	3	50	137	90	63	21	9°	30000	TS4SBL	TKY15D	MK1KS	

Remarque 1) Les vitesses de rotation maximum préconisées assurent fiabilité de l'outil et de la plaquette.

Avant d'utiliser l'outil, veuillez lire les consignes en page K168.

Remarque 2) Lorsque vous utilisez l'outil avec des vitesses de broche élevées, faire en sorte que l'outil et le porte-outil de fraisage soient correctement équilibrés.

Remarque 3) Plaquettes avec un rayon de 3.0mm ou plus : lorsque le rayon de pointe augmente, les dimensions LF et LU diminuent.

Remarque 4) Il n'y a pas de trou pour une puce de données

Remarque 5) Les corps en HSK63A sont fournis avec la pipette d'arrosage.

*1 Couple de serrage (N • m) : TS4SB=3,5, TS4SBL=3,5

*2 RMPX : Angle max. de ramping

PLAQUETTES

Matière	N	Alliage aluminium	Conditions de coupe (Guide) :				Honing :			
			● : Coupe Stable	● : Coupe Générale	✦ : Coupe Instable	F : Affûtée				
Forme	Référence	Classe Honing	Stock		Dimensions (mm)					Géométrie
			Revêtu	Non-revêtu	L	LE	S	BS	RE	
	XDGX227008PDFR-GL	G F ★	●		30	21.6	7	2.0	0.8	
	XDGX227016PDFR-GL	G F ★	●		30	21.7	7	1.2	1.6	
	XDGX227020PDFR-GL	G F ★	●		30	21.7	7	0.8	2.0	
	XDGX227030PDFR-GL	G F ★	●		28.8	21.2	7	0.8	3.0	
	XDGX227032PDFR-GL	G F ★	●		28.8	21.2	7	0.6	3.2	
	XDGX227040PDFR-GL	G F ★	●		27.5	20.6	7	0.9	4.0	
	XDGX227050PDFR-GL	G F ★	●		27	20.3	7	0.4	5.0	

■ COMBINAISON CORPS DE FRAISE / RAYON DE PLAQUETTE

Porte-outil	Porte-outil type A					Porte-outil type B	
	AXD7000-○○○○○○○○A AXD7000R○○○○○○○○A AXD7000R○○○○○○○○A-H63A					AXD7000-○○○○○○○○B AXD7000R○○○○○○○○B	
Rayon de plaquette applicable R (RE)							
	XDGX 227008PDFR-GL	XDGX 227016PDFR-GL	XDGX 227020PDFR-GL	XDGX 227030PDFR-GL	XDGX 227032PDFR-GL	XDGX 227040PDFR-GL	XDGX 227050PDFR-GL

Veuillez noter que la plaquette pour la fraise de type A et la plaquette pour la fraise de type B ne sont pas compatibles.

PIÈCES DÉTACHÉES > N001
DONNÉES TECHNIQUES > P001

■ PRÉCAUTION

Procédure de montage des plaquettes

- 1) Nettoyer le logement par soufflage d'air ou avec une brosse avant d'installer la plaquette.
- 2) Serrer la vis de serrage à l'aide de la clé fournie avec le corps tout en appuyant la plaquette contre le logement.
- 3) Serrer la vis de serrage dans l'ordre illustré à la figure 1.
- 4) Enduire la vis de serrage de graisse anti-grippage et la serrer au couple de serrage spécifié.

Le couple de serrage est le suivant :

AXD7000 3,5 Nm (2.58 ft•lb)

AXD4000 1,5 Nm (1.11 ft•lb)

- 5) La vis de serrage est un élément de sécurité important.

Acheter un produit officiel de Mitsubishi Materials.

Lors de l'utilisation de la fraise à des régimes supérieurs à ceux du tableau 2, il est recommandé de remplacer la vis de serrage à chaque remplacement de la plaquette.

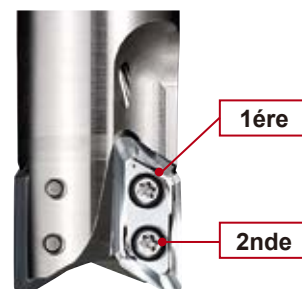

Fig.1

Type	AXD4000		AXD7000	
Diamètre de l'arête de coupe DC(mm)	ø20	ø25-ø125	ø32	ø40-ø125
Vis de serrage	TS3SBS	TS3SB	TS4SB	TS4SBL
Longueur totale L(mm)	6.5	8	9	10.5





- 6) Vérifier qu'il n'y a pas de jeu entre les faces d'appui et la plaquette.

Montage du corps de fraise

- 1) Nettoyer soigneusement l'intérieur et la face d'appui de l'attachement avant d'installer le corps de fraise.
- 2) Monter le corps de fraise sur l'attachement et le serrer. Se référer au tableau ci-dessous pour le couple de serrage.
- 3) Pour l'utilisation de l'arrosage interne, veuillez utiliser les vis d'attachement spécifiques.

AXD4000

Géométrie			Vis d'attachement	Couple de serrage (N • m)	Diamètre de l'arête de coupe DC(mm)	Fig
Fig.1	Fig.2	Fig.3	HFF08043H	11	ø40	1
			HSC10030H	40	ø50, ø63	2
			HSC12035H	80	ø80	2
			HSC16040H	150	ø100	2
			MBA20040H	320	ø120	3

AXD7000



Géométrie		Vis d'attachement	Couple de serrage (N • m)	Diamètre de l'arête de coupe DC(mm)	Fig
Fig.1	Fig.2	HSC10030H	40	ø50, ø63	1
		HSC12035H	80	ø80	1
		HSC16040H	150	ø100	1
		MBA20040H	320	ø120	2

Tableau 1 Vitesse de rotation maxi. recommandée

AXD4000

Diamètre de l'arête de coupe DC(mm)	ø25	ø32	ø40	ø50	ø63	ø80	ø100	ø125
Vitesse de rotation maxi. recommandée (min ⁻¹)	49000	48000	41000	35000	30000	27000	23000	20000

AXD7000

Diamètre de l'arête de coupe DC(mm)	ø32	ø40	ø50	ø63	ø80	ø100	ø125
Vitesse de rotation maxi. recommandée (min ⁻¹)	41000	36000	30000	25000	23000	19000	16000

- Même si la vitesse de rotation est inférieure à la vitesse maximale de broche autorisée, si la vitesse de broche est supérieure ou égale aux valeurs indiquées dans le tableau 2, Pour les fraises à alésage ou à queue cylindrique, il est recommandé que la qualité de l'équilibrage (avec le mandrin) soit au moins conforme à la norme G6.3 (norme ISO1940), il est également conseillé de remplacer les vis de serrage lors du changement des plaquettes. Pour des raisons de sécurité, assurez-vous également que les outils sont utilisés dans une zone fermée.

Remarque 1) La qualité de l'équilibrage du porte-outil (sans plaquette ni vis de serrage) est conforme à la norme G6.3 ou mieux, à 10,000min⁻¹.

Tableau 2 Rotation maximale sans équilibrage

AXD4000

Diamètre de l'arête de coupe DC(mm)	ø25	ø32	ø40	ø50	ø63	ø80	ø100	ø125
Vitesse de rotation maxi. recommandée (min ⁻¹)	12000	9500	7600	6000	4800	3800	3000	2400

AXD7000

Diamètre de l'arête de coupe DC(mm)	ø32	ø40	ø50	ø63	ø80	ø100	ø125
Vitesse de rotation maxi. recommandée (min ⁻¹)	9500	7600	6000	4800	3800	3000	2400

- Lorsque vous définissez la vitesse de la broche, tenez compte de la vitesse maximale autorisée du mandrin.
- Utilisez les vis spécifiées lorsque vous utilisez le mandrin avec les trous de lubrification.
- Les plaquettes ont des angles de coupe très vifs. Ne les manipulez pas à mains nues, vous risqueriez de vous blesser. Veillez à toujours porter des gants de protection lorsque vous manipulez des plaquettes indexables.

CONDITIONS DE COUPE RECOMMANDÉES

■ Vitesse de coupe

Matière		Nuance	Brise-copeaux	Vitesse de coupe V_c (m/min)	
N	Alliage aluminium	Si<5%	LC15TF	GL	1000 (200–3000)
			TF15	GL	1000 (200–3000)
		5%≤Si≤10% Si>10%	LC15TF	GL	1000 (200–3000)

■ Profondeur de Passe / Avance par Dent

Matière	Brise-copeaux	Largeur de coupe ae (mm)	Profondeur de Passe ap (mm)	Avance par dent (mm/dent)						
				Diamètre de l'arête de coupe DC (mm)						
				32	40	50, 63, 80	100, 125			
N	Alliage aluminium	Si<5%	GL	≤0.25 DC	≤ 5	≤ 0.35	≤ 0.4	≤ 0.4	≤ 0.4	
					≤ 10	≤ 0.3	≤ 0.35	≤ 0.35	≤ 0.35	
					≤ 15	≤ 0.25	≤ 0.3	≤ 0.3	≤ 0.3	
				≤ 20	≤ 0.2	≤ 0.25	≤ 0.25	≤ 0.25		
				≤0.5 DC	≤ 5	≤ 0.35	≤ 0.35	≤ 0.4	≤ 0.4	
					≤ 10	≤ 0.3	≤ 0.3	≤ 0.35	≤ 0.35	
			≤ 15		≤ 0.25	≤ 0.25	≤ 0.3	≤ 0.3		
			≤0.75 DC	≤ 5	≤ 0.3	≤ 0.3	≤ 0.35	≤ 0.35		
				≤ 10	≤ 0.25	≤ 0.25	≤ 0.3	≤ 0.3		
				≤ 15	≤ 0.2	≤ 0.2	≤ 0.25	≤ 0.25		
			DC (rainure)	≤ 5	≤ 0.25	≤ 0.3	≤ 0.35	≤ 0.35		
				≤ 10	≤ 0.2	≤ 0.25	≤ 0.3	≤ 0.3		
		≤ 15		≤ 0.15	≤ 0.2	≤ 0.25	≤ 0.25			
		≤ 20		≤ 0.1	≤ 0.15	≤ 0.2	≤ 0.2			
		5%≤Si≤10% Si>10%		GL	≤0.25 DC	≤ 5	≤ 0.35	≤ 0.4	≤ 0.4	≤ 0.4
						≤ 10	≤ 0.3	≤ 0.35	≤ 0.35	≤ 0.35
			≤ 15			≤ 0.25	≤ 0.3	≤ 0.3	≤ 0.3	
			≤ 20		≤ 0.2	≤ 0.25	≤ 0.25	≤ 0.25		
			≤0.5 DC		≤ 5	≤ 0.35	≤ 0.35	≤ 0.4	≤ 0.4	
					≤ 10	≤ 0.3	≤ 0.3	≤ 0.35	≤ 0.35	
				≤ 15	≤ 0.25	≤ 0.25	≤ 0.3	≤ 0.3		
			≤0.75 DC	≤ 5	≤ 0.3	≤ 0.3	≤ 0.35	≤ 0.35		
				≤ 10	≤ 0.25	≤ 0.25	≤ 0.3	≤ 0.3		
				≤ 15	≤ 0.2	≤ 0.2	≤ 0.25	≤ 0.25		
DC (rainure)	≤ 5		≤ 0.25	≤ 0.3	≤ 0.35	≤ 0.35				
	≤ 10		≤ 0.2	≤ 0.25	≤ 0.3	≤ 0.3				
	≤ 15	≤ 0.15	≤ 0.2	≤ 0.25	≤ 0.25					
	≤ 20	≤ 0.1	≤ 0.15	≤ 0.2	≤ 0.2					

Remarque 1) Les conditions de coupe ci-dessus sont déterminées pour une machine et une pièce de haute rigidité, sans vibrations.

En cas de vibrations, veuillez ajuster les conditions d'usinage.

Remarque 2) Des vibrations peuvent survenir dans les conditions suivantes :

- Lors d'un porte-à-faux important.
- Lors d'usinage de poche, rayon de pointe.
- Lorsque la pièce a une mauvaise fixation ou que la machine a une faible rigidité, des vibrations peuvent apparaître facilement, Si c'est le cas, de réduire les conditions de coupe tels que la largeur et la profondeur de coupe et avance par dent.

K

FRAISES À PLAQUETTES

FRAISES À PLAQUETTES

■ RAMPING/INTERPOLATION HÉLICOÏDALE

● RAMPING

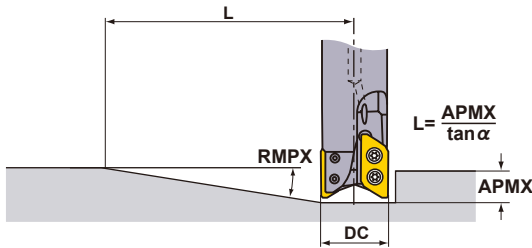

● INTERPOLATION HÉLICOÏDALE

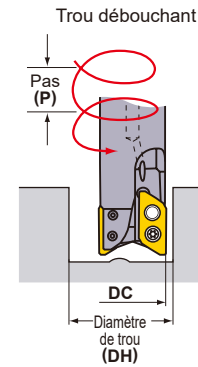

K

FRAISES À PLAQUETTES

RAMPING/INTERPOLATION HÉLICOÏDALE (ALLIAGE ALUMINIUM)

Type	DC (mm)	RE (mm)	Ramping	
			RMPX	L (mm) *1
Type A	32	0.8 - 2.4	19°	61
		3, 3,2	18°	65
	40	0.8 - 2.4	14°	85
		3, 3,2	13°	91
	50	0.8 - 2.4	10°	120
		3, 3,2	9°	133
	63	0.8 - 2.4	8°	150
		3, 3,2	7°	172
80	0.8 - 2.4	6°	200	
	3, 3,2	5°	241	
100	0.8 - 2.4	4°	301	
	3, 3,2	4°	301	
125	0.8 - 2.4	3°	401	
	3, 3,2	3°	401	
Type B	32	4, 5	18°	63
	40	4, 5	11°	105
	50	4, 5	8°	146
	63	4, 5	6°	195
	80	4, 5	4°	292
	100	4, 5	3°	390
125	4, 5	2°	585	

Type	DC (mm)	RE (mm)	Interpolation hélicoïdale	
			DH min. (mm)	P max. (mm)
Type A	32	0.8 - 2.4	41	8
		3, 3,2	41	7
	40	0.8 - 2.4	57	10
		3, 3,2	57	9
	50	0.8 - 2.4	77	12
		3, 3,2	77	11
	63	0.8 - 2.4	103	13
		3, 3,2	103	12
80	0.8 - 2.4	137	14	
	3, 3,2	137	12	
100	0.8 - 2.4	177	14	
	3, 3,2	177	13	
125	0.8 - 2.4	227	15	
	3, 3,2	227	13	
Type B	32	4	41	7
		5	41	6
	40	4	57	9
		5	57	8
	50	4	77	10
		5	77	9
	63	4	103	10
		5	103	10
	80	4	137	11
		5	137	10
	100	4	177	11
		5	177	10
125	4	227	11	
	5	227	11	

Remarque 1) L'avance recommandée de ramping est de 0.05mm/dent ou moins.

Le ramping, le fraisage hélicoïdal et le perçage ne sont pas recommandés lors de l'usinage d'acier et de titane.

*1 L (Profondeur de Passe max. = $15 / \tan \alpha$). Distance pour atteindre la profondeur de passe maximale APMX à l'angle de ramping maximal RMPX.

Profondeur de coupe maximum de type A est 21mm, type B est 20.4mm.

*2 Le diamètre maximum lors d'usinage de trou borgne à fond plat en utilisant un rayon de 0.8mm pour le type A et 4mm pour le type B.

Pour les autres rayons, utiliser la formule suivante :

$\{(\text{diamètre de coupe DC}) - (\text{Rayon de pointe}) - 0.3\} \times 2$

*3 Le diamètre minimum lors d'usinage de trou borgne à fond plat en utilisant un rayon de 0.8mm pour le type A et 4mm pour le type B.

Pour les autres rayons, utiliser la formule suivante :

$\{(\text{diamètre de coupe DC}) - (\text{Rayon de pointe}) - (\text{Largeur plat de planage BS}) - 0.1\} \times 2$

■ Prof. de Perçage Max. (Alliage aluminium)

Type	Rayon plaquette RE (mm)	Prof. de Perçage Max. (mm)
Type A	0.8 - 2.4	5
	3, 3,2	4.5
Type B	4	4
	5	3.5

AXD7000 peut être utilisée pour le perçage et l'ouverture de poche avec le même outil.

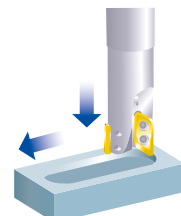

● INTERPOLATION
HÉLICOÏDALE

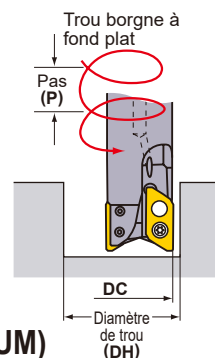

RAMPING/INTERPOLATION HÉLICOÏDALE (ALLIAGE ALUMINIUM)

Type	DC (mm)	RE (mm)	BS (mm)	Interpolation hélicoïdale (Trou borgne à fond plat)			
				DH max. (mm) *2	P max. (mm)	DH min. (mm) *3	P max. (mm)
Type A	32	0.8	2	61.9	20	58.3	20
		1.6	1.2	60.3	19	58.3	19
		2	0.8	59.5	18	58.3	18
		2.4	0.4	58.7	18	58.3	18
		3	0.8	57.5	17	56.2	17
	40	3.2	0.6	57.1	17	56.2	17
		0.8	2	77.9	20	74.3	20
		1.6	1.2	76.3	19	74.3	19
		2	0.8	75.5	18	74.3	18
		2.4	0.4	74.7	18	74.3	18
	50	3	0.8	73.5	17	72.2	17
		3.2	0.6	73.1	17	72.2	17
		0.8	2	97.5	20	94.1	20
		1.6	1.2	95.9	19	94.1	19
		2	0.8	95.1	18	94.1	18
	63	2.4	0.4	94.3	18	94.1	18
		3	0.8	93.1	17	92.1	17
		3.2	0.6	92.7	17	92.1	17
		0.8	2	123.5	20	120.1	19
		1.6	1.2	121.9	19	120.1	19
	80	2	0.8	121.1	18	120.1	18
		2.4	0.4	120.3	18	120.1	18
		3	0.8	119.1	17	118	16
		3.2	0.6	118.7	17	118	16
		0.8	2	157.5	19	154.1	18
	100	1.6	1.2	155.9	19	154.1	18
		2	0.8	155.1	18	154.1	18
		2.4	0.4	154.3	18	154.1	18
3		0.8	153.1	16	152	16	
3.2		0.6	152.7	16	152	16	
125	0.8	2	197.5	18	194.1	18	
	1.6	1.2	195.9	18	194.1	18	
	2	0.8	195.1	18	194.1	18	
	2.4	0.4	194.3	18	194.1	18	
	3	0.8	193.1	15	192	15	
Type B	32	4	0.9	55.5	16	54	16
		5	0.4	53.5	15	53.1	15
	40	4	0.9	71.5	16	70	16
		5	0.4	69.5	15	69	14
	50	4	0.9	91.1	15	89.8	15
5		0.4	89.1	14	88.9	14	
63	4	0.9	117.1	14	115.8	14	
	5	0.4	115.1	13	114.9	13	
80	4	0.9	151.1	14	149.8	13	
	5	0.4	149.1	12	148.9	12	
100	4	0.9	191.1	13	189.8	13	
	5	0.4	189.1	12	188.8	12	
125	4	0.9	241.1	13	239.8	13	
	5	0.4	239.1	12	238.8	12	

Remarque 1) L'avance recommandée de ramping est de 0.05mm/dent ou moins.

*1 L (Profondeur de Passe max. = $15 / \tan \alpha$). Distance de déplacement des fraises jusqu'à atteindre une profondeur de coupe de APMX à l'angle de ramping maximum.

Profondeur de coupe maximum de type A est 21mm, type B est 20.4mm.

*2 Le diamètre maximum lors d'usinage de trou borgne à fond plat en utilisant un rayon de 0.8mm pour le type A et 4mm pour le type B. Si l'angle est différent, utilisez la formule suivante.

$$\{(\text{diamètre de coupe DC}) - (\text{Rayon de pointe}) - 0.3\} \times 2$$

*3 Le diamètre minimum lors d'usinage de trou borgne à fond plat en utilisant un rayon de 0.8mm pour le type A et 4mm pour le type B. Si l'angle est différent, utilisez la formule suivante.

$$\{(\text{diamètre de coupe DC}) - (\text{Rayon de pointe}) - (\text{Largeur plat de planage BS}) - 0.1\} \times 2$$

FRAISES À PLAQUETTES

FRAISES MULTI FONCTIONS



AQX

- P M K N S H

K

FRAISES À PLAQUETTES



Fig.1



Nombre de dents : 4

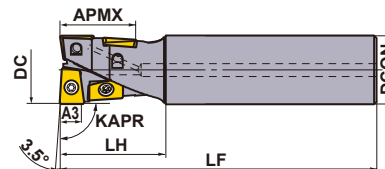
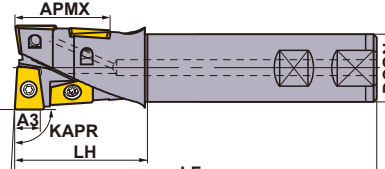

Fig.2



Nombre de dents : 4



Outil à droite uniquement.

SÉRIE STANDARD (4 PLAQUETTES)

KAPR : 90°

Type	Référence	Stock	Trou d'arrosage	Dimensions (mm)					Type (Fig.)	*3	Vis de fixation	Clé	Plaquette
				DC	LF	DCON	LH	A3*1					
Standard	AQXR164SA16S	●	○	16	120	16	30	4.5	17.6	1	TS2A	①TKY06F	QOG/MT0830R-G1/M2
	AQXR164SN16S	★	—	16	120	16	30	4.5	17.6	1	TS2A	①TKY06F	
	AQXR174SA16S	●	○	17	120	16	30	4.5	17.6	1	TS2A	①TKY06F	
	AQXR174SN16S	★	—	17	120	16	30	4.5	17.6	1	TS2A	①TKY06F	
	AQXR204SA20S	●	○	20	130	20	35	6	22	1	TS25	①TKY08F	QOG/MT1035R-G1/M2
	AQXR204SN20S	★	—	20	130	20	35	6	22	1	TS25	①TKY08F	
	AQXR214SA20S	●	○	21	130	20	35	6	22	1	TS25	①TKY08F	
	AQXR214SN20S	★	—	21	130	20	35	6	22	1	TS25	①TKY08F	
	AQXR254SA25S	●	○	25	140	25	40	7.5	27.5	1	TS33	②TKY08D	QOG/MT1342R-G1/M2
	AQXR254SN25S	★	—	25	140	25	40	7.5	27.5	1	TS33	②TKY08D	
	AQXR264SA25S	●	○	26	140	25	40	7.5	27.5	1	TS33	②TKY08D	
	AQXR264SN25S	★	—	26	140	25	40	7.5	27.5	1	TS33	②TKY08D	
	AQXR324SA32S	●	○	32	150	32	50	9.5	35.2	1	TS407	②TKY15D	QOG/MT1651R-G1/M2
	AQXR324SN32S	★	—	32	150	32	50	9.5	35.2	1	TS407	②TKY15D	
	AQXR334SA32S	●	○	33	150	32	50	9.5	35.2	1	TS407	②TKY15D	
	AQXR334SN32S	★	—	33	150	32	50	9.5	35.2	1	TS407	②TKY15D	
	AQXR354SA32S	●	○	35	150	32	50	11	40	1	TS407	②TKY15D	QOG/MT1856R-G1/M2
	AQXR354SN32S	★	—	35	150	32	50	11	40	1	TS407	②TKY15D	
	AQXR404SA32S	●	○	40	160	32	60	12	44	1	TS55	②TKY25D	QOG/MT2062R-G1/M2
	AQXR404SN32S	★	—	40	160	32	60	12	44	1	TS55	②TKY25D	
AQXR504WA40S	●	○	50	170	40	70	15	55	2	TS6S	③TKY30T	QOG/MT2576R-G1/M2	
AQXR504SA42S	★	○	50	170	42	70	15	55	1	TS6S	③TKY30T		
AQXR504SN42S	★	—	50	170	42	70	15	55	1	TS6S	③TKY30T		
AQXR164SA16L	●	○	16	175	16	50	4.5	17.6	1	TS2A	①TKY06F		QOG/MT0830R-G1/M2
AQXR164SN16L	★	—	16	175	16	50	4.5	17.6	1	TS2A	①TKY06F		
AQXR174SA16L	●	○	17	175	16	30	4.5	17.6	1	TS2A	①TKY06F		
AQXR174SN16L	★	—	17	175	16	30	4.5	17.6	1	TS2A	①TKY06F		
AQXR204SA20L	●	○	20	185	20	60	6	22	1	TS25	①TKY08F	QOG/MT1035R-G1/M2	
AQXR204SN20L	★	—	20	185	20	60	6	22	1	TS25	①TKY08F		
AQXR214SA20L	●	○	21	185	20	35	6	22	1	TS25	①TKY08F		
AQXR214SN20L	★	—	21	185	20	35	6	22	1	TS25	①TKY08F		
AQXR254SA25L	●	○	25	220	25	75	7.5	27.5	1	TS33	②TKY08D	QOG/MT1342R-G1/M2	
AQXR254SN25L	★	—	25	220	25	75	7.5	27.5	1	TS33	②TKY08D		
AQXR264SA25L	●	○	26	220	25	40	7.5	27.5	1	TS33	②TKY08D		
AQXR264SN25L	★	—	26	220	25	40	7.5	27.5	1	TS33	②TKY08D		
AQXR324SA32L	●	○	32	230	32	90	9.5	35.2	1	TS407	②TKY15D	QOG/MT1651R-G1/M2	
AQXR324SN32L	★	—	32	230	32	90	9.5	35.2	1	TS407	②TKY15D		
AQXR334SA32L	●	○	33	230	32	50	9.5	35.2	1	TS407	②TKY15D		
AQXR334SN32L	★	—	33	230	32	50	9.5	35.2	1	TS407	②TKY15D		
AQXR354SA32L	●	○	35	230	32	50	11	40	1	TS407	②TKY15D	QOG/MT1856R-G1/M2	
AQXR354SN32L	★	—	35	230	32	50	11	40	1	TS407	②TKY15D		
AQXR404SA32L	●	○	40	240	32	60	12	44	1	TS55	②TKY25D	QOG/MT2062R-G1/M2	
AQXR404SN32L	★	—	40	240	32	60	12	44	1	TS55	②TKY25D		
AQXR504WA40L	●	○	50	250	40	70	15	55	2	TS6S	③TKY30T	QOG/MT2576R-G1/M2	
AQXR504SA42L	★	○	50	250	42	70	15	55	1	TS6S	③TKY30T		
AQXR504SN42L	★	—	50	250	42	70	15	55	1	TS6S	③TKY30T		

*1 A3 représente la profondeur de passe quand la fraise a 2 plaquettes.

*2 APMX: Profondeur de Passe max.

*3 Couple de serrage (N • m) : TS2A=0,6, TS25=1,0, TS33=1,0, TS407=3,5, TS55=7,5, TS6S=10,0

● : Article stocké. ★ : Article standard Japon.



Fig.1



Nombre de dents : 2

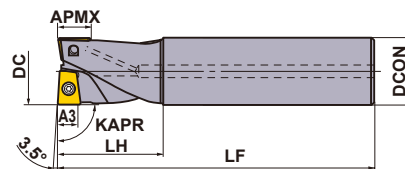
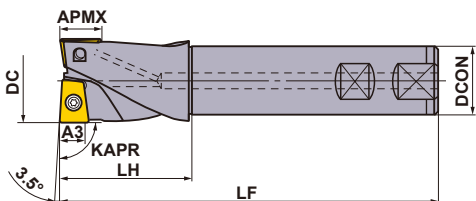

Fig.2



Nombre de dents : 2



■ SÉRIE COURTE (2 PLAQUETTES)

KAPR : 90°

Outil à droite uniquement.

Type	Référence	Stock	Trou d'arrosage	Dimensions (mm)						Type (Fig.)	*3	① ② ③	Plaque
				DC	LF	DCON	LH	A3 *1	APMX *2				
Standard	AQXR162SA16S	●	○	16	120	16	30	4.5	7.4	1	TS2A	①TKY06F	QOG/MT0830R-G1/M2
	AQXR162SN16S	★	—	16	120	16	30	4.5	7.4	1	TS2A	①TKY06F	
	AQXR172SA16S	●	○	17	120	16	30	4.5	7.4	1	TS2A	①TKY06F	
	AQXR172SN16S	★	—	17	120	16	30	4.5	7.4	1	TS2A	①TKY06F	
	AQXR202SA20S	●	○	20	130	20	35	6	9.2	1	TS25	①TKY08F	QOG/MT1035R-G1/M2
	AQXR202SN20S	★	—	20	130	20	35	6	9.2	1	TS25	①TKY08F	
	AQXR212SA20S	●	○	21	130	20	35	6	9.2	1	TS25	①TKY08F	
	AQXR212SN20S	★	—	21	130	20	35	6	9.2	1	TS25	①TKY08F	
	AQXR252SA25S	●	○	25	140	25	40	7.5	11.5	1	TS33	②TKY08D	QOG/MT1342R-G1/M2
	AQXR252SN25S	★	—	25	140	25	40	7.5	11.5	1	TS33	②TKY08D	
	AQXR262SA25S	●	○	26	140	25	40	7.5	11.5	1	TS33	②TKY08D	
	AQXR262SN25S	★	—	26	140	25	40	7.5	11.5	1	TS33	②TKY08D	
	AQXR322SA32S	●	○	32	150	32	50	9.5	14.5	1	TS407	②TKY15D	QOG/MT1651R-G1/M2
	AQXR322SN32S	★	—	32	150	32	50	9.5	14.5	1	TS407	②TKY15D	
	AQXR332SA32S	●	○	33	150	32	50	9.5	14.5	1	TS407	②TKY15D	
	AQXR332SN32S	★	—	33	150	32	50	9.5	14.5	1	TS407	②TKY15D	
	AQXR352SA32S	●	○	35	150	32	50	11	16	1	TS407	②TKY15D	QOG/MT1856R-G1/M2
	AQXR352SN32S	★	—	35	150	32	50	11	16	1	TS407	②TKY15D	
	AQXR402SA32S	●	○	40	160	32	60	12	18	1	TS55	②TKY25D	QOG/MT2062R-G1/M2
	AQXR402SN32S	★	—	40	160	32	60	12	18	1	TS55	②TKY25D	
AQXR502WA40S	●	○	50	170	40	70	15	23	2	TS6S	③TKY30T	QOG/MT2576R-G1/M2	
AQXR502SA42S	★	○	50	170	42	70	15	23	1	TS6S	③TKY30T		
AQXR502SN42S	★	—	50	170	42	70	15	23	1	TS6S	③TKY30T		
AQXR502SN42S	★	—	50	170	42	70	15	23	1	TS6S	③TKY30T		
Série longue	AQXR162SA16L	●	○	16	175	16	50	4.5	7.4	1	TS2A	①TKY06F	QOG/MT0830R-G1/M2
	AQXR162SN16L	★	—	16	175	16	50	4.5	7.4	1	TS2A	①TKY06F	
	AQXR172SA16L	●	○	17	175	16	30	4.5	7.4	1	TS2A	①TKY06F	
	AQXR172SN16L	★	—	17	175	16	30	4.5	7.4	1	TS2A	①TKY06F	
	AQXR202SA20L	●	○	20	185	20	60	6	9.2	1	TS25	①TKY08F	QOG/MT1035R-G1/M2
	AQXR202SN20L	★	—	20	185	20	60	6	9.2	1	TS25	①TKY08F	
	AQXR212SA20L	●	○	21	185	20	35	6	9.2	1	TS25	①TKY08F	
	AQXR212SN20L	★	—	21	185	20	35	6	9.2	1	TS25	①TKY08F	
	AQXR252SA25L	●	○	25	220	25	75	7.5	11.5	1	TS33	②TKY08D	QOG/MT1342R-G1/M2
	AQXR252SN25L	★	—	25	220	25	75	7.5	11.5	1	TS33	②TKY08D	
	AQXR262SA25L	●	○	26	220	25	40	7.5	11.5	1	TS33	②TKY08D	
	AQXR262SN25L	★	—	26	220	25	40	7.5	11.5	1	TS33	②TKY08D	
	AQXR322SA32L	●	○	32	230	32	90	9.5	14.5	1	TS407	②TKY15D	QOG/MT1651R-G1/M2
	AQXR322SN32L	★	—	32	230	32	90	9.5	14.5	1	TS407	②TKY15D	
	AQXR332SA32L	●	○	33	230	32	50	9.5	14.5	1	TS407	②TKY15D	
	AQXR332SN32L	★	—	33	230	32	50	9.5	14.5	1	TS407	②TKY15D	
	AQXR352SA32L	●	○	35	230	32	50	11	16	1	TS407	②TKY15D	QOG/MT1856R-G1/M2
	AQXR352SN32L	★	—	35	230	32	50	11	16	1	TS407	②TKY15D	
	AQXR402SA32L	●	○	40	240	32	60	12	18	1	TS55	②TKY25D	QOG/MT2062R-G1/M2
	AQXR402SN32L	★	—	40	240	32	60	12	18	1	TS55	②TKY25D	
AQXR502WA40L	●	○	50	250	40	70	15	23	2	TS6S	③TKY30T	QOG/MT2576R-G1/M2	
AQXR502SA42L	★	○	50	250	42	70	15	23	1	TS6S	③TKY30T		
AQXR502SN42L	★	—	50	250	42	70	15	23	1	TS6S	③TKY30T		
AQXR502SN42L	★	—	50	250	42	70	15	23	1	TS6S	③TKY30T		

*1 A3 représente la profondeur de passe quand la fraise a 2 plaquettes.

*2 APMX: Profondeur de Passe max.

*3 Couple de serrage (N • m) : TS2A=0,6, TS25=1,0, TS33=1,0, TS407=3,5, TS55=7,5, TS6S=10,0

FRAISES À PLAQUETTES

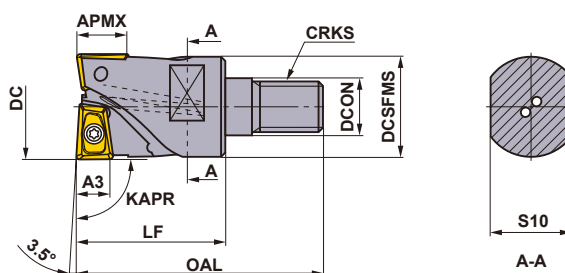
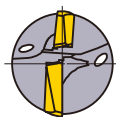

K

FRAISES À PLAQUETTES

■ FRAISE À EMBOUT FILETÉ

KAPR :90°

Outil à droite uniquement.

Référence	Stock		Dimensions (mm)									*4 WT (kg)	*3 		
	R	Trou d'alorsage	DC	DCON	DCSFMS	OAL	LF	S10	CRKS	A3*1	APMX*2				
AQXR162M08A30	●	○	16	8.5	14.7	48	30	10	M8	4.5	7.4	0.1	TS2A	①TKY06F	QO○T0830R-○○
AQXR172M08A30	●	○	17	8.5	14.5	48	30	10	M8	4.5	7.4	0.1	TS2A	①TKY06F	QO○T1035R-○○
AQXR202M10A30	●	○	20	10.5	18.6	49	30	14	M10	6	9.2	0.2	TS25	①TKY08F	QO○T1342R-○○
AQXR212M10A30	●	○	21	10.5	18.5	49	30	14	M10	6	9.2	0.2	TS25	①TKY08F	QO○T1651R-○○
AQXR252M12A35	●	○	25	12.5	23.5	57	35	19	M12	7.5	11.5	0.2	TS33	②TKY08D	QO○T1856R-○○
AQXR262M12A35	●	○	26	12.5	23.5	57	35	19	M12	7.5	11.5	0.2	TS33	②TKY08D	QO○T2062R-○○
AQXR322M16A40	●	○	32	17	28.5	63	40	24	M16	9.5	14.5	0.3	TS407	②TKY15D	
AQXR332M16A40	●	○	33	17	28.5	63	40	24	M16	9.5	14.5	0.3	TS407	②TKY15D	
AQXR352M16A40	●	○	35	17	28.5	63	40	24	M16	11	16	0.3	TS407	②TKY15D	
AQXR402M16A45	●	○	40	17	28.5	68	45	24	M16	12	18	0.3	TS55	②TKY25D	

Remarque 1) Pour les arbres vissables, veuillez vous référer à la page K244.



*1 A3 représente la profondeur de passe quand la fraise a 2 plaquettes.

*2 APMX: Profondeur de Passe max.

*3 Couple de serrage (N • m) : TS2A=0,6, TS25=1,0, TS33=1,0, TS407=3,5, TS55=7,5

*4 WT : Poids de l'outil

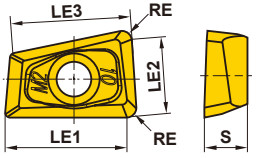
PLAQUETTES

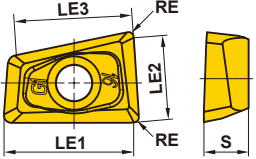
Matière	<table border="1"> <tr><td>P</td><td>Acier</td><td>●</td><td>●</td><td></td><td></td><td></td><td></td><td></td><td></td><td></td><td></td><td></td><td></td><td></td><td></td><td></td><td></td><td></td><td></td></tr> <tr><td>M</td><td>Acier Inoxydable</td><td></td><td></td><td>●</td><td>●</td><td></td><td></td><td></td><td></td><td></td><td></td><td></td><td></td><td></td><td></td><td></td><td></td><td></td><td></td><td></td></tr> <tr><td>K</td><td>Fonte</td><td></td><td></td><td></td><td></td><td>●</td><td>●</td><td></td><td></td><td></td><td></td><td></td><td></td><td></td><td></td><td></td><td></td><td></td><td></td><td></td></tr> <tr><td>N</td><td>Non ferreux</td><td></td><td></td><td></td><td></td><td></td><td></td><td>●</td><td>●</td><td></td><td></td><td></td><td></td><td></td><td></td><td></td><td></td><td></td><td></td><td></td></tr> <tr><td>S</td><td>Alliage réfractaire, Alliage titane</td><td></td><td></td><td></td><td></td><td></td><td></td><td></td><td></td><td>●</td><td>●</td><td></td><td></td><td></td><td></td><td></td><td></td><td></td><td></td><td></td></tr> <tr><td>H</td><td>Matériaux durs</td><td></td><td></td><td></td><td></td><td></td><td></td><td></td><td></td><td></td><td></td><td>●</td><td>●</td><td></td><td></td><td></td><td></td><td></td><td></td><td></td></tr> </table>					P	Acier	●	●																	M	Acier Inoxydable			●	●																K	Fonte					●	●														N	Non ferreux							●	●												S	Alliage réfractaire, Alliage titane									●	●										H	Matériaux durs											●	●								Conditions de coupe (Guide) : ● : Coupe Stable ● : Coupe Générale ✖ : Coupe Instable Honing : E : Ronde F : Affûtée										Forme	Référence	DC	Classe Honing	Revêtu						Carbure	Dimensions (mm)					Géométrie
	P	Acier	●	●																																																																																																																																																									
M	Acier Inoxydable			●	●																																																																																																																																																								
K	Fonte					●	●																																																																																																																																																						
N	Non ferreux							●	●																																																																																																																																																				
S	Alliage réfractaire, Alliage titane									●	●																																																																																																																																																		
H	Matériaux durs											●	●																																																																																																																																																
MP6120	MP6130	MP7130	MP7140	MP9120	VP15TF	VP30RT	HTi10	LE1	LE2	LE3	S	RE																																																																																																																																																	
	QOMT0830R-M2	φ 16,17	M E	●	●	●	●	●	●												7.3	4.4	7.3	3	0.8																																																																																																																																				
	QOMT1035R-M2	φ 20,21	M E	●	●	●	●	●	●													9.5	5.9	9.3	3.5		0.8																																																																																																																																		
	QOMT1342R-M2	φ 25,26	M E	●	●	●	●	●	●														12	7.6	11.6		4.2	0.8																																																																																																																																	
	QOMT1651R-M2	φ 32,33	M E	●	●	●	●	●	●														15.4	9.9	14.6		5.1	0.8																																																																																																																																	
	QOMT1856R-M2	φ 35	M E	●	●	●	●	●	●														16.9	10.9	16		5.6	0.8																																																																																																																																	
	QOMT2062R-M2	φ 40	M E	●	●	●	●	●	●														19.4	12.6	18.1		6.2	0.8																																																																																																																																	
	QOMT2576R-M2	φ 50	M E	●	●	●	●	●	●														24.8	16.1	23.1		7.6	0.8																																																																																																																																	
	QOGT0830R-G1	φ 16,17	G E* ★					★	●	●												7.7	4.9	7.3	3	0.4																																																																																																																																			
	QOGT1035R-G1	φ 20,21	G E* ★					★	●	●												9.9	6.4	9.3	3.5	0.4																																																																																																																																			
	QOGT1342R-G1	φ 25,26	G E* ★					★	●	●													12.4	8.1	11.6	4.2		0.4																																																																																																																																	
	QOGT1651R-G1	φ 32,33	G E* ★					★	●	●													15.8	10.4	14.6	5.1		0.4																																																																																																																																	
	QOGT1856R-G1	φ 35	G E* ★					★	●	●													17.3	11.4	16	5.6		0.4																																																																																																																																	
	QOGT2062R-G1	φ 40	G E* ★					★	●	●													19.8	13.1	18.1	6.2		0.4																																																																																																																																	
	QOGT2576R-G1	φ 50	G E* ★					★	●	●													25.2	16.6	23.1	7.6		0.4																																																																																																																																	

* Les plaquettes en nuances HTi10 ont une préparation "F".

CONDITIONS DE COUPE RECOMMANDÉES

■ VITESSE DE COUPE

Matière	No.	Dureté	Brise-copeaux	Vitesses de coupe pour différentes nuances Vc (m/min)			
P				MP6120	VP15TF	MP6130	
	Acier doux	1	≤180HB	M2/G1	200 (170–240)	180 (150–220)	160 (130–200)
	Acier carbone, Acier allié	2	180–350HB	M2	180 (140–220)	160 (120–200)	140 (100–180)
M				MP7130	MP7140	VP30RT(VP15TF)	
	Acier inoxydable austénitique	1	≤200HB	M2/G1	170 (120–200)	160 (100–180)	150 (120–180)
	Acier inoxydable austénitique	2	>200HB	M2			
	Acier inoxydable ferritique ou martensitique	3	≤200HB	M2			
Acier inoxydable ferritique ou martensitique	4	>200HB	M2				
K				VP15TF			
	Fonte grise	1	≤350MPa	M2	180 (150–220)	–	–
	Fonte ductile	2	≤450MPa	M2	180 (150–220)	–	–
N				HTi10			
	Alliage aluminium	1	Si < 5%	G1	500 (200–800)	–	–
	Alliage aluminium	2	5% ≤ Si ≤ 10%	G1	100 (50–300)	–	–
	Alliage aluminium	3	Si > 5%	G1	100 (50–300)	–	–
S				MP9120			
Alliage titane *	1	–	M2	50 (30–70)	–	–	
H				VP15TF			
Acier Traité	1	40–55HRC	M2	80 (50–120)	–	–	

* L'usinage sous arrosage est recommandé pour les alliages de titane.

PIÈCES DÉTACHÉES > N001
DONNÉES TECHNIQUES > P001

FRAISES À PLAQUETTES

CONDITIONS DE COUPE RECOMMANDÉES

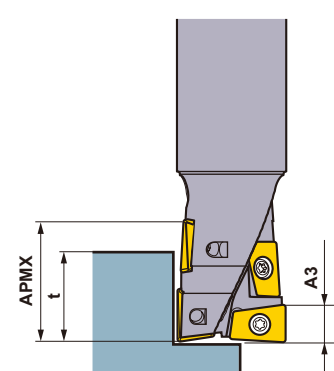

- A3 est la profondeur de coupe avec deux dents effectives.
- Au-delà d'A3 (plage de chevauchement), il y a une zone avec une dent effective. Pour cette raison, faites particulièrement attention à l'avance en fonction de la profondeur de passe.
- En général, l'endommagement de l'arête se trouve au niveau de la profondeur de passe t. En cas de grande profondeur de coupe, il est recommandé d'appliquer la profondeur de coupe t (cf ci-dessous) à laquelle la fraise fonctionne avec deux dents effectives pour éviter tout endommagement de l'arête de coupe. (mm)

Diamètre outil	Recommandation des profondeurs de coupe t (mm)
φ 16,17	12 – 14
φ 20,21	14 – 17
φ 25,26	17 – 22
φ 32,33	22 – 28
φ 35	25 – 32
φ 40	28 – 35
φ 50	35 – 45

* Les valeurs pour A3 et APMX sont données dans les tableaux des corps standard des pages précédentes.

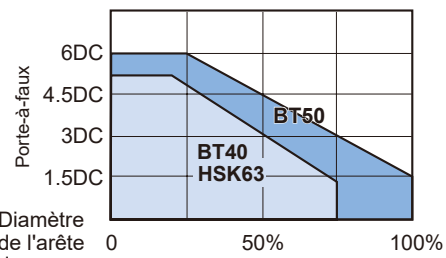

* DC = Diamètre de l'arête de coupe

- Des vibrations et des écaillages de plaquette peuvent survenir lors de l'usinage avec un grand porte-à-faux et cas de faible raideur de machine ou de pièce.
- Dans ce cas, réduire l'avance selon l'abaque ci-dessus.

CONDITIONS DE COUPE POUR FRAISAGE D'ÉPAULEMENT

Matière	No.	Dureté	φ 16, 17			φ 20, 21			φ 25, 26		
			ap (mm)	ae (mm)	fr (mm/tour)	ap (mm)	ae (mm)	fr (mm/tour)	ap (mm)	ae (mm)	fr (mm/tour)
P Acier doux	1	≤ 180HB	≤ 4.5	≤ 8	0.25	≤ 6	≤ 10	0.3	≤ 7.5	≤ 12.5	0.35
			4.5–12	≤ 5	0.16	6–14	≤ 7	0.25	7.5–17	≤ 8	0.28
			12–17	≤ 3	0.1	14–22	≤ 4	0.18	17–27	≤ 5	0.2
Acier carbone Acier allié	2	180–350HB	≤ 4.5	≤ 8	0.2	≤ 6	≤ 10	0.25	≤ 7.5	≤ 12.5	0.3
			4.5–12	≤ 4	0.14	6–14	≤ 6	0.2	7.5–17	≤ 7	0.25
			12–17	≤ 2	0.08	14–22	≤ 3	0.16	17–27	≤ 4	0.18
M Acier inoxydable	1,2,3,4	–	≤ 4.5	≤ 8	0.2	≤ 6	≤ 10	0.25	≤ 7.5	≤ 12.5	0.3
			4.5–12	≤ 4	0.14	6–14	≤ 6	0.2	7.5–17	≤ 7	0.25
			12–17	≤ 2	0.08	14–22	≤ 3	0.16	17–27	≤ 4	0.18
K Fonte	1,2	–	≤ 4.5	≤ 8	0.25	≤ 6	≤ 10	0.3	≤ 7.5	≤ 12.5	0.35
			4.5–12	≤ 5	0.16	6–14	≤ 7	0.25	7.5–17	≤ 8	0.28
			12–17	≤ 3	0.1	14–22	≤ 4	0.18	17–27	≤ 5	0.2
N Alliage aluminium	1,2,3	–	≤ 4.5	≤ 11	0.3	≤ 6	≤ 14	0.35	≤ 7.5	≤ 12.5	0.4
			4.5–12	≤ 8	0.21	6–14	≤ 10	0.3	7.5–17	≤ 7	0.33
			12–17	≤ 5	0.15	14–22	≤ 6	0.23	17–27	≤ 4	0.25
S Alliage de titane	1	–	≤ 4.5	≤ 8	0.14	≤ 6	≤ 10	0.18	≤ 7.5	≤ 17.5	0.21
			4.5–12	≤ 4	0.1	6–14	≤ 6	0.14	7.5–17	≤ 12.5	0.18
			12–17	≤ 2	0.06	14–22	≤ 3	0.11	17–27	≤ 7.5	0.13
H Acier traité	1	40–55HRC	≤ 4.5	≤ 5	0.16	≤ 6	≤ 6	0.2	≤ 7.5	≤ 7	0.22
			4.5–12	≤ 3	0.1	6–14	≤ 4	0.16	7.5–17	≤ 4	0.18
			12–17	≤ 1	0.06	14–22	≤ 2	0.12	17–27	≤ 2	0.14

Matière	No.	Dureté	φ 32, 33			φ 35			φ 40			φ 50		
			ap (mm)	ae (mm)	fr (mm/tour)	ap (mm)	ae (mm)	fr (mm/tour)	ap (mm)	ae (mm)	fr (mm/tour)	ap (mm)	ae (mm)	fr (mm/tour)
P Acier doux	1	≤ 180HB	≤ 9.5	≤ 16	0.4	≤ 11	≤ 17.5	0.45	≤ 12	≤ 20	0.5	≤ 15	≤ 25	0.6
			9.5–22	≤ 11	0.32	11–25	≤ 12	0.35	12–28	≤ 13	0.4	15–35	≤ 16	0.5
			22–35	≤ 6	0.25	25–40	≤ 6.5	0.28	28–44	≤ 7	0.3	35–55	≤ 10	0.35
Acier carbone Acier allié	2	180–350HB	≤ 9.5	≤ 16	0.35	≤ 11	≤ 17.5	0.37	≤ 12	≤ 20	0.4	≤ 15	≤ 25	0.5
			9.5–22	≤ 10	0.28	11–25	≤ 11	0.3	12–28	≤ 12	0.32	15–35	≤ 14	0.4
			22–35	≤ 5	0.2	25–40	≤ 5.5	0.22	28–44	≤ 6	0.25	35–55	≤ 8	0.3
M Acier inoxydable	1,2,3,4	–	≤ 9.5	≤ 16	0.35	≤ 11	≤ 17.5	0.37	≤ 12	≤ 20	0.4	≤ 15	≤ 25	0.5
			9.5–22	≤ 10	0.28	11–25	≤ 12	0.3	12–28	≤ 12	0.32	15–35	≤ 14	0.4
			22–35	≤ 5	0.2	25–40	≤ 6.5	0.22	28–44	≤ 6	0.25	35–55	≤ 8	0.3
K Fonte	1,2	–	≤ 9.5	≤ 16	0.4	≤ 11	≤ 17.5	0.45	≤ 12	≤ 20	0.5	≤ 15	≤ 25	0.6
			9.5–22	≤ 11	0.32	11–25	≤ 12	0.35	12–28	≤ 13	0.4	15–35	≤ 16	0.5
			22–35	≤ 6	0.25	25–40	≤ 6.5	0.28	28–44	≤ 7	0.3	35–55	≤ 10	0.35
N Alliage aluminium	1,2,3	–	≤ 9.5	≤ 16	0.45	≤ 11	≤ 17.5	0.5	≤ 12	≤ 20	0.55	≤ 15	≤ 25	0.65
			9.5–22	≤ 10	0.37	11–25	≤ 12	0.4	12–28	≤ 12	0.45	15–35	≤ 14	0.55
			22–35	≤ 5	0.3	25–40	≤ 6.5	0.32	28–44	≤ 6	0.35	35–55	≤ 8	0.4
S Alliage de titane	1	–	≤ 9.5	≤ 23	0.25	≤ 11	≤ 24.5	0.26	≤ 12	≤ 28	0.28	≤ 15	≤ 35	0.35
			9.5–22	≤ 16	0.2	11–25	≤ 17.5	0.21	12–28	≤ 20	0.22	15–35	≤ 25	0.28
			22–35	≤ 10	0.14	25–40	≤ 10.5	0.15	28–44	≤ 12	0.18	35–55	≤ 15	0.21
H Acier traité	1	40–55HRC	≤ 9.5	≤ 8	0.25	≤ 11	≤ 9	0.28	≤ 12	≤ 10	0.3	≤ 15	≤ 14	0.35
			9.5–22	≤ 5	0.2	11–25	≤ 5.5	0.22	12–28	≤ 6	0.24	15–35	≤ 8	0.3
			22–35	≤ 2	0.16	25–40	≤ 2	0.17	28–44	≤ 2	0.18	35–55	≤ 4	0.22

Remarque 1) Porter une attention particulière à la profondeur de passe avec les fraises courtes.

Remarque 2) Lors de l'usinage avec le brise-copeaux G1 (VP15TF), réduire la vitesse de 20%.

Remarque 3) Pour les vitesses de coupe, cf. page K175.

■ CONDITIONS DE COUPE POUR RAINURAGE

Matière	No.	Dureté	φ16, 17		φ20, 21		φ25, 26	
			ap (mm)	fr (mm/tour)	ap (mm)	fr (mm/tour)	ap (mm)	fr (mm/tour)
P Acier doux	1	≤180HB	≤4.5	0.16	≤6	0.18	≤7.5	0.2
			4.5–12	0.1	6–14	0.14	7.5–17	0.16
			12–17	0.07	14–22	0.1	17–27	0.12
Acier carbone Acier allié	2	180–350HB	≤4.5	0.14	≤6	0.16	≤7.5	0.18
			4.5–12	0.09	6–14	0.12	7.5–17	0.14
			12–17	0.05	14–22	0.1	17–27	0.1
M Acier inoxydable	1,2,3,4	–	≤4.5	0.14	≤6	0.16	≤7.5	0.18
			4.5–12	0.09	6–14	0.12	7.5–17	0.14
			12–17	0.05	14–22	0.1	17–27	0.1
K Fonte	1	≤350MPa	≤4.5	0.16	≤6	0.18	≤7.5	0.2
			4.5–12	0.1	6–14	0.14	7.5–17	0.16
			12–17	0.07	14–22	0.1	17–27	0.12
N Alliage aluminium	1,2,3	–	≤4.5	0.18	≤6	0.2	≤7.5	0.22
			4.5–12	0.12	6–14	0.16	7.5–17	0.18
			12–17	0.09	14–22	0.12	17–27	0.14
S Alliage de titane	1	–	≤4.5	0.1	≤6	0.12	≤7.5	0.15
			4.5–12	0.05	6–14	0.08	7.5–17	0.1
			12–17	0.03	14–22	0.05	17–27	0.08
H Acier traité	1	40–55HRC	≤4.5	0.1	≤6	0.12	≤7.5	0.14
			4.5–12	0.07	6–14	0.1	7.5–17	0.12
			–	–	–	–	–	–

Matière	No.	Dureté	φ32, 33		φ35		φ40		φ50	
			ap (mm)	fr (mm/tour)	ap (mm)	fr (mm/tour)	ap (mm)	fr (mm/tour)	ap (mm)	fr (mm/tour)
P Acier doux	1	≤180HB	≤9.5	0.25	≤11	0.27	≤12	0.3	≤15	0.35
			9.5–22	0.2	11–25	0.22	12–28	0.25	15–35	0.3
			22–35	0.14	25–40	0.16	28–44	0.18	35–55	0.22
Acier carbone Acier allié	2	180–350HB	≤9.5	0.2	≤11	0.22	≤12	0.25	≤15	0.3
			9.5–22	0.16	11–25	0.18	12–28	0.2	15–35	0.25
			22–35	0.12	25–40	0.13	28–44	0.14	35–55	0.16
M Acier inoxydable	1,2,3,4	–	≤9.5	0.2	≤11	0.22	≤12	0.25	≤15	0.3
			9.5–22	0.16	11–25	0.18	12–28	0.2	15–35	0.25
			22–35	0.12	25–40	0.13	28–44	0.14	35–55	0.16
K Fonte	1	≤350MPa	≤9.5	0.25	≤11	0.27	≤12	0.3	≤15	0.35
			9.5–22	0.2	11–25	0.22	12–28	0.25	15–35	0.3
			22–35	0.14	25–40	0.16	28–44	0.18	35–55	0.22
N Alliage aluminium	1,2,3	–	≤9.5	0.27	≤11	0.3	≤12	0.32	≤15	0.37
			9.5–22	0.22	11–25	0.25	12–28	0.27	15–35	0.32
			22–35	0.16	25–40	0.18	28–44	0.2	35–55	0.25
S Alliage de titane	1	–	≤9.5	0.18	≤11	0.2	≤12	0.23	≤15	0.25
			9.5–22	0.12	11–25	0.15	12–28	0.2	15–35	0.23
			22–35	0.1	25–40	0.12	28–44	0.15	35–55	0.18
H Acier traité	1	40–55HRC	≤9.5	0.16	≤11	0.17	≤12	0.18	≤15	0.22
			9.5–22	0.12	11–25	0.13	12–28	0.14	15–35	0.16
			–	–	–	–	–	–	–	–

Remarque 1) Porter une attention particulière à la profondeur de coupe en usinage de type court.

Remarque 2) Lors de l'usinage avec le brise-copeaux G1 (VP15TF), réduire la vitesse de 20%.

Remarque 3) Pour les vitesses de coupe, cf. page K175.

FRAISES À PLAQUETTES

CONDITIONS DE COUPE RECOMMANDÉES

■ POUR INTERPOLATION HÉLICOÏDALE

$$\varnothing dc = \varnothing DH - DC$$

Diamètre d'interpolation Diamètre de trou désiré Diamètre de coupe

$$P = \pi \times dc \times \tan \alpha^\circ$$

(Remarque) $\alpha^\circ \leq 3^\circ$

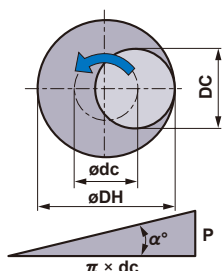
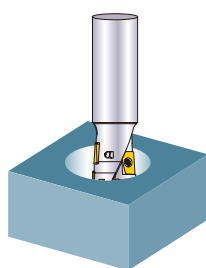

- Calcul du diamètre d'interpolation.
- Profondeur de passe.
- Diamètre min. du trou
en perçage hélicoïdal : 1.2DC
Diamètre max. du trou en perçage hélicoïdal : 1.8DC
- Pour l'évacuation des copeaux, nous conseillons le soufflage d'air.
(veuillez utiliser l'arrosage pour l'aluminium et le titane)
- Avec le brise-copeaux G1 (VP15TF), réduisez la vitesse d'avance de 20 %.

K
FRAISES À PLAQUETTES

Matière	No.	Dureté	φ16, 17				φ20, 21				φ25, 26			
			DH (mm)	APMX (mm)	fr (mm/tour)	P (mm)	DH (mm)	APMX (mm)	fr (mm/tour)	P (mm)	DH (mm)	APMX (mm)	fr (mm/tour)	P (mm)
P Acier doux	1	≤180HB	20	8	0.16	0.44	24	10	0.18	0.44	30	12.5	0.2	0.55
			25	12	0.14	0.99	30	15	0.16	1.1	38	19	0.18	1.43
			29	16	0.12	1.43	36	20	0.14	1.76	45	25	0.16	2.2
Acier carbone Alliage acier	2	180–350HB	20	8	0.14	0.33	24	10	0.16	0.33	30	12.5	0.18	0.41
			25	12	0.12	0.74	30	15	0.14	0.82	38	19	0.16	1.07
			29	16	0.1	1.07	36	20	0.12	1.32	45	25	0.14	1.65
M Acier inoxydable	1,2,3,4	—	20	3	0.14	0.22	24	4	0.16	0.22	30	5	0.18	0.27
			25	5	0.12	0.49	30	7	0.14	0.55	38	9	0.16	0.71
			29	8	0.1	0.71	36	10	0.12	0.88	45	12.5	0.14	1.1
K Fonte	1	≤350MPa	20	10	0.16	0.55	24	14	0.18	0.55	30	18	0.2	0.69
			25	13	0.14	1.23	30	17	0.16	1.37	38	21	0.18	1.78
			29	16	0.12	1.78	36	20	0.14	2.19	45	25	0.16	2.74
N Alliage aluminium	1,2,3	—	20	10	0.18	0.44	24	14	0.2	0.44	30	18	0.22	0.55
			25	13	0.16	0.99	30	17	0.18	1.1	38	21	0.2	1.43
			29	16	0.14	1.43	36	20	0.16	1.76	45	25	0.18	2.2
S Alliage de titane	1	—	20	3	0.1	0.22	24	4	0.11	0.22	30	5	0.13	0.27
			25	5	0.08	0.49	30	7	0.1	0.55	38	9	0.11	0.71
			29	8	0.07	0.71	36	10	0.08	0.88	45	12.5	0.1	1.1
H Acier traité	1	40–55HRC	20	3	0.1	0.22	24	4	0.12	0.22	30	5	0.14	0.27
			25	5	0.08	0.49	30	7	0.1	0.55	38	9	0.12	0.71
			29	8	0.06	0.71	36	10	0.08	0.88	45	12.5	0.1	1.1

Matière	No.	Dureté	φ32, 33				φ35				φ40				φ50			
			DH (mm)	APMX (mm)	fr (mm/tour)	P (mm)	DH (mm)	APMX (mm)	fr (mm/tour)	P (mm)	DH (mm)	APMX (mm)	fr (mm/tour)	P (mm)	DH (mm)	APMX (mm)	fr (mm/tour)	P (mm)
P Acier doux	1	≤180HB	38	16	0.25	0.66	42	18	0.28	0.77	48	20	0.3	0.88	60	25	0.35	1.1
			48	24	0.22	1.76	53	27	0.24	1.97	60	30	0.26	2.19	75	38	0.3	2.74
			58	32	0.2	2.85	63	35	0.21	3.07	72	40	0.22	3.51	90	50	0.26	4.39
Acier carbone Alliage acier	2	180–350HB	38	16	0.2	0.49	42	18	0.22	0.58	48	20	0.25	0.66	60	25	0.28	0.82
			48	24	0.18	1.32	53	27	0.2	1.48	60	30	0.22	1.65	75	38	0.26	2.06
			58	32	0.16	2.14	63	35	0.18	2.3	72	40	0.2	2.63	90	50	0.24	3.29
M Acier inoxydable	1,2,3,4	—	38	6	0.2	0.33	42	7	0.22	0.38	48	8	0.25	0.44	60	10	0.28	0.55
			48	11	0.18	0.88	53	13	0.2	0.99	60	14	0.22	1.1	75	18	0.26	1.37
			58	16	0.16	1.43	63	18	0.18	1.53	72	20	0.2	1.75	90	25	0.27	2.19
K Fonte	1	≤350MPa	38	22	0.25	0.82	42	25	0.28	0.95	48	28	0.3	1.1	60	35	0.35	1.37
			48	27	0.22	2.19	53	30	0.24	2.47	60	34	0.26	2.74	75	43	0.3	3.43
			58	32	0.2	3.57	63	35	0.21	3.84	72	40	0.22	4.39	90	50	0.26	5.49
N Alliage aluminium	1,2,3	—	38	22	0.27	0.66	42	25	0.3	0.77	48	28	0.32	0.88	60	35	0.37	1.1
			48	27	0.24	1.76	53	30	0.26	1.97	60	34	0.28	2.19	75	43	0.32	2.74
			58	32	0.22	2.85	63	35	0.21	3.07	72	40	0.24	3.51	90	50	0.27	4.39
S Alliage de titane	1	—	38	6	0.14	0.33	42	7	0.15	0.38	48	8	0.18	0.44	60	10	0.2	0.55
			48	11	0.13	0.88	53	13	0.14	0.99	60	14	0.15	1.1	75	18	0.18	1.37
			58	16	0.11	1.43	63	18	0.13	1.53	72	20	0.14	1.75	90	25	0.17	2.19
H Acier traité	1	40–55HRC	38	6	0.16	0.33	42	7	0.17	0.38	48	8	0.18	0.44	60	10	0.2	0.55
			48	11	0.14	0.88	53	13	0.15	0.99	60	14	0.16	1.1	75	18	0.18	1.37
			58	16	0.12	1.43	63	18	0.13	1.53	72	20	0.14	1.75	90	25	0.16	2.19

Remarque 1) Le rainurage hélicoïdal est fortement recommandé pour l'usinage des aciers trempés.

Remarque 2) Lors de l'usinage avec le brise-copeaux G1 (VP15TF), réduire la vitesse de 20%.

Remarque 3) Pour les vitesses de coupe, cf. page K175.

■ PERÇAGE ET TRÉFLAGE

● Perçage

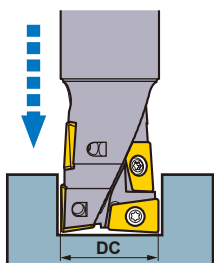

- La profondeur de perçage recommandée est inférieure à 0,5 DC.
- En perçage, avancez par pas de 0,25–0,5 mm afin d'assurer la fragmentation des copeaux.
- Utilisez l'arrosage interne ou externe pour assurer l'évacuation des copeaux.
- Les copeaux peuvent être projetés dans tous les sens, assurez-vous de prendre des mesures de sécurité adéquates.

● Tréflage

Profondeur de coupe radiale

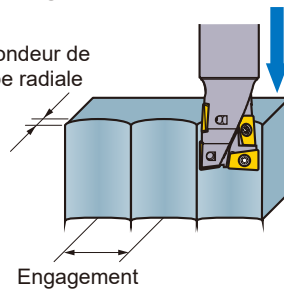

- L'avance en tréflage est la même qu'en perçage.
- Aucune cycle de brise-copeaux n'est nécessaire.
- Veuillez vous référer au tableau ci-dessous pour les conditions de coupe en du tréflage.

Profondeur de coupe radiale	≤ 0.4DC
Engagement	≤ 0.5DC

Matière	No.	Dureté	φ 16, 17		φ 20, 21		φ 25, 26		φ 32, 33, 35		φ 40		φ 50	
			fr (mm/tour)	Etape (mm)	fr (mm/tour)	Etape (mm)	fr (mm/tour)	Etape (mm)	fr (mm/tour)	Etape (mm)	fr (mm/tour)	Etape (mm)	fr (mm/tour)	Etape (mm)
P Acier doux	1	≤180HB	0.035	0.2	0.045	0.3	0.05	0.3	0.055	0.3	0.06	0.3	0.065	0.3
	2	180–350HB	0.03	0.2	0.04	0.3	0.045	0.3	0.05	0.3	0.055	0.3	0.06	0.3
M Acier inoxydable	1,2,3,4	—	0.03	0.15	0.04	0.25	0.045	0.25	0.05	0.25	0.055	0.25	0.06	0.25
K Fonte	1	≤350MPa	0.04	0.4	0.05	0.5	0.06	0.5	0.065	0.5	0.07	0.5	0.075	0.5
N Alliage aluminium	1,2,3	—	0.04	0.2	0.05	0.3	0.06	0.3	0.065	0.3	0.07	0.3	0.075	0.3
H Acier traité	1	40–55HRC	0.02	0.15	0.03	0.25	0.035	0.25	0.04	0.25	0.045	0.25	0.05	0.25

Remarque 1) Le rainurage hélicoïdal est fortement recommandé pour l'usinage des aciers trempés.

Remarque 2) Lors de l'usinage avec le brise-copeaux G1 (VP15TF), réduire la vitesse de 20%.

Remarque 3) Pour les vitesses de coupe, cf. page K175.

■ POUR LES OPÉRATIONS DE RAMPING

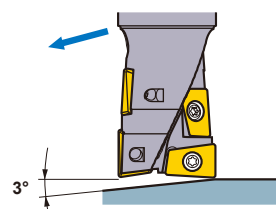

- Pour l'usinage de l'acier, l'angle de ramping maximal recommandé est de 3°. Si l'angle de ramping est supérieur à 3°, il se peut que les copeaux ne se brisent pas correctement et s'accumulent autour de l'outil.
- En ramping, il est recommandé de réduire la vitesse d'avance de 40 %.

FRAISES À PLAQUETTES

FRAISES MULTI FONCTIONS



AJX



K

FRAISES À PLAQUETTES



Fig.1

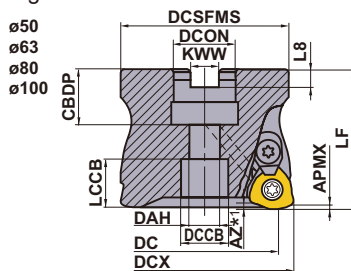
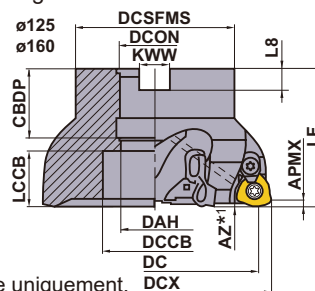

Fig.2



Porte-outil à droite uniquement.

(mm)

DCX	Vis d'attachement	Géométrie
DCON Taille mm		
φ50, φ52, φ63, φ66	HSC10030H	① ②
φ80	HSC12035H	
φ100	HSC16040H	
φ125, φ160	MBA20040H	

ATTACHEMENT PAR ALÉSAGE

AJX09 GAMP : +8° GAMF : -6°	AJX12 GAMP : +8° GAMF : -5° - 4°	AJX14 GAMP : +8° GAMF : -5° - 3°
--	---	---

Avec trou de lubrification

DCX (mm)	Référence	Stock R	Nombre de dents	Dimensions (mm)			WT*2 (kg)	APMX (mm)	RMPX	Fig.	Type Plaquette
				DC	LF	DCON					
50	AJX12-050A03R	●	3	38.3	50	22	0.4	1.2	2°	1	JDM1204
50	AJX12-050A04R	●	4	38.3	50	22	0.4	1.2	2°	1	JDM1204
50	AJX09-050A05R	●	5	40	50	22	0.5	1.2	1.1°	1	JDM09T3
52	AJX12-052A03R	□	3	40.3	50	22	0.4	1.2	1.8°	1	JDM1204
52	AJX12-052A04R	●	4	40.3	50	22	0.4	1.2	1.8°	1	JDM1204
52	AJX09-052A05R	●	5	42	50	22	0.4	1.2	1.1°	1	JDM09T3
63	AJX14-063A03R	★	3	51.1	50	22	0.7	1.2	2.8°	1	JDM1405
63	AJX14-063A04R	●	4	51.1	50	22	0.7	1.2	2.8°	1	JDM1405
63	AJX12-063A05R	●	5	51.3	50	22	0.9	1.2	1.5°	1	JDM1204
66	AJX14-066A03R	□	3	54.1	50	22	0.7	1.2	2.5°	1	JDM1405
66	AJX14-066A04R	●	4	54.1	50	22	0.7	1.2	2.5°	1	JDM1405
66	AJX12-066A05R	●	5	54.3	50	22	0.8	1.2	2.5°	1	JDM1204
80	AJX14-080A04R	★	4	68.1	50	27	1.2	1.2	1.8°	1	JDM1405
80	AJX14-080A05R	●	5	68.1	50	27	1.2	1.2	1.8°	1	JDM1405
80	AJX12-080A06R	●	6	68.3	50	27	1.2	1.2	1.1°	1	JDM1204
100	AJX14-100A05R	●	5	88.1	63	32	2.4	1.2	1.2°	1	JDM1405
100	AJX14-100A06R	●	6	88.1	63	32	2.4	1.2	1.2°	1	JDM1405
100	AJX12-100A07R	●	7	88.3	63	32	2.6	1.2	0.8°	1	JDM1204
125	AJX14-125B05R	★	5	113.2	63	40	3.3	1.2	0.8°	2	JDM1405
125	AJX14-125B07R	●	7	113.2	63	40	3.3	1.2	0.8°	2	JDM1405
160	AJX14-160B06R	★	6	148.2	63	40	5	1.2	0.5°	2	JDM1405
160	AJX14-160B08R	★	8	148.2	63	40	5	1.2	0.5°	2	JDM1405

*1 Cf. page K187 pour la profondeur de perçage max. (AZ).

*2 WT : poids du corps

Remarque 1) Cf. page K187, pour la profondeur de passe max. (APMX) et la profondeur de perçage max. (AZ).

● : Article stocké. ★ : Article standard Japon.

□ : Article non stocké - Fabrication sur commande uniquement.







DIMENSIONS DE MONTAGE

DCX (mm)	Référence	Dimensions (mm)								Fig.
		DCON	CBDP	DAH	DCCB	LCCB	DCSFMS	KWW	L8	
50	AJX12-050A03R	22	20	11	17	17.28	47	10.4	6.3	1
50	AJX12-050A04R	22	20	11	17	17.28	47	10.4	6.3	1
50	AJX09-050A05R	22	20	11	17	17.31	47	10.4	6.3	1
52	AJX12-052A03R	22	20	11	17	17.28	47	10.4	6.3	1
52	AJX12-052A04R	22	20	11	17	17.28	47	10.4	6.3	1
52	AJX09-052A05R	22	20	11	17	17.31	47	10.4	6.3	1
63	AJX14-063A03R	22	20	11	17	17.16	60	10.4	6.3	1
63	AJX14-063A04R	22	20	11	17	17.16	60	10.4	6.3	1
63	AJX12-063A05R	22	20	11	17	17.28	60	10.4	6.3	1
66	AJX14-066A03R	22	20	11	17	17.16	60	10.4	6.3	1
66	AJX14-066A04R	22	20	11	17	17.16	60	10.4	6.3	1
66	AJX12-066A05R	22	20	11	17	17.28	60	10.4	6.3	1
80	AJX14-080A04R	27	23	13	19	16.16	76	12.4	7	1
80	AJX14-080A05R	27	23	13	19	16.16	76	12.4	7	1
80	AJX12-080A06R	27	23	13	19	16.28	76	12.4	7	1
100	AJX14-100A05R	32	26	17	26	26.16	96	14.4	8	1
100	AJX14-100A06R	32	26	17	26	26.16	96	14.4	8	1
100	AJX12-100A07R	32	26	17	26	26.28	96	14.4	8	1
125	AJX14-125B05R	40	40	—	56	22.14	100	16.4	9	2
125	AJX14-125B07R	40	40	—	56	22.14	100	16.4	9	2
160	AJX14-160B06R	40	40	—	56	22.14	100	16.4	9	2
160	AJX14-160B08R	40	40	—	56	22.14	100	16.4	9	2

K

FRAISES À PLAQUETTES

PIÈCES DÉTACHÉES

Porte-outil Type	 *		 *		 T  D
	Vis de serrage	Bride de fixation	Vis de fixation	Ressort	Clé
AJX09	TS351	AMS3	AJS3010T10	ASS2	TKY10D
AJX12	TS43	AMS4	AJS4012T15	ASS2	TKY15T
AJX14	TS54	AMS5	AJS5014T25	ASS3	TKY25T

* Couple de serrage (N • m) : TS351=2,5, TS43=3,5, TS54=7,5, AJS3010T10=2,5, AJS4012T15=3,5, AJS5014T25=7,5

FRAISES À PLAQUETTES

K

FRAISES À PLAQUETTES

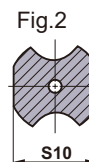
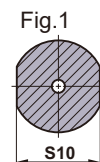
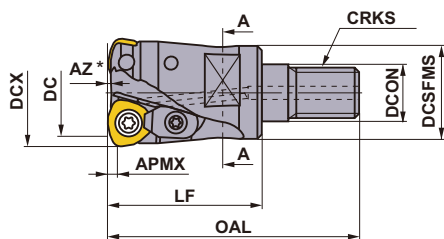

Section A-A

■ FRAISE À EMBOUT FILETÉ

Avec trou de lubrification

Outil à droite uniquement.

DCX (mm)	Référence	Stock		Dimensions (mm)								*2 WT (kg)	APMX (mm)	RMPX	Fig.	Attachement Cylindrique	Type Plaquette
		R	Nombre de dents	DC	LF	OAL	DCON	DCSFMS	S10	CRKS							
16	AJX06R162AM08	●	2	8.9	25	43	8.5	13	10	M8	0.1	0.6	3°	2	SC16M08	JOM06T2	
17	AJX06R172AM08	●	2	9.9	25	43	8.5	13	10	M8	0.1	0.6	2.5°	2	SC16M08	JOM06T2	
20	AJX08R202AM10	●	2	11.4	28	47	10.5	18	15	M10	0.1	0.9	3.5°	2	SC20M10	JOM0803	
20	AJX06R203AM10	●	3	12.9	28	47	10.5	18	15	M10	0.1	0.6	1.5°	3	SC20M10	JOM06T2	
22	AJX08R222AM10	●	2	13.4	28	47	10.5	18	15	M10	0.1	0.9	3°	2	SC20M10	JOM0803	
22	AJX06R223AM10	●	3	14.9	28	47	10.5	18	15	M10	0.1	0.6	1°	3	SC20M10	JOM06T2	
25	AJX09R252AM12	●	2	14.9	36	58	12.5	21	17	M12	0.2	1.2	4°	2	SC25M12	JDM09T3	
25	AJX08R253AM12	●	3	16.4	36	58	12.5	21	17	M12	0.1	0.9	2°	1	SC25M12	JOM0803	
28	AJX09R282AM12	●	2	17.9	36	58	12.5	21	17	M12	0.2	1.2	3°	2	SC25M12	JDM09T3	
28	AJX08R283AM12	●	3	19.4	36	58	12.5	21	17	M12	0.1	0.9	1.7°	1	SC25M12	JOM0803	
30	AJX12R302AM16	●	2	18.3	47	70	17	29	22	M16	0.3	1.2	4.5°	2	SC32M16	JDM1204	
30	AJX09R303AM16	●	3	20	47	70	17	29	22	M16	0.2	1.2	2.7°	1	SC32M16	JDM09T3	
32	AJX12R322AM16	●	2	20.3	47	70	17	29	22	M16	0.3	1.2	4°	2	SC32M16	JDM1204	
32	AJX09R323AM16	●	3	21.9	47	70	17	29	22	M16	0.2	1.2	2.5°	1	SC32M16	JDM09T3	
35	AJX12R352AM16	●	2	23.3	47	70	17	29	22	M16	0.3	1.2	3.5°	2	SC32M16	JDM1204	
35	AJX09R353AM16	●	3	24.9	47	70	17	29	22	M16	0.2	1.2	2°	1	SC32M16	JDM09T3	
40	AJX12R403AM16	●	3	28.3	60	83	17	29	22	M16	0.3	1.2	3°	2	SC32M16	JDM1204	
40	AJX09R404AM16	●	4	29.9	60	83	17	29	22	M16	0.2	1.2	1.5°	1	SC32M16	JDM09T3	

*1 Cf. page K187 pour la profondeur de perçage max. (AZ).

*2 WT : Poids de l'outil

Remarque 1) Cf. page K187, pour la profondeur de passe max. (APMX) et la profondeur de perçage max. (AZ).

Remarque 2) Pour les arbres vissables, veuillez vous référer à la page K244.

● : Article stocké. ★ : Article standard Japon.



Fig.1

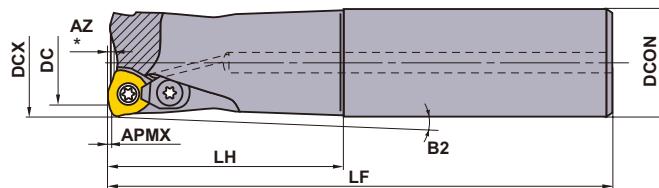
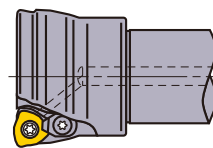

Fig.2



■ FRAISE À QUEUE CYLINDRIQUE

Outil à droite uniquement.

Avec trou de lubrification

DCX (mm)	Référence	Stock R	Nombre de dents	Dimensions (mm)				B2	APMX (mm)	RMPX	Fig.	Type Plaquette
				LF	DC	LH	DCON					
16	AJX06R162SA16ES	●	2	70	8.9	20	16	3.5°	0.6	3°	1	JOM06T2
16	AJX06R162SA16S	●	2	110	8.9	30	16	2.25°	0.6	3°	1	JOM06T2
16	AJX06R162SA16L	●	2	150	8.9	70	16	0.93°	0.6	3°	1	JOM06T2
16	AJX06R162SA16EL	★	2	200	8.9	100	16	0.64°	0.6	3°	1	JOM06T2
17	AJX06R172SA16ES	●	2	70	9.9	20	16	—	0.6	2.5°	1	JOM06T2
17	AJX06R172SA16S	●	2	110	9.9	20	16	—	0.6	2.5°	1	JOM06T2
17	AJX06R172SA16L	●	2	150	9.9	20	16	—	0.6	2.5°	1	JOM06T2
17	AJX06R172SA16EL	★	2	200	9.9	20	16	—	0.6	2.5°	1	JOM06T2
20	AJX08R202SA20S	●	2	130	11.4	50	20	1.34°	0.9	3.5°	1	JOM0803
20	AJX06R203SA20S	●	3	130	12.9	50	20	1.31°	0.6	1.5°	1	JOM06T2
20	AJX08R202SA20L	●	2	180	11.4	100	20	0.65°	0.9	3.5°	1	JOM0803
20	AJX06R203SA20L	●	3	180	12.9	100	20	0.64°	0.6	1.5°	1	JOM06T2
20	AJX08R202SA20EL	★	2	250	11.4	130	20	0.5°	0.9	3.5°	1	JOM0803
22	AJX08R222SA20S	●	2	130	13.4	30	20	—	0.9	3°	1	JOM0803
22	AJX06R223SA20S	●	3	130	14.9	30	20	—	0.6	1°	1	JOM06T2
22	AJX08R222SA20L	●	2	180	13.4	30	20	—	0.9	3°	1	JOM0803
22	AJX06R223SA20L	●	3	180	14.9	30	20	—	0.6	1°	1	JOM06T2
22	AJX08R222SA20EL	★	2	250	13.4	30	20	—	0.9	3°	1	JOM0803
25	AJX09R252SA25S	●	2	140	14.9	60	25	1.1°	1.2	4°	1	JDM09T3
25	AJX08R253SA25S	●	3	140	16.4	60	25	1.1°	0.9	2°	1	JOM0803
25	AJX09R252SA25L	●	2	200	14.9	120	25	0.54°	1.2	4°	1	JDM09T3
25	AJX08R253SA25L	●	3	200	16.4	120	25	0.54°	0.9	2°	1	JOM0803
25	AJX09R252SA25EL	★	2	300	14.9	180	25	0.36°	1.2	4°	1	JDM09T3
28	AJX09R282SA25S	●	2	140	17.9	40	25	—	1.2	3°	1	JDM09T3
28	AJX08R283SA25S	●	3	140	19.4	40	25	—	0.9	1.7°	1	JOM0803
28	AJX09R282SA25L	●	2	200	17.9	40	25	—	1.2	3°	1	JDM09T3
28	AJX08R283SA25L	●	3	200	19.4	40	25	—	0.9	1.7°	1	JOM0803
28	AJX09R282SA25EL	★	2	300	17.9	40	25	—	1.2	3°	1	JDM09T3
30	AJX12R302SA32S	●	2	150	18.3	70	32	1.82°	1.2	4.5°	1	JDM1204
30	AJX09R303SA32S	●	3	150	20	70	32	1.79°	1.2	2.7°	1	JDM09T3
30	AJX12R302SA32L	●	2	200	18.3	120	32	1.04°	1.2	4.5°	1	JDM1204
30	AJX09R303SA32L	●	3	200	20	120	32	1.03°	1.2	2.7°	1	JDM09T3
30	AJX12R302SA32EL	★	2	300	18.3	180	32	0.69°	1.2	4.5°	1	JDM1204
32	AJX12R322SA32S	●	2	150	20.3	70	32	0.96°	1.2	4°	1	JDM1204
32	AJX09R323SA32S	●	3	150	21.9	70	32	0.94°	1.2	2.5°	1	JDM09T3
32	AJX12R322SA32L	●	2	200	20.3	120	32	0.55°	1.2	4°	1	JDM1204
32	AJX09R323SA32L	●	3	200	21.9	120	32	0.54°	1.2	2.5°	1	JDM09T3
32	AJX12R322SA32EL	★	2	300	20.3	180	32	0.36°	1.2	4°	1	JDM1204
35	AJX12R352SA32S	●	2	150	23.3	50	32	—	1.2	3.5°	1	JDM1204
35	AJX09R353SA32S	●	3	150	24.9	50	32	—	1.2	2°	1	JDM09T3
35	AJX12R352SA32L	●	2	200	23.3	50	32	—	1.2	3.5°	1	JDM1204
35	AJX09R353SA32L	●	3	200	24.9	50	32	—	1.2	2°	1	JDM09T3
35	AJX12R352SA32EL	★	2	300	23.3	50	32	—	1.2	3.5°	1	JDM1204

* Cf. page K187 pour la profondeur de perçage max. (AZ).

Remarque 1) Cf. page K187, pour la profondeur de passe max. (APMX) et la profondeur de perçage max. (AZ).

RALLONGES > K244
 PIÈCES DÉTACHÉES > N001
 DONNÉES TECHNIQUES > P001

FRAISES À PLAQUETTES







K
FRAISES À PLAQUETTES

DCX (mm)	Référence	Stock		Dimensions (mm)				B2	APMX (mm)	RMPX	Fig.	Type Plaque
		R	Nombre de dents	LF	DC	LH	DCON					
40	AJX12R403SA32S	●	3	150	28.3	50	32	—	1.2	3°	1	JDM1204
40	AJX09R404SA32S	●	4	150	29.9	50	32	—	1.2	1.5°	1	JDM09T3
40	AJX12R403SA32L	●	3	250	28.3	50	32	—	1.2	3°	1	JDM1204
40	AJX09R404SA32L	●	4	250	29.9	50	32	—	1.2	1.5°	1	JDM09T3
40	AJX12R402SA32EL	★	2	350	28.3	50	32	—	1.2	3°	1	JDM1204
40	AJX12R403SA40S	●	3	150	28.3	70	40	0.35°	1.2	0.95°	1	JDM1204
40	AJX09R404SA40S	●	4	150	29.9	70	40	1.8°	1.2	1.8°	1	JDM09T3
40	AJX12R403SA40L	□	3	250	28.3	70	40	0.35°	1.2	0.95°	1	JDM1204
40	AJX09R404SA40L	□	4	250	29.9	70	40	0.43°	1.2	0.92°	1	JDM09T3
40	AJX12R402SA40EL	□	2	350	28.3	70	40	0.35°	1.2	0.95°	1	JDM1204
40	AJX12R403SA42S	★	3	150	28.3	70	42	1.79°	1.2	3°	1	JDM1204
40	AJX12R403SA42L	★	3	250	28.3	70	42	1.79°	1.2	3°	1	JDM1204
40	AJX12R402SA42EL	★	2	350	28.3	70	42	1.79°	1.2	3°	1	JDM1204
50	AJX14R503SA40S	●	3	150	38.2	50	40	—	1.2		1	JDM1405
50	AJX14R503SA40L	□	3	250	38.2	50	40	—	1.2		1	JDM1405
50	AJX14R503SA42S	★	3	150	38.2	50	42	—	1.2	4.2°	1	JDM1405
50	AJX14R503SA42L	★	3	250	38.1	50	42	—	1.2	4.2°	1	JDM1405
63	AJX14R634SA40S	□	4	150	51.1	50	40	—	1.2		2	JDM1405
63	AJX14R634SA40L	□	4	250	51.1	50	40	—	1.2		2	JDM1405
63	AJX14R634SA42S	★	4	150	51.1	50	42	—	1.2	2.8°	2	JDM1405
63	AJX14R634SA42L	★	4	250	51.1	50	42	—	1.2	2.8°	2	JDM1405

Remarque 1) Cf. page K187 pour la profondeur de perçage max. (AZ).

Remarque 2) Cf. page K187, pour la profondeur de passe max. (APMX) et la profondeur de perçage max. (AZ).

PIÈCES DÉTACHÉES







Porte-outil Type	 *		 *		 
	Vis de serrage	Bride de fixation	Vis de fixation	Ressort	Clé
AJX06R162	TS25	—	—	—	TKY08F
AJX06R172	TS25	—	—	—	TKY08F
AJX06R203	TS25	—	—	—	TKY08F
AJX06R223	TS25	—	—	—	TKY08F
AJX08R202	TS33	—	—	—	TKY08D
AJX08R222	TS33	—	—	—	TKY08D
AJX08R253	TS33	—	—	—	TKY08D
AJX08R283	TS33	—	—	—	TKY08D
AJX09R252	TS351	AMS3	AJS3010T10	ASS2	TKY10D
AJX09R282	TS351	AMS3	AJS3010T10	ASS2	TKY10D
AJX09R303	TS351	AMS3	AJS3010T10	ASS2	TKY10D
AJX09R323	TS351	AMS3	AJS3010T10	ASS2	TKY10D
AJX09R353	TS351	AMS3	AJS3010T10	ASS2	TKY10D
AJX09R404	TS351	AMS3	AJS3010T10	ASS2	TKY10D
AJX12R302	TS407	AMS4	AJS4012T15	ASS2	TKY15D
AJX12R322	TS43	AMS4	AJS4012T15	ASS2	TKY15D
AJX12R352	TS43	AMS4	AJS4012T15	ASS2	TKY15D
AJX12R402	TS43	AMS4	AJS4012T15	ASS2	TKY15D
AJX12R403	TS43	AMS4	AJS4012T15	ASS2	TKY15D
AJX14R503	TS54	AMS5	AJS5014T25	ASS3	TKY25D
AJX14R634	TS54	AMS5	AJS5014T25	ASS3	TKY25D

* Couple de serrage (N · m) : TS25=1,0, TS33=1,0, TS351=2,5, TS407=3,5, TS43=3,5, TS54=7,5, AJS3010T10=2,5, AJS4012T15=3,5, AJS5014T25=7,5

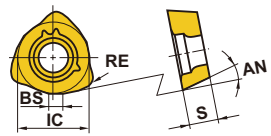
● : Article stocké. ★ : Article standard Japon.

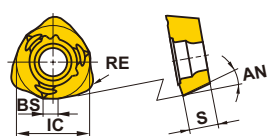
□ : Article non stocké - Fabrication sur commande uniquement. (10 plaquettes par boîte)

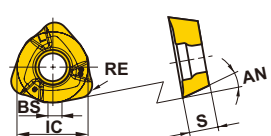
PLAQUETTES

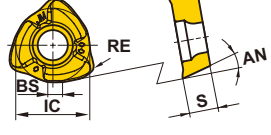
Matière	P	Acier	●	●	●											Conditions de coupe: ● : Coupe Stable ● : Coupe Générale ✦ : Coupe Instable		
	M	Acier Inoxydable				●	●											
	K	Fonte																
Forme	Référence	Classe	Revêtu								Dimensions (mm)				AN	Géométrie		
			FH7020	MP6120	MP6130	MP7130	MP7140	MP9120	MP9130	MP9140 <small>NEW</small>	VP15TF	VP30RT	IC	S			BS	RE
Profil partiel Brise-copeaux FT 	JOMW06T215ZZSR-FT	M	●	●	●	●	●	●	●	●	●	●	6.35	2.78	1.2	1.5	13°	
	JOMW080320ZZSR-FT	M	●	●	●	●	●	●	●	●	●	●	8	3.18	1.4	2	13°	
	JDMW09T320ZDSR-FT	M	●	●	●	●	●	●	●	●	●	●	9.525	3.97	1.8	2	15°	
	JDMW120420ZDSR-FT	M	●	●	●	●	●	●	●	●	●	●	12	4.76	2.5	2	15°	
	JDMW140520ZDSR-FT	M	●	●	●	●	●	●	●	●	●	●	14	5.56	2.8	2	15°	
Arête de coupe renforcée Brise-copeaux ST 	JDMT120420ZDSR-ST	M	●	●	●	●	●						12	4.76	2.5	2	15°	
	JDMT140520ZDSR-ST	M	●	●	●	●	●							14	5.56	2.8	2	
Concentration sur l'arête de coupe (Pour titane et réfractaires) Brise-copeaux JL 	JOMT06T216ZZER-JL	M				●	●	●	●	●	●		6.35	2.78	1.2	1.6	13°	
	JOMT080322ZZER-JL	M				●	●	●	●	●	●		8	3.18	1.4	2.2	13°	
	JDMT09T323ZDER-JL	M				●	●	●	●	●	●		9.525	3.97	1.8	2.3	15°	
	JDMT120423ZDER-JL	M				●	●	●	●	●	●		12	4.76	2.5	2.3	15°	
	JDMT140523ZDER-JL	M				●	●	●	●	●	●		14	5.56	2.8	2.3	15°	
Concentration sur l'arête de coupe (Pour coupe générale) Brise-copeaux JM 	JOMT06T215ZZSR-JM	M	●	●	●	●	●	●	●	●	●	●	6.35	2.78	1.2	1.5	13°	
	JOMT080320ZZSR-JM	M	●	●	●	●	●	●	●	●	●	●	8	3.18	1.4	2	13°	
	JDMT09T320ZDSR-JM	M	●	●	●	●	●	●	●	●	●	●	9.525	3.97	1.8	2	15°	
	JDMT120420ZDSR-JM	M	●	●	●	●	●	●	●	●	●	●	12	4.76	2.5	2	15°	
	JDMT140520ZDSR-JM	M	●	●	●	●	●	●	●	●	●	●	14	5.56	2.8	2	15°	

Remarque 1) La hauteur de plaquette est légèrement différente avec le brise-copeaux ST.
En cas d'utilisation du brise-copeaux ST, vérifier la hauteur de réglage.

● = NEW

K

FRAISES À PLAQUETTES

FRAISES À PLAQUETTES

CONDITIONS DE COUPE RECOMMANDÉES

VITESSE DE COUPE

Matière	Caratéristiques	Vitesse de coupe (m/min) pour les différentes nuances			
		FH7020	MP6120	MP6130	VP30RT
P					
Acier doux	Dureté ≤180HB	170 (120–220)	150 (100–200)	130 (80–180)	110 (60–160)
Acier carbone Acier allié	Dureté 180–280HB	150 (100–200)	130 (80–180)	110 (60–160)	90 (40–140)
Acier carbone Acier allié	Dureté 280–350HB	130 (80–180)	100 (50–150)	80 (30–130)	60 (20–110)
Acier outil	Dureté ≤350HB (Recuit)	130 (80–180)	100 (50–150)	80 (30–120)	60 (20–90)
Acier pré-traité	Dureté 35–45HRC	–	100 (70–130)	80 (50–110)	80 (30–90)
M					
Acier inoxydable	Dureté ≤270HB	140 (100–180)	120 (80–160)	–	–
K					
Fonte grise	Résistance à la traction ≤350MPa	150 (100–200)	–	–	–
Fonte ductile	Résistance à la traction ≤800MPa	–	120 (80–160)	–	–
S					
Alliage réfractaire	Dureté ≤350HB	30 (20–40)	25 (20–35)	20 (15–30)	–
Alliage titane	–	50 (40–60)	45 (30–55)	40 (30–50)	–
H					
Acier traité	Dureté 40–55HRC	70 (50–90)	–	–	–

K

FRAISES À PLAQUETTES

CAPACITÉS MAXIMALES SELON L'OPÉRATION

■ RAMPING

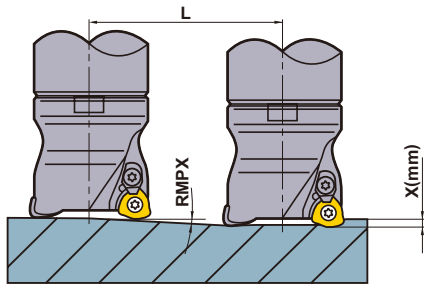

■ PERÇAGE HÉLICOÏDAL

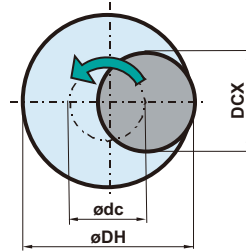

- Comment calculer l'interpolation hélicoïdale.

$$\text{ødc} = \text{øDH} - \text{DCX}$$

Diamètre d'interpolation Diamètre de trou désiré Diamètre de coupe max.

- Pour la profondeur de coupe par passe, consultez les conditions de coupe pour perçage hélicoïdal ci-dessus.
- Réglez la vitesse de l'axe de la machine de sorte que l'outil tourne et coupe en avalant.

- Au cours des opérations de ramping et de plongée, diminuer l'avance d'au moins 60% par rapport au taux calculé.
- En perçant, veuillez régler l'avance axiale de 0.2 mm/t ou moins.
- Les longs copeaux engendrés peuvent se disperser, assurez-vous que des mesures de sécurité adéquates sont prises.

Porte-outil Type	DCX (mm)	DC (mm)	APMX (mm)		RMPX	Ramping				Perçage hélicoïdal		AZ (mm)	
			FT/JM/ST Brise-copeaux	JL Brise-copeaux		L Distance requise pour X mm de profondeur (mm)				DH (mm)			
						X=1	X=1.2	X=1.5	X=2	Min	Max		
Attachement cylindrique / Fraise à embout fileté	AJX06	16	8.9	1	0.6	3°	19.1	—	—	—	23	29	0.3
	AJX06	17	9.9	1	0.6	2.5°	22.9	—	—	—	25	31	0.3
	AJX06	20	12.9	1	0.6	1.5°	38.2	—	—	—	31	37	0.3
	AJX06	22	14.9	1	0.6	1°	57.3	—	—	—	35	41	0.3
	AJX08	20	11.4	1.5	0.9	3.5°	16.3	19.6	24.5	—	27	36	0.5
	AJX08	22	13.4	1.5	0.9	3°	19.1	22.9	28.6	—	31	40	0.5
	AJX08	25	16.4	1.5	0.9	2°	28.6	34.4	43	—	37	46	0.5
	AJX08	28	19.4	1.5	0.9	1.7°	33.7	40.4	50.5	—	43	52	0.5
	AJX09	25	14.9	2	1.2	4°	14.3	17.2	21.5	28.6	33	46	1
	AJX09	28	17.9	2	1.2	3°	19.1	22.9	28.6	38.1	39	52	1
	AJX09	30	20	2	1.2	2.7°	21.2	25.4	31.8	42.4	43	56	1
	AJX09	32	21.9	2	1.2	2.5°	22.9	27.5	34.4	45.8	47	60	1
	AJX09	35	24.9	2	1.2	2°	28.6	34.4	43	57.3	53	66	1
	AJX09	40	29.9	2	1.2	1.5°	38.2	45.8	57.3	76.4	63	76	1
	AJX12	30	18.3	2	1.2	4.5°	12.7	15.2	19	25.4	39	56	1.5
	AJX12	32	20.3	2	1.2	4°	14.3	17.2	21.4	28.6	41	60	1.5
AJX12	35	23.3	2	1.2	3.5°	16.3	19.6	24.5	32.7	47	66	1.5	
AJX12	40	28.3	2	1.2	3°	19.1	22.9	28.6	38.2	57	76	1.5	
AJX14	50	38.2	2	1.2	4.2°	13.6	16.3	20.4	27.2	72	96	2	
AJX14	63	51.1	2	1.2	2.8°	20.4	24.5	30.7	40.9	98	122	2	
Attachement par alésage	AJX09	50	40	2	1.2	1.1°	52.1	62.5	78.1	104.2	83	96	1
	AJX12	50	38.3	2	1.2	2°	28.6	34.4	43	57.3	77	96	1.5
	AJX12	63	51.3	2	1.2	1.5°	38.2	45.8	57.3	76.4	103	122	1.5
	AJX12	80	68.3	2	1.2	1.1°	52.1	62.5	78.1	104.2	137	156	1.5
	AJX12	100	88.3	2	1.2	0.8°	71.6	85.9	107.4	143.2	177	196	1.5
	AJX14	63	51.1	2	1.2	2.8°	20.4	24.5	30.7	40.9	98	122	2
	AJX14	80	68.1	2	1.2	1.8°	31.8	38.2	47.7	63.6	132	156	2
	AJX14	100	88.1	2	1.2	1.2°	47.7	57.3	71.6	95.5	172	196	2
	AJX14	125	113.2	2	1.2	0.8°	71.6	85.9	107.4	143.2	222	246	2
AJX14	160	148.2	2	1.2	0.5°	114.6	137.5	171.9	229.2	292	316	2	

CONDITIONS DE COUPE RECOMMANDÉES

■ PROFONDEUR DE PASSE / AVANCE

Matière	Caratéristiques	Attachement cylindrique / Fraise à embout fileté										
		DCX=ø16, ø17			DCX=ø20, ø22			DCX=ø25, ø28				
		L	ap	fz (mm/dent)	L	ap	fz (mm/dent)	L	ap	fz (mm/dent)		
P	Acier doux	Dureté ≤180HB	140	0.8	0.8	160	1.0	1.0	170	1.0	1.2	
			180	0.6	0.6	210	0.8	0.8	230	0.8	1.0	
			210	0.4	0.4	240	0.6	0.6	290	0.6	0.8	
	Acier carbone Acier allié	Dureté 180–280HB	140	0.8	0.8	160	1.0	1.0	170	1.0	1.2	
			180	0.6	0.6	210	0.8	0.8	230	0.8	1.0	
			210	0.4	0.4	240	0.6	0.6	290	0.6	0.8	
	Acier carbone Acier allié	Dureté 280–350HB	140	0.7	0.8	160	0.8	1.0	170	0.8	1.2	
			180	0.5	0.6	210	0.6	0.8	230	0.6	1.0	
			210	0.3	0.4	240	0.4	0.6	290	0.4	0.8	
	Acier outil	Dureté ≤350HB	140	0.7	0.8	160	0.8	1.0	170	0.8	1.2	
			180	0.5	0.6	210	0.6	0.8	230	0.6	1.0	
			210	0.3	0.4	240	0.4	0.6	290	0.4	0.8	
	Acier pré-traité	Dureté 35–45HRC	140	0.7	0.7	160	0.8	0.8	170	0.8	1.0	
			180	0.5	0.5	210	0.6	0.6	230	0.6	0.8	
			210	0.3	0.3	240	0.4	0.4	290	0.4	0.6	
	M	Acier inoxydable	Dureté ≤270HB	140	0.8	0.7	160	1.0	0.8	170	1.0	1.0
				180	0.6	0.5	210	0.8	0.6	230	0.8	0.8
				210	0.4	0.3	240	0.6	0.4	290	0.6	0.6
K	Fonte grise	Résistance à la traction ≤350MPa	140	0.8	1.0	160	1.0	1.2	170	1.0	1.4	
			180	0.6	0.8	210	0.8	1.0	230	0.8	1.2	
			210	0.4	0.6	240	0.6	0.8	290	0.6	1.0	
	Fonte ductile	Résistance à la traction ≤800MPa	140	0.7	0.8	160	0.8	1.0	170	0.8	1.2	
			180	0.5	0.6	210	0.6	0.8	230	0.6	1.0	
			210	0.3	0.4	240	0.4	0.6	290	0.4	0.8	
S	Alliage réfractaire	Dureté ≤350HB	140	0.6	0.6	160	0.8	0.6	170	1.0	0.6	
			180	0.4	0.4	210	0.6	0.4	230	0.8	0.4	
	Alliage titane	—	210	0.3	0.3	240	0.4	0.3	290	0.6	0.3	
H	Acier traité	Dureté 40–55HRC	140	0.5	0.5	160	0.5	0.6	170	0.5	0.8	
			180	0.4	0.3	210	0.4	0.4	230	0.4	0.6	
			210	0.3	0.2	240	0.3	0.2	290	0.3	0.4	

K
FRAISES À PLAQUETTES

① Porte-à-faux L

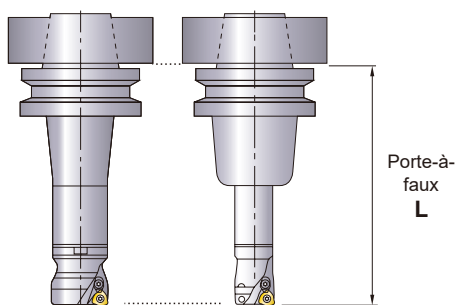

② Régime de la broche

$$n(\text{min}^{-1}) = (\text{Vitesse de coupe recommandée} \times 1000) \div (\text{DCX} \times 3.14)$$

③ Avance

$$V_f(\text{mm/min}) = n \times \text{Avance par dent} \times \text{Nombre de dents}$$

④ La largeur de coupe (ae) recommandée : plus de 60% du diamètre de la fraise (DCX).

⑤ Les conditions de coupe reportées ci-dessus se réfèrent à un porte-outil BT50.

Lors de l'usinage avec un attachement BT40 ou HSK63, il est recommandé d'usiner avec une fraise d'un diamètre inférieur à 35mm et de réduire l'avance table et la profondeur de coupe.

⑥ Il est recommandé d'utiliser un brise-copeaux ST avec une arête de coupe plus tenace pour la coupe interrompue. Quelle que soit la matière de la pièce à usiner, la nuance VP30RT est la plus adaptée pour les brise-copeaux ST non standard 06/08/09.

⑦ Lorsque le porte-à-faux est trop important et les conditions de coupe instables, il est recommandé de choisir une fraise série courte.

⑧ Utiliser un brise-copeaux JM pour de faibles efforts de coupe ou en cas d'un long porte-à-faux.

⑨ Les fraises à grande avance AJX produisent beaucoup de copeaux. En usinage, il est recommandé d'utiliser de l'air pulsé pour en faciliter l'évacuation et éviter le collage.

⑩ La profondeur de passe maximale du brise-copeaux JL diffère selon la taille de la plaquette.

La taille 06 va jusqu'à 0,6 mm, la taille 08 jusqu'à 0,9 mm et les tailles 09, 12, 14 jusqu'à 1,2 mm.

(mm)

	Attachement cylindrique / Fraise à embout fileté												Attachement par alésage					
	DCX=ø30, ø32, ø35			DCX=ø40 (ø32 Corps)			DCX=ø40 (ø42 Corps)			DCX=ø50, ø63			DCX=ø50, ø63			DCX=ø80, ø100, ø125, ø160		
	L	ap	fz (mm/dent)	L	ap	fz (mm/dent)	L	ap	fz (mm/dent)	L	ap	fz (mm/dent)	L	ap	fz (mm/dent)	L	ap	fz (mm/dent)
180	1.2	1.4	180	1.2	1.4	180	1.2	1.5	180	1.4	1.5	150	1.5	1.5	170	1.5	1.5	
230	1.0	1.2	240	1.0	1.2	240	1.0	1.3	240	1.2	1.3	250	1.3	1.3	300	1.3	1.3	
290	0.8	1.0	300	0.8	1.0	300	0.8	1.1	—	—	—	350	1.1	1.1	450	1.0	1.0	
180	1.2	1.4	180	1.2	1.4	180	1.2	1.5	180	1.4	1.5	150	1.5	1.5	170	1.5	1.5	
230	1.0	1.2	240	1.0	1.2	240	1.0	1.3	240	1.2	1.3	250	1.3	1.3	300	1.3	1.3	
290	0.8	1.0	300	0.8	1.0	300	0.8	1.1	—	—	—	350	1.1	1.1	450	1.0	1.0	
180	1.0	1.4	180	1.0	1.4	180	1.0	1.5	180	1.2	1.5	150	1.3	1.5	170	1.3	1.5	
230	0.8	1.2	240	0.8	1.2	240	0.8	1.3	240	1.0	1.3	250	1.1	1.3	300	1.1	1.3	
290	0.6	1.0	300	0.6	1.0	300	0.6	1.1	—	—	—	350	0.9	1.1	450	0.8	1.0	
180	1.0	1.4	180	1.0	1.4	180	1.0	1.5	180	1.2	1.5	150	1.3	1.5	170	1.3	1.5	
230	0.8	1.2	240	0.8	1.2	240	0.8	1.3	240	1.0	1.3	250	1.1	1.3	300	1.1	1.3	
290	0.6	1.0	300	0.6	1.0	300	0.6	1.1	—	—	—	350	0.9	1.1	450	0.8	1.0	
180	1.0	1.2	180	1.0	1.2	180	1.0	1.3	180	1.2	1.3	150	1.3	1.3	170	1.3	1.3	
230	0.8	1.0	240	0.8	1.0	240	0.8	1.1	240	1.0	1.1	250	1.1	1.1	300	1.1	1.1	
290	0.6	0.8	300	0.6	0.8	300	0.6	0.9	—	—	—	350	0.9	0.9	450	0.8	0.8	
180	1.2	1.2	180	1.2	1.2	180	1.2	1.3	180	*1.4	1.3	150	*1.5	1.3	170	*1.5	1.3	
230	1.0	1.0	240	1.0	1.0	240	1.0	1.1	240	1.2	1.1	250	*1.3	1.1	300	*1.3	1.1	
290	0.8	0.8	300	0.8	0.8	300	0.8	0.9	—	—	—	350	1.1	0.9	450	1.0	0.8	
180	1.2	1.6	180	1.2	1.6	180	1.2	1.7	180	1.4	1.7	150	1.5	1.7	170	1.5	1.7	
230	1.0	1.4	240	1.0	1.4	240	1.0	1.5	240	1.2	1.5	250	1.3	1.5	300	1.3	1.5	
290	0.8	1.2	300	0.8	1.2	300	0.8	1.3	—	—	—	350	1.1	1.3	450	1.0	1.2	
180	1.0	1.4	180	1.0	1.4	180	1.0	1.5	180	1.2	1.5	150	1.3	1.5	170	1.3	1.5	
230	0.8	1.2	240	0.8	1.2	240	0.8	1.3	240	1.0	1.3	250	1.1	1.3	300	1.1	1.3	
290	0.6	1.0	300	0.6	1.0	300	0.6	1.1	—	—	—	350	0.9	1.1	450	0.8	1.0	
180	1.2	0.6	180	1.2	0.6	180	1.2	0.6	180	1.2	0.6	150	1.2	0.6	170	1.2	0.6	
230	1.0	0.4	240	1.0	0.4	240	1.0	0.4	240	1.0	0.4	250	1.0	0.4	300	1.0	0.4	
290	0.8	0.3	300	0.8	0.3	300	0.8	0.3	—	—	—	350	0.8	0.3	450	0.8	0.3	
180	0.6	1.0	180	0.6	1.0	180	0.6	1.1	180	0.8	1.1	150	0.9	1.1	170	0.9	1.1	
230	0.5	0.8	240	0.5	0.8	240	0.5	0.9	240	0.6	0.9	250	0.7	0.9	300	0.7	0.9	
290	0.4	0.6	300	0.4	0.6	300	0.4	0.7	—	—	—	—	—	—	—	—	—	

* La profondeur de coupe maximale du brise-copeaux JL est de 1,2 mm.

NOTE POUR LA PROGRAMMATION

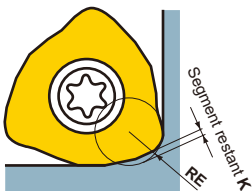

Programmer l'AJX avec le rayon de coupe.
Le rayon approximatif : RE, et le segment
restant : K, comme ci-dessous.

(mm)

Plaquette	Brise-copeaux	Approximatif RE	Segment restant K
06	FT / JM	2.0	0.33
	JL	2.5	0.32
08	FT / JM	2.5	0.46
	JL	2.0	0.40
09	FT / JM	3.0	0.47
	JL	3.0	0.46
12	FT / JM / ST	3.0	0.63
	JL	3.0	0.53
14	FT / JM / ST	3.0	0.64
	JL	3.0	0.55

Remarque 1) Le segment restant change légèrement en modifiant les conditions de coupe.

K

FRAISES À PLAQUETTES

FRAISES À PLAQUETTES

FRAISES MULTI FONCTIONS



BRP



K

FRAISES À PLAQUETTES

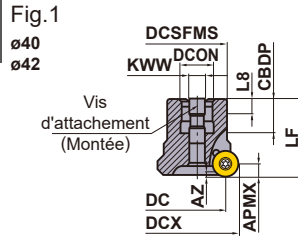

Fixer la vis d'attache.

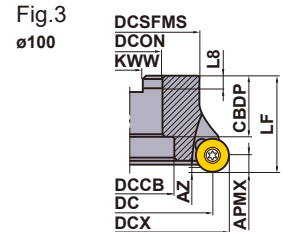
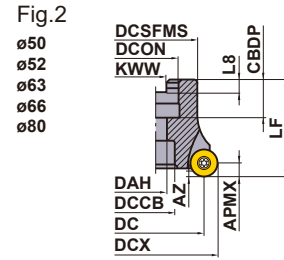

Porte-outil à droite uniquement.

ATTACHEMENT PAR ALÉSAGE

GAMP: +5°
GAMF: -4°-0°

Arête de coupe R (APMX)	Référence	Stock	Nombre de dents	Dimensions (mm)										*2 WT (kg)	Prof. de passe max. (mm)		*1	Clé	Vis d'attache	Type (Fig.)
				DCX	DC	DCSFMS	LF	DCON	CBDDP	DAH	KWW	L8	DCCB		APMX	AZ				
6	BRP6P-040A03R	★	3	40	27.9	30	40	16	18	-	8.4	5.6	-	0.4	6	4	TS43	TKY15D	HDS08030	1
	BRP6P-050A04R	★	4	50	37.8	41	50	22	20	11	10.4	6.3	-	0.5	6	4	TS43	TKY15D	-	2
	BRP6P-063A05R	★	5	63	50.8	42	50	22	20	11	10.4	6.3	-	0.7	6	4	TS43	TKY15D	-	2
	BRP6N-042A04R	●	4	42	29.8	30	40	16	18	-	8.4	5.6	-	0.4	6	4	TS43	TKY15D	HDS08030	1
	BRP6N-050A04R	●	4	50	37.8	41	50	22	20	11	10.4	6.3	-	0.5	6	4	TS43	TKY15D	-	2
	BRP6N-052A05R	●	5	52	39.8	41	63	22	20	11	10.4	6.3	-	0.5	6	4	TS43	TKY15D	-	2
	BRP6N-063A05R	●	5	63	50.8	42	50	22	20	11	10.4	6.3	-	0.7	6	4	TS43	TKY15D	-	2
	BRP6N-066A06R	●	6	66	53.8	42	63	22	20	11	10.4	6.3	-	0.7	6	4	TS43	TKY15D	-	2
8	BRP8P-063A04R	★	4	63	46.8	42	50	22	20	11	10.4	6.3	-	0.7	8	5.5	TS54	TKY25D	-	2
	BRP8N-063A04R	●	4	63	46.8	42	50	22	20	11	10.4	6.3	-	0.7	8	5.5	TS54	TKY25D	-	2
	BRP8N-080A06R	●	6	80	63.8	60	50	27	22	13	12.4	8	-	1.2	8	5.5	TS54	TKY25D	-	2
	BRP8N-100B07R	●	7	100	83.8	70	50	32	32	-	14.4	8	45	1.6	8	5.5	TS54	TKY25D	-	3

*1 Couple de serrage (N · m) : TS43=3,5, TS54=7,5

*2 WT : Poids de l'outil

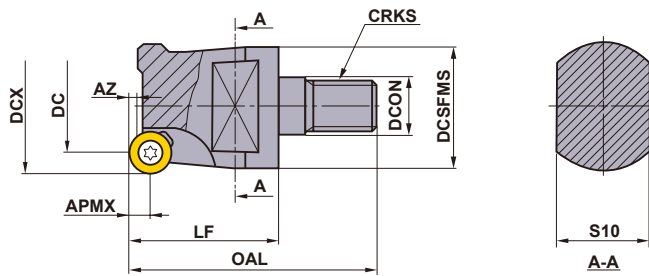

Outil à droite uniquement.

FRAISE À EMBOUT FILETÉ

Type	Référence	Stock	Nombre de dents	Dimensions (mm)										*1	Clé	Plaquette
				DCX	DC	OAL	LF	DCON	DCSFMS	S10	CRKS	APMX	AZ			
BRP4	BRP4NR161M08	●	1	16	7.8	46	28	8.5	13	10	M8	4	1	CS250560T	TKY08F	①RPMW08T2M0E/T ②RPMT08T2M0E-JS
	BRP4NR202M10	●	2	20	11.8	47	28	10.5	18	15	M10	4	2			
	BRP4NR253M12	●	3	25	16.8	54	32	12.5	21	17	M12	4	2			
	BRP4NR323M16	●	3	32	23.8	59	36	17	29	22	M16	4	2			
BRP5	BRP5NR201M10	●	1	20	9.8	51	32	10.5	18	15	M10	5	1.2	CS350760T	TKY15F	①RPMW10T3M0E/T ②RPMT10T3M0E-JS
	BRP5NR252M12	●	2	25	14.8	54	32	12.5	21	17	M12	5	2.5			
	BRP5NR323M12	●	3	32	21.8	58	36	17	29	22	M16	5	2.5			
	BRP5NR323M16	●	3	32	21.8	59	36	17	29	22	M16	5	2.5			
BRP6	BRP6NR322M16	●	2	32	19.8	58	35	17	29	22	M16	6	4	TS43	TKY15F	①RPMW1204M0E/T ②RPMW1204M0E-JS
	BRP6NR403M16	●	3	40	27.8	66	43	17	29	22	M16	6	4			
	BRP6NR424M16	●	4	42	29.8	66	43	17	29	22	M16	6	4			

Remarque 1) Pour les arbres vissables, veuillez vous référer à la page K244.

* Couple de serrage (N · m) : CS250560T=1,0, CS350760T=3,5, CS350860T=3,5, TS43=3,5

● : Article stocké. ★ : Article standard Japon.

□ : Article non stocké - Fabrication sur commande uniquement. (10 plaquettes par boîte)

PLAQUETTES

Matière	P	Acier	●	●	●	●	●	●	●	Conditions de coupe (Guide) : ● : Coupe Stable ● : Coupe Générale ✖ : Coupe Instable Honing : E : Ronde T : Chanfrein	
	M	Acier Inoxydable	●	●	●	●	●	●	●		
Forme	K	Fonte	●	●	●	●	●	●	●	Dimensions (mm) IC S Géométrie	
	S	Alliage réfractaire, Alliage titane	●	●	●	●	●	●	●		
Référence	H	Matériaux durs	●	●	●	●	●	●	●	Revêtu Cermet Carbure F7010 F7030 VP15TF AP20M NX2525 NX4545 UTi20T	
	Classe	Honing	Revêtu		Cermet		Carbure		Dimensions (mm)		
	RPMW08T2M0E	M	E						8	2.78	
	RPMW08T2M0T	M	T		●				8	2.78	
	RPMW10T3M0E	M	E	★				★	10	3.97	
	RPMW10T3M0T	M	T		●				10	3.97	
	RPMW1204M0E	M	E		●	●	□	●	12	4.76	
	RPMW1204M0T	M	T		●	●	□	●	12	4.76	
	RPMW1606M0E	M	E		●	●	□	●	16	6.35	
	RPMW1606M0T	M	T		●	●	□	●	16	6.35	
	RPMT08T2M0E-JS	M	E		●	●		●	8	2.78	
	RPMT10T3M0E-JS	M	E		●	●		●	10	3.97	
	RPMT1204M0E-JS	M	E	●	●	●	●	●	12	4.76	
	RPMT1606M0E-JS	M	E	●	●	●	●	●	16	6.35	

K
FRAISES À PLAQUETTES

CONDITIONS DE COUPE RECOMMANDÉES

■ VITESSE DE COUPE (m/min)

Matière	Dureté	Revêtu		Carbure	
		F7030	VP15TF	UTi20T	
P	Acier doux	≤180HB	250 (200–300)	250 (200–300)	150 (100–200)
	Acier carbone Acier allié	180–280HB	180 (130–220)	180 (130–220)	140 (100–170)
		280–380HB	160 (110–190)	160 (110–190)	100 (70–120)
	Acier pré-traité	35–45HRC	120 (80–140)	120 (80–140)	90 (60–100)
Acier hautement allié	300HB	130 (90–160)	130 (90–160)	100 (70–120)	
M	Acier inoxydable	≤260HB	180 (130–220)	180 (130–220)	140 (100–170)
K	Fonte	Résistance traction ≤350MPa	–	170 (130–220)	140 (100–170)
	Fonte ductile	Résistance traction 360–500MPa	–	140 (100–180)	120 (80–140)
		Résistance traction 500–800MPa	–	110 (80–140)	90 (70–110)
H	Acier traité	45–60HRC	–	60 (50–100)	60 (40–70)

Remarque 1) Les conditions de coupe indiquées en gras sont les premières recommandations.

■ AVANCE PAR DENT (mm/dent)

Type	Profondeur de passe (mm)							
	1	2	3	4	5	6	7	8
BRP4	0.40	0.30	0.20	0.10	–	–	–	–
BRP5	0.40	0.35	0.30	0.20	0.10	–	–	–
BRP6	0.50	0.40	0.30	0.25	0.23	0.20	–	–
BRP8	0.60	0.50	0.45	0.40	0.33	0.30	0.25	0.20

RALLONGES > K244
 PIÈCES DÉTACHÉES > N001
 DONNÉES TECHNIQUES > P001

FRAISES À PLAQUETTES

FRAISES À SURFACER-DRESSER

<ALLIAGE TITANE ET MATERIAUX DIFFICILES A USINER>

90°
KAPR

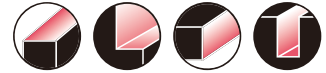

VFX5

P

M

K

N

S

H

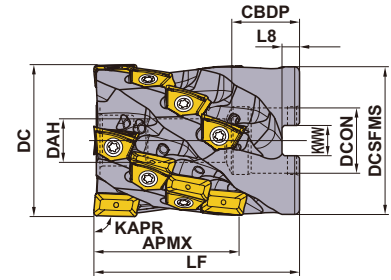

Outil à droite uniquement.

K

FRAISES À PLAQUETTES

■ FRAISE à ALÉSAGE

KAPR :90°

Référence	Stock		Total	Dimensions (mm)								APMX (mm)	WT* (kg)
	R	Nbre goujures		DC	LF	DCON	CBDP	DAH	DCSFMS	KWW	L8		
VFX5-040A03A026R	●	3	6	40	50	16	21	8.5	38.2	8.4	5.6	26	0.3
VFX5-040A03A038R	●	3	9	40	60	16	21	8.5	38.2	8.4	5.6	38	0.4
VFX5-050X03A026R	●	3	6	50	50	27	23	12.5	48.2	12.4	7.0	26	0.4
VFX5-050X03A038R	●	3	9	50	60	27	23	12.5	48.2	12.4	7.0	38	0.5
VFX5-050A04A026R	●	4	8	50	50	22	21	10.5	48.2	10.4	6.3	26	0.5
VFX5-050A04A038R	●	4	12	50	60	22	21	10.5	48.2	10.4	6.3	38	0.6
VFX5-050X04A038R	●	4	12	50	60	27	23	12.5	48.2	12.4	7.0	38	0.5
VFX5-050A04A050R	●	4	16	50	70	22	21	10.5	48.2	10.4	6.3	50	0.7
VFX5-063A05A026R	●	5	10	63	60	27	28	12.5	61	12.4	7.0	26	1.0
VFX5-063A05A063R	●	5	25	63	85	27	28	12.5	61	12.4	7.0	63	1.4
VFX5-080A06A075R	●	6	36	80	100	32	28	16.5	77.3	14.4	8.0	75	2.8

* WT : Poids de l'outil

● : Article stocké.

PIÈCES DÉTACHÉES

Référence	*2		Rondelle d'étanchéité	Clé	*3		Antigrippant	Vis d'attachement	Nombre de dents	
	Vis de serrage	Qté			Buse de liquide réfrigérant	Qté			Coupe en bout	Arête de coupe*1
VFX5-040A03A026R	TS352	6	W8-S1	TKY10D	HSD04004H08	9	MK1KS	HSC08040	3	3
VFX5-040A03A038R	TS352	9	W8-S1	TKY10D	HSD04004H08	12	MK1KS	HSC08050	3	6
VFX5-050X03A026R	TS352	6	W12-S1	TKY10D	HSD04004H08	9	MK1KS	HSC12035	3	3
VFX5-050X03A038R	TS352	9	W12-S1	TKY10D	HSD04004H08	12	MK1KS	HSC12045	3	6
VFX5-050A04A026R	TS352	8	W10-S1	TKY10D	HSD04004H08	12	MK1KS	HSC10035	4	4
VFX5-050A04A038R	TS352	12	W10-S1	TKY10D	HSD04004H08	16	MK1KS	HSC10045	4	8
VFX5-050X04A038R	TS352	12	W12-S1	TKY10D	HSD04004H08	16	MK1KS	HSC12045	4	8
VFX5-050A04A050R	TS352	16	W10-S1	TKY10D	HSD04004H08	20	MK1KS	HSC10055	4	12
VFX5-063A05A026R	TS352	10	W12-S1	TKY10D	HSD04004H08	15	MK1KS	HSC12045	5	5
VFX5-063A05A063R	TS352	25	W12-S1	TKY10D	HSD04004H08	30	MK1KS	HSC12070	5	20
VFX5-080A06A075R	TS352	36	W16-S1	TKY10D	HSD04004H08	42	MK1KS	HSC16080	6	30

*1 Sauf pour les plaquettes en bout, seul le rayon R0,8 peut être utilisé pour les plaquettes latérales.

*2 Couple de serrage (N • m) : TS352=2,5

*3 Les buses d'arrosage sont disponibles en différents diamètres selon la pression d'arrosage disponible.

	≤1Mpa (≤20 l/min.)	←Standard→	≥5Mpa (≥30 l/min.)	≥7Mpa (≥50 l/min.)
Diam.de buse	ø0.6mm	ø0.8mm	ø1.2mm	ø1.6mm
Référence	HSD04004H06	HSD04004H08	HSD04004H12	HSD04004H16

* Couple de serrage (N • m) : HSD0400H○=1,5

*4 Le numéro de référence de la buse d'arrosage brute, sans orifice est le HSS04004.

*5 À noter que pour les plaquettes de rayon 3,2 et au-delà, la dimension LF augmente proportionnellement .





Rayon de pointe 3,2 : LF+0,7 mm Rayon de pointe 4,0 : LF+1,5 mm

K

FRAISES À PLAQUETTES

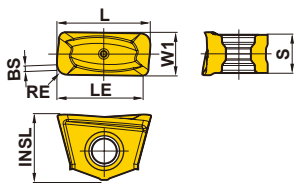
FRAISES À PLAQUETTES

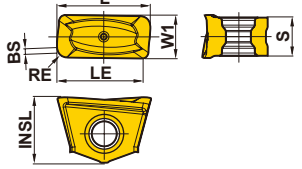
PLAQUETTES

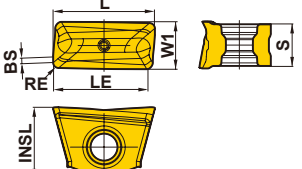
Matière	S	Alliage réfractaire, Alliage titane	✦	Conditions de coupe (Guide) :								Géométrie
	● : Coupe Stable ● : Coupe Générale ✦ : Coupe Instable											
Forme	Référence	Stock		Dimensions (mm)							Géométrie	
		MP9130	Revêtu	L	LE	W1	INSL	S	BS	RE		
Usage général 	XNMU160708R-MS	●		16.0	13.4	7.0	11.1	6.5	1.0	0.8		
	XNMU160712R-MS	●		16.0	13.8	7.0	11.1	6.5	1.0	1.2		
	XNMU160716R-MS	●		16.0	13.8	7.0	11.1	6.5	1.0	1.6		
	XNMU160724R-MS	●		16.0	13.8	7.0	11.1	6.5	1.0	2.4		
	*1 XNMU160732R-MS	●		17.3	14.4	7.0	11.1	6.5	—	3.2		
	*1 XNMU160740R-MS	●		18.9	15.2	7.0	11.1	6.5	—	4.0		
Arête de coupe renforcée 	XNMU160708R-HS	●		16.0	13.4	7.0	11.1	6.5	1.0	0.8		
Acuité améliorée 	XNMU160708R-LS	●		16.0	13.4	7.0	11.1	6.5	1.0	0.8		

*1 À noter que pour les plaquettes de rayon de pointe 3,2 et au-delà, la dimension LF augmente proportionnellement .
 Rayon de pointe 3,2 : LF+0,7 mm Rayon de pointe 4,0 : LF+1,5 mm

K

FRAISES À PLAQUETTES

● : Article stocké.

(10 plaquettes par boîte)

CONDITIONS DE COUPE RECOMMANDÉES

VFX5

Matière	Arête de coupe Diamètre (mm)	Nbre goujures	Plaquette recommandée	Vitesse de coupe Vc (m/min)	Régime n (min ⁻¹)	Profondeur de Passe APMX (mm)	Largeur de coupe ae (mm)	Avance par dent fz (mm/dent)	Avance table Vf (mm/min)	Débit de copeaux Q (cm ³ /min)	Puissance de broche estimée (kW)	Couple attendu (Nm)	Durée de vie relative (%)	
S Alliage titane (Ti-6Al-4V)	φ40	3	LS	40	318	38	40	0.10	95	145	6.5	194	40	
		3	MS	50	398	38	24	0.10	119	109	4.5	109	60	
		3	MS	60	477	38	16	0.10	143	87	3.5	69	80	
		3	HS	60	477	38	8	0.12	172	52	2.3	45	100	
	φ50	3	LS	40	255	38	50	0.10	76	145	6.5	242	40	
		4	MS	50	318	50	30	0.10	127	191	7.9	237	60	
		4	MS	60	382	50	20	0.10	153	153	6.0	151	80	
		4	HS	60	382	50	10	0.12	183	92	3.9	98	100	
	φ63	5	LS	40	202	60	63	0.10	101	382	16.8	793	40	
		5	MS	50	253	60	38	0.10	126	286	11.8	447	60	
		5	MS	60	303	60	25	0.10	152	229	9.0	285	80	
		5	HS	60	303	60	13	0.12	182	138	5.9	185	100	
	φ80	6	LS	40	159	75	80	0.10	95	573	25.0	1500	40	
		6	MS	50	199	75	48	0.10	119	430	17.6	846	60	
		6	MS	60	239	75	32	0.10	143	344	13.5	539	80	
		6	HS	60	239	75	16	0.12	172	206	8.7	350	100	
	Alliage titane (Ti-5Al-5V-5Mo-3Cr)	φ40	3	LS	25	199	38	40	0.08	48	73	3.4	161	30
			3	MS	25	199	38	24	0.08	48	44	1.9	92	50
			3	MS	30	239	38	16	0.10	72	44	1.8	74	70
			3	HS	30	239	38	8	0.10	72	22	1.0	41	90
φ50		4	LS	25	159	50	50	0.08	51	127	5.8	350	30	
		4	MS	25	159	50	30	0.08	51	76	3.4	201	50	
		4	MS	30	191	50	20	0.10	76	76	3.2	160	70	
		4	HS	30	191	50	10	0.10	76	38	1.8	89	90	
φ63		5	LS	25	126	60	63	0.08	51	191	8.7	658	30	
		5	MS	25	126	60	38	0.08	51	115	5.0	378	50	
		5	MS	30	152	60	25	0.10	76	115	4.8	301	70	
		5	HS	30	152	60	13	0.10	76	57	2.6	167	90	
φ80		6	LS	25	99	75	80	0.08	48	286	13.0	1246	30	
		6	MS	25	99	75	48	0.08	48	172	7.5	716	50	
		6	MS	30	119	75	32	0.10	72	172	7.1	570	70	
		6	HS	30	119	75	16	0.10	72	86	3.9	316	90	

Remarque 1) À noter que la performance d'usinage varie en fonction de conditions telles que la rigidité de la machine et de la fixation de la pièce, du système d'arrosage, de la pression et du débit, etc.

Remarque 2) Arrosage interne recommandé. Utilisez une rallonge de type FMH pour l'arrosage centre outil L'utilisation de liquide de coupe externe en association avec le liquide interne est encore plus efficace.

K

FRAISES À PLAQUETTES

FRAISES À PLAQUETTES

FRAISES À SURFACER-DRESSER

<ALLIAGE TITANE ET MATERIAUX DIFFICILES A USINER>

90°
KAPR

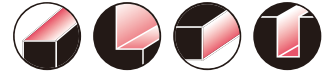

VFX6

P

M

K

N

S

H

K

FRAISES À PLAQUETTES

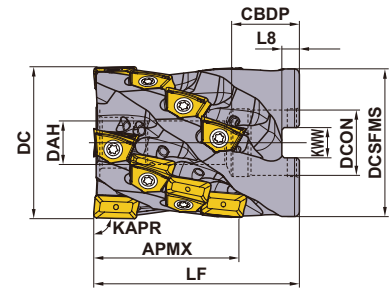

Outil à droite uniquement.

■ FRAISE à ALÉSAGE

KAPR : 90°

Référence	Stock R	Nbre goujures	Total	Dimensions (mm)								APMX (mm)	WT* (kg)
				DC	LF	DCON	CBDP	DAH	DCSFMS	KWW	L8		
VFX6-063A04A031R	●	4	8	63	60	27	28	12.5	61	12.4	7	31	0.9
VFX6-063A04A060R	●	4	16	63	85	27	28	12.5	61	12.4	7	60	1.3
VFX6-080A05A031R	●	5	10	80	60	32	28	16.5	77.3	14.4	8	31	1.5
VFX6-080A05A075R	●	5	25	80	100	32	28	16.5	77.3	14.4	8	75	2.6
VFX6-100A06A031R	●	6	12	100	65	40	30	20.5	96.6	16.4	9	31	2.7
VFX6-100A06A090R	●	6	36	100	115	40	30	20.5	96.6	16.4	9	90	4.8

* WT : Poids de l'outil

● : Article stocké.

PIÈCES DÉTACHÉES

Référence	*2		Rondelle d'étanchéité	Clé	*3		Antigrippant	Vis d'attachement	Nombre de dents	
	Vis de serrage	Qté			Buse de liquide réfrigérant	Qté			Coupe en bout	Arête de coupe*1 périphérique
VFX6-063A04A031R	TS450	8	W12-S1	TKY20T	HSD04004H08	12	MK1KS	HSC12045	4	4
VFX6-063A04A060R	TS450	16	W12-S1	TKY20T	HSD04004H08	20	MK1KS	HSC12070	4	12
VFX6-080A05A031R	TS450	10	W16-S1	TKY20T	HSD04004H08	15	MK1KS	HSC16040	5	5
VFX6-080A05A075R	TS450	25	W16-S1	TKY20T	HSD04004H08	30	MK1KS	HSC16080	5	20
VFX6-100A06A031R	TS450	12	W20-S1	TKY20T	HSD04004H08	18	MK1KS	HSC20040	6	6
VFX6-100A06A090R	TS450	36	W20-S1	TKY20T	HSD04004H08	42	MK1KS	HSC20090	6	30

*1 Sauf pour les plaquettes en bout, seul le rayon R1,2 peut être utilisé pour les plaquettes latérales.

*2 Couple de serrage (N • m) : TS450=5,0

*3 Buses d'arrosage disponibles en différents diamètres selon la pression d'arrosage disponible.

	≤1Mpa (≤20 l/min.)	←Standard→	≥5Mpa (≥30 l/min.)	≥7Mpa (≥50 l/min.)
Diam.de buse	ø0.6mm	ø0.8mm	ø1.2mm	ø1.6mm
Référence	HSD04004H06	HSD04004H08	HSD04004H12	HSD04004H16

* Couple de serrage (N • m) : HSD0400H○○=1,5

*4 Le numéro de référence de la buse d'arrosage brute, sans orifice est le HSS04004.

*5 À noter que pour les plaquettes de rayon 3,2 et au-delà, la dimension LF augmente proportionnellement .





Rayon de pointe 3,2 : LF+0,7 mm Rayon de pointe 4,0 : LF+1,5 mm Rayon de pointe 5,0 : LF+1,5 mm

K

FRAISES À PLAQUETTES

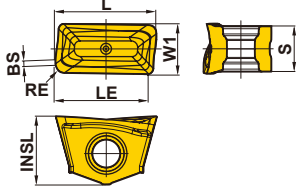
FRAISES À PLAQUETTES

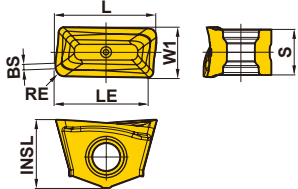
PLAQUETTES

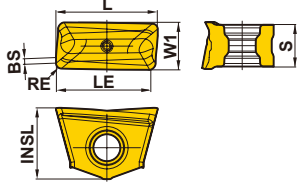
Matière	S	Alliage réfractaire, Alliage titane	✚	Conditions de coupe (Guide) :								Géométrie
	● : Coupe Stable ● : Coupe Générale ✚ : Coupe Instable											
Forme	Référence	Stock		Dimensions (mm)							Géométrie	
		MP9130	Revêtu	L	LE	W1	INSL	S	BS	RE		
Usage général 	XNMU190912R-MS	●		19.1	16.5	9.5	12.7	8.5	1.0	1.2		
	XNMU190916R-MS	●		19.1	16.5	9.5	12.7	8.5	1.0	1.6		
	XNMU190924R-MS	●		19.1	16.6	9.5	12.7	8.5	1.0	2.4		
	*1 XNMU190932R-MS	●		20.2	17.1	9.5	12.7	8.5	—	3.2		
	*1 XNMU190940R-MS	●		21.8	17.8	9.5	12.7	8.5	—	4.0		
	*1 XNMU190950R-MS	●		21.8	17.8	9.5	12.7	8.5	—	5.0		
Arête de coupe renforcée 	XNMU190912R-HS	●		19.1	16.5	9.5	12.7	8.5	1.0	1.2		
Acuité améliorée 	XNMU190912R-LS	●		19.1	16.5	9.5	12.7	8.5	1.0	1.2		

*1 À noter que pour les plaquettes de rayon de pointe 3,2 et au-delà, la dimension LF augmente proportionnellement .

Rayon de pointe 3,2 : LF+0,7 mm Rayon de pointe 4,0 : LF+1,5 mm Rayon de pointe 5,0 : LF+1,5 mm

K

FRAISES À PLAQUETTES

● : Article stocké.

(10 plaquettes par boîte)

CONDITIONS DE COUPE RECOMMANDÉES

■ VFX6

Matière	Arête de coupe Diamètre (mm)	Nbre goujures	Plaquette recommandée	Vitesse de coupe Vc (m/min)	Régime n (min ⁻¹)	Profondeur de Passe APMX (mm)	Largeur de coupe ae (mm)	Avance par dent fz (mm/dent)	Avance table Vf (mm/min)	Débit de copeaux Q (cm ³ /min)	Puissance de broche estimée (kW)	Couple attendu (Nm)	Durée de vie relative (%)	
S	Alliage titane (Ti-6Al-4V)	φ63	4	LS	40	202	60	63	0.10	81	306	13.4	634	40
			4	MS	50	253	60	38	0.10	101	229	9.5	357	60
			4	MS	60	303	60	25	0.10	121	183	7.2	228	80
			4	HS	60	303	60	13	0.12	146	110	4.7	148	100
	φ80	5	LS	40	159	75	80	0.10	80	477	20.8	1250	40	
		5	MS	50	199	75	48	0.10	99	358	14.7	705	60	
		5	MS	60	239	75	32	0.10	119	286	11.2	449	80	
		5	HS	60	239	75	16	0.12	143	172	7.3	291	100	
	φ100	6	LS	40	127	90	100	0.10	76	688	29.6	2218	40	
		6	MS	50	159	90	60	0.10	95	516	20.9	1252	60	
		6	MS	60	191	90	40	0.10	115	413	16.0	798	80	
		6	HS	60	191	90	20	0.12	138	248	10.3	517	100	
	Alliage titane (Ti-5Al-5V-5Mo-3Cr)	φ63	4	LS	25	126	60	63	0.08	40	153	7.0	527	30
			4	MS	25	126	60	38	0.08	40	92	4.0	303	50
			4	MS	30	152	60	25	0.10	61	92	3.8	241	70
			4	HS	30	152	60	13	0.10	61	46	2.1	133	80
φ80		5	LS	25	99	75	80	0.08	40	239	10.8	1038	30	
		5	MS	25	99	75	48	0.08	40	143	6.2	597	50	
		5	MS	30	119	75	32	0.10	60	143	5.9	475	70	
		5	HS	30	119	75	16	0.10	60	72	3.3	263	80	
φ100		6	LS	25	80	90	100	0.08	38	344	15.3	1841	30	
		6	MS	25	80	90	60	0.08	38	206	8.8	1059	50	
		6	MS	30	95	90	40	0.10	57	206	8.4	844	70	
		6	HS	30	95	90	20	0.10	57	103	4.7	466	80	

Remarque 1) À noter que la performance d'usinage varie en fonction de conditions telles que la rigidité de la machine et de la fixation de la pièce, du système d'arrosage, de la pression et du débit, etc.

Remarque 2) Arrosage interne recommandé. Utilisez une rallonge de type FMH pour l'arrosage centre outil L'utilisation de liquide de coupe externe en association avec le liquide interne est encore plus efficace.

K

FRAISES À PLAQUETTES

FRAISES À PLAQUETTES

FRAISES À SURFACER-DRESSER



DCCC

- P M K N S H

K

FRAISES À PLAQUETTES



■ CARACTÉRISTIQUES DE LA FRAISE DCCC

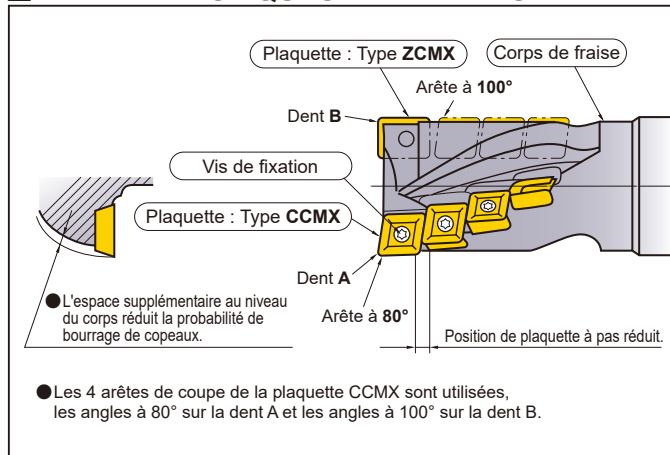

● Ø25 2 dent

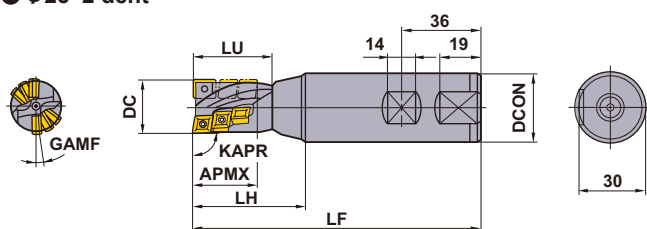

● Ø32 2 dent

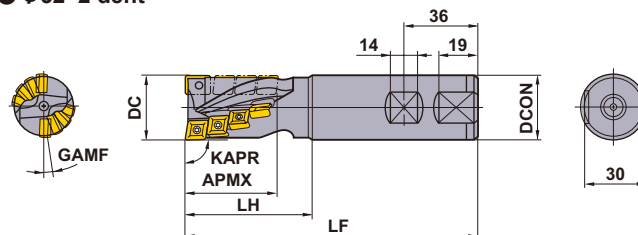

● Ø40 3 dent

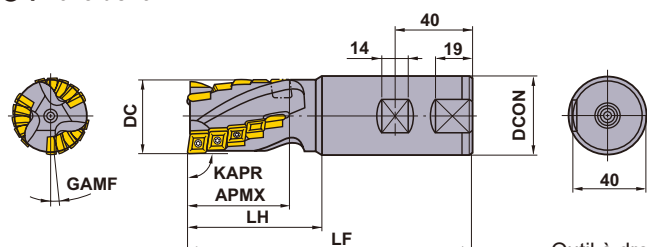

Outil à droite uniquement.

■ ATTACHEMENT WELDON

KAPR : 90°





DC (mm)	Référence	Stock	Dimensions (mm)					GAMF	WT* (kg)	Nombre de dents		Périphérie et bout		Bout uniquement	
			LF	DCON	LH	LU	APMX			En bout	Total	Type	Nombre de dents	Type	Nombre de dents
25	DCCCR2506S32	●	130	32	50	36	27	8°	0.6	2	6	CCMX08	5	ZCMX08	1
25	DCCCR2510S32	●	150	32	70	56	44	8°	0.7	2	10	CCMX08	9	ZCMX08	1
32	DCCCR3208S32	●	140	32	60	—	43	8°36'	0.8	2	8	CCMX09	7	ZCMX09	1
32	DCCCR3212S32	●	160	32	80	—	63	8°36'	0.8	2	12	CCMX09	11	ZCMX09	1
40	DCCCR4015S40	●	150	40	70	—	53	5°31'	1.3	3	15	CCMX09	14	ZCMX09	1
40	DCCCR4015S42	★	150	42	70	—	53	5°31'	1.3	3	15	CCMX09	14	ZCMX09	1
40	DCCCR4024S40	●	180	40	100	—	83	5°31'	1.4	3	24	CCMX09	23	ZCMX09	1
40	DCCCR4024S42	★	180	42	100	—	83	5°31'	1.4	3	24	CCMX09	23	ZCMX09	1

* WT : Poids de l'outil

● : Article stocké. ★ : Article standard Japon.

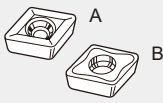





(10 plaquettes par boîte)

PIÈCES DÉTACHÉES

Référence porte-outil	*				
	 Vis de serrage	 Clé	 Clé	Plaquette	
DCCCR25	CS300890T	TKY08F	TKY08DS	CCMX083508EN-A	ZCMX083508ER-A
DCCCR32 DCCCR40	CS350990T	TKY10F	TKY10DS	CCMX09T308EN-A or B	ZCMX09T308ER-A or B

* Couple de serrage (N • m) : CS300890T=1,0, CS350990T=2,5

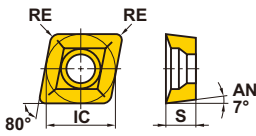
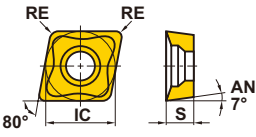
PLAQUETTES

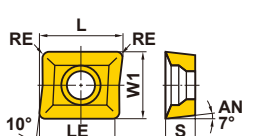
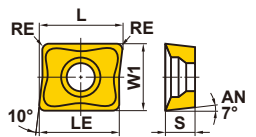
Matière	P	Acier					Conditions de coupe (Guide) :									
	M	Acier Inoxydable					●	●	✱							
	K	Fonte					Honing : E : Ronde									
Forme	Référence	Classe	Honing	Revêtu				Carbure		Dimensions (mm)						Géométrie
				F7030	VP15TF	UP20M	UT120T	L	LE	W1	IC	S	RE			
	CCMX083508EN-A	M	E	●	★	★			—	—	—	7.94	3.5	0.8		
	CCMX09T308EN-A	M	E	●	★	★			—	—	—	9.525	3.97	0.8		
Arête de coupe renforcée	CCMX09T308EN-B	M	E	●			★		—	—	—	9.525	3.97	0.8		
	ZCMX083508ER-A	M	E	●			★		11.0	8.5	7.94	—	3.5	0.8		
	ZCMX09T308ER-A	M	E	●	●	●	★		12.7	11.0	9.525	—	3.97	0.8		
Arête de coupe renforcée	ZCMX09T308ER-B	M	E	●	★				12.7	11.0	9.525	—	3.97	0.8		

CONDITIONS DE COUPE RECOMMANDÉES

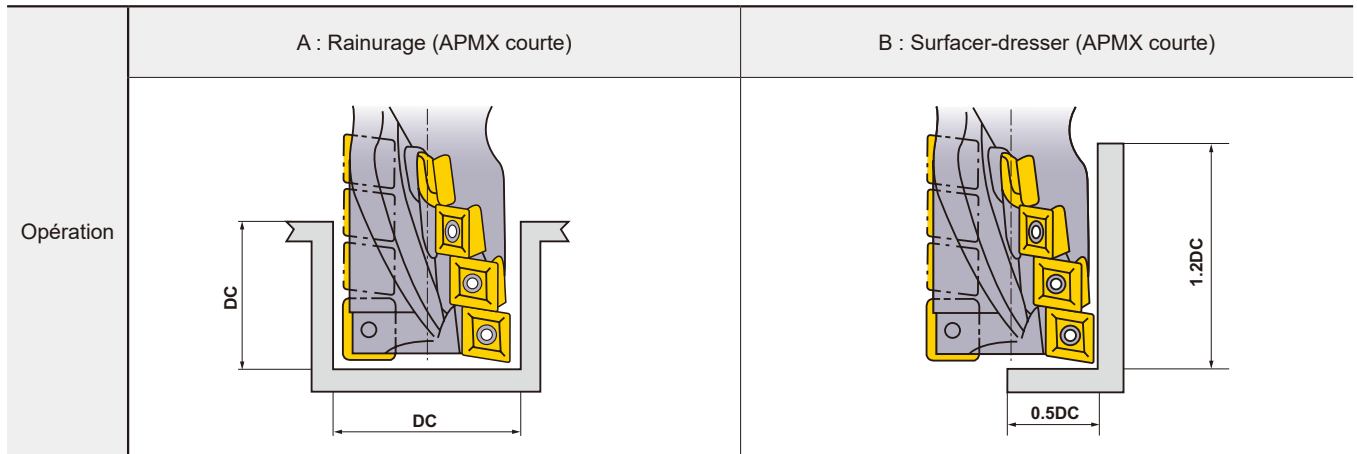

Matière	Dureté	Nuance	Opération	Vitesse de coupe (m/min)	Avance (mm/min)		
					φ25	φ32	φ40
P Acier doux	≤ 180HB	F7030	A	200 (160–240)	120 (100–140)	120 (100–140)	120 (100–140)
		F7030	B	200 (160–240)	200 (180–220)	200 (180–220)	230 (200–250)
	180–280HB	F7030	A	160 (130–180)	120 (100–140)	120 (100–140)	140 (120–150)
		F7030	B	160 (130–180)	150 (120–180)	150 (120–180)	180 (150–200)
Alliage acier 280–350HB	F7030	A	160 (130–180)	100 (80–120)	100 (80–120)	130 (100–150)	
	F7030	B	160 (130–180)	120 (100–140)	120 (100–140)	150 (120–180)	
M Acier inoxydable	≤ 200HB	F7030	A	80 (60–100)	70 (50–90)	70 (50–90)	70 (50–90)
		F7030	B	130 (100–160)	100 (80–120)	100 (80–120)	120 (100–140)
K Fonte	Résistance à la traction ≤ 450MPa	UT120T	A	120 (100–140)	200 (180–220)	200 (180–220)	230 (200–250)
		UT120T	B	120 (100–140)	230 (200–250)	230 (200–250)	260 (240–280)

● Régime (min^{-1}) = $(1000 \times \text{Vitesse de coupe}) \div (3.14 \times \text{DC})$

● Avance (mm/min) = Avance par dent × Nombre de dents × Régime de coupe

■ PUISSANCE ABSORBÉE

- Veuillez vous référer au tableau ci-dessous pour sélectionner les conditions adaptées à la puissance de la machine.
- Evacuation copeaux Q ($\text{mm}^3/\text{min}.$) = Avance x Profondeur de passe x Largeur de coupe ÷ 1000

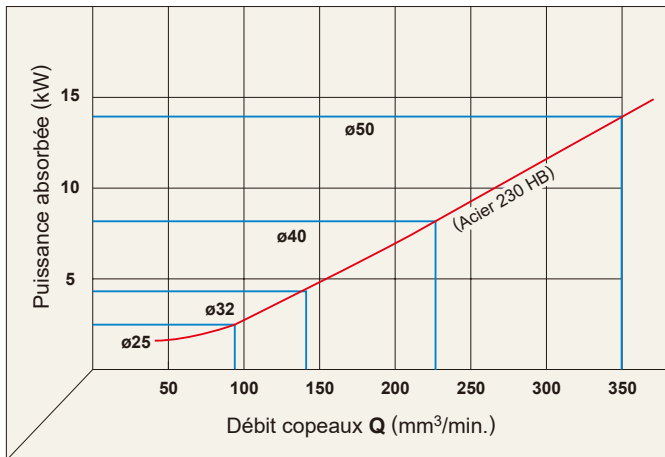

■ POUR GRANDE LONGUEUR DE COUPE APMX

- Comme le porte-à-faux de l'outil est long, une grande largeur de coupe causera un broutement et la rupture de l'outil.
- Maintenez une largeur de coupe faible et une grande profondeur de coupe axiale (voir l'illustration suivante).
- En rainurage, réglez l'avance table au maximum à la moitié de la valeur indiquée dans le tableau ci-dessus. (Utilisez l'APMX courte autant que possible.)

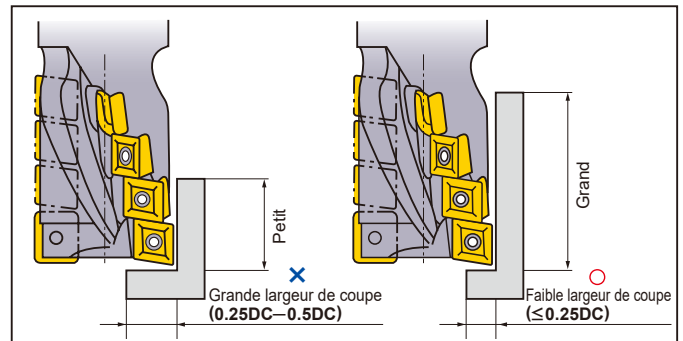

FRAISES À SURFACER-DRESSER



SPX

- P
- M
- K
- N
- S
- H



● Queue diamètre SK50

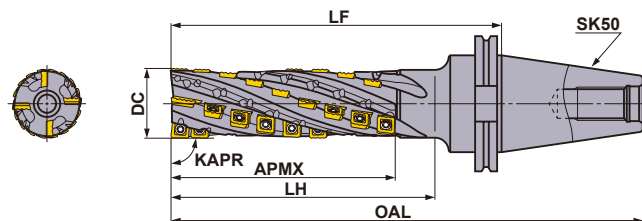

K

FRAISES À PLAQUETTES

KAPR :90°

Référence	Stock	Nombre de dents			Dimensions (mm)					Nombre de dents		
										En bout sur champ A	En bout sur champ B	En périphérie
		Dents	Total	En bout	DC	OAL	LH	LF	APMX	JPMX 190412-○○	MPMX 120412-○○	SPMX 120408-○○
SPX4R06324SK50NS	<input type="checkbox"/>	2	24	4	63	289.6	140	188	110	2	2	20
SPX4R06334SK50NM	<input type="checkbox"/>	2	34	4	63	339.6	190	238	157	2	2	30
SPX4R06344SK50NL	<input type="checkbox"/>	2	44	4	63	389.6	240	288	205	2	2	40
SPX4R06356SK50NX	<input type="checkbox"/>	2	56	4	63	439.6	290	338	261	2	2	52

: Article non stocké - Fabrication sur commande uniquement.

PIÈCES DÉTACHÉES > N001
DONNÉES TECHNIQUES > P001

K203

FRAISES À PLAQUETTES

K

FRAISES À PLAQUETTES

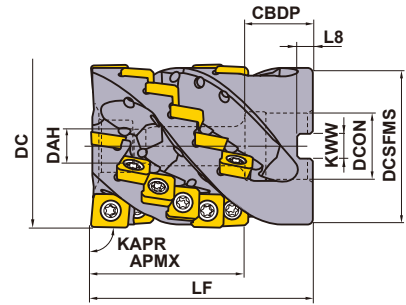
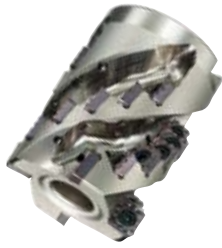

Outil à droite uniquement.

Diamètre fraise DC (mm)	Vis d'attachement	Géométrie
φ63	HSC12070	
φ80	HSC16065	

FRAISE à ALÉSAGE

KAPR :90°

Référence	Stock R	Nombre de dents		Dimensions (mm)									Nombre de dents		
													En bout sur champ A	En bout sur champ B	En périphérie
													JPMX 140412-∅	MPMX 120412-∅	SPMX 120408-∅
SPX4-063A24A058RA	●	4	24	63	85	27	28	13	60	12.4	7	58	2	2	20
SPX4-080A24A058RA	★	4	24	80	85	32	40	17	76.8	14.4	8	58	2	2	20

Remarque 1) En cas d'arrosage interne, utiliser un porte-fraise avant avec des canaux d'arrosage continus. Les mandrins ordinaires avec passage central ou latéral ne peuvent pas être utilisés.

PIÈCES DÉTACHÉES

Porte-outil Type	*			Plaquette		
				En bout sur champ A	En bout sur champ B	En périphérie
				JPMX140412-WH	MPMX120412-WH	SPMX120408-WH
SPX	TS55	TKY25D	MK1KS	JPMX140412-JM	MPMX120412-JM	SPMX120408-JM

* Couple de serrage (N • m) : TS55=7,5

● : Article stocké. ★ : Article standard Japon.
(10 plaquettes par boîte)

PLAQUETTES

Matière		P	Acier	●	●	Conditions de coupe (Guide): ● : Coupe Stable ● : Coupe Générale ✦ : Coupe Instable						
		M	Acier Inoxydable	●	●							
K	Fonte	✦	✦									
S	Alliage réfractaire, Alliage titane	●	✦									
Type	Forme	Référence	Classe	Revêtu		Dimensions (mm)						Géométrie
				VP15TF	VP20RT	L	LE	W1	IC	S	RE	
Arête de coupe ondulée (Brise-copeaux WH) En bout sur champ A		JPMX190412-WH	M	●	●	19.81	17.6	12.7	—	4.76	1.2	
		* JPMX140412-WH	M	●	●	15.04	12.9	12.7	—	4.76	1.2	
	En bout sur champ B		MPMX120412-WH	M	●	●	—	—	—	12.7	4.76	1.2
En périphérie			SPMX120408-WH	M	●	●	—	—	—	12.7	4.76	0.8
Arête de coupe droite (Brise-copeaux JM) En bout sur champ A		JPMX190412-JM	M	●	●	19.81	17.6	12.7	—	4.83	1.2	
		* JPMX140412-JM	M	●	●	15.04	12.9	12.7	—	4.79	1.2	
	En bout sur champ B		MPMX120412-JM	M	●	●	—	—	—	12.7	4.79	1.2
En périphérie			SPMX120408-JM	M	●	●	—	—	—	12.7	4.80	0.8

* A utiliser seulement pour les fraises à alésage.

K

FRAISES À PLAQUETTES

FRAISES À PLAQUETTES

CONDITIONS DE COUPE RECOMMANDÉES (ATTACHEMENT CYLINDRIQUE)

■ CONDITIONS DE COUPE POUR FRAISAGE D'ÉPAULEMENT

Matière	Dureté	Nuance Brise-copeaux	Vitesse de coupe Vc (m/min)	Largeur de coupe : ae (mm) Avance par dent : fz (mm/dent)								
				φ 50 (dernier chiffre du numéro de référence pour le corps de la fraise)			φ 63 (dernier chiffre du numéro de référence pour le corps de la fraise)					
				S (APMX≤110)	M (APMX=157)	L (APMX=205)	S (APMX=110)	M (APMX=157)	L (APMX=205)	X (APMX=261)		
P Acier doux	≤ 180HB	VP15TF	WH	120 (100-140)	≤10.0 0.15-0.25	≤5.0 0.15-0.25	≤2.5 0.10-0.20	≤12.5 0.15-0.25	≤10.0 0.15-0.25	≤5.0 0.15-0.25	≤2.5 0.10-0.20	
			JM	120 (100-140)	≤7.5 0.10-0.20	≤5.0 0.10-0.20	≤2.5 0.05-0.15	≤10.0 0.10-0.20	≤7.5 0.10-0.20	≤5.0 0.10-0.20	≤2.5 0.05-0.15	
	Acier carbone Alliage acier		180-350HB	WH	80 (70-120)	≤10.0 0.15-0.25	≤5.0 0.15-0.25	≤2.5 0.10-0.20	≤12.5 0.15-0.25	≤10.0 0.15-0.25	≤5.0 0.15-0.25	≤2.5 0.10-0.20
				JM	80 (70-120)	≤7.5 0.10-0.20	≤5.0 0.10-0.20	≤2.5 0.05-0.15	≤10.0 0.10-0.20	≤7.5 0.10-0.20	≤5.0 0.10-0.20	≤2.5 0.05-0.15
	Acier outil		≤ 300HB	WH	80 (60-100)	≤10.0 0.10-0.20	≤5.0 0.10-0.20	≤2.5 0.05-0.15	≤12.5 0.10-0.20	≤10.0 0.10-0.20	≤5.0 0.10-0.20	≤2.5 0.05-0.15
				JM	80 (60-100)	≤7.5 0.10-0.15	≤5.0 0.10-0.15	≤2.5 0.05-0.10	≤10.0 0.10-0.15	≤7.5 0.10-0.15	≤5.0 0.10-0.15	≤2.5 0.05-0.10
M Acier inoxydable	≤ 200HB	VP20RT	WH	80 (60-100)	≤7.5 0.08-0.15	≤5.0 0.08-0.15	≤2.5 0.05-0.10	≤10.0 0.08-0.15	≤7.5 0.08-0.15	≤5.0 0.08-0.15	≤2.5 0.05-0.10	
			JM	80 (60-100)	≤5.0 0.08-0.15	≤3.5 0.08-0.15	≤2.0 0.05-0.10	≤7.5 0.08-0.15	≤5.0 0.08-0.15	≤3.5 0.08-0.15	≤2.0 0.05-0.10	
K Fonte	Résistance à la traction ≤350MPa	VP15TF	WH	100 (80-120)	≤10.0 0.15-0.40	≤5.0 0.15-0.35	≤2.5 0.10-0.30	≤12.5 0.15-0.40	≤10.0 0.15-0.40	≤5.0 0.15-0.35	≤2.5 0.10-0.30	
			JM	100 (80-120)	≤7.5 0.10-0.25	≤5.0 0.10-0.25	≤2.5 0.05-0.20	≤10.0 0.10-0.25	≤7.5 0.10-0.25	≤5.0 0.10-0.25	≤2.5 0.05-0.20	
	Fonte ductile		Résistance à la traction ≤800MPa	WH	80 (60-100)	≤10.0 0.15-0.35	≤5.0 0.15-0.30	≤2.5 0.10-0.25	≤12.5 0.15-0.35	≤10.0 0.15-0.35	≤5.0 0.15-0.30	≤2.5 0.10-0.25
				JM	80 (60-100)	≤7.5 0.10-0.20	≤5.0 0.10-0.20	≤2.5 0.05-0.15	≤10.0 0.10-0.20	≤7.5 0.10-0.20	≤5.0 0.10-0.20	≤2.5 0.05-0.15
S Alliage titane	≤ 350HB	VP20RT	WH	40 (35-50)	≤5.0 0.05-0.10	≤3.5 0.05-0.10	≤2.0 0.05-0.10	≤7.5 0.05-0.10	≤5.0 0.05-0.10	≤3.5 0.05-0.10	≤2.0 0.05-0.10	
			JM	40 (35-50)	≤3.5 0.05-0.10	≤2.5 0.05-0.10	≤1.5 0.05-0.10	≤5.0 0.05-0.10	≤3.5 0.05-0.10	≤2.5 0.05-0.10	≤1.5 0.05-0.10	

Remarque 1) Les recommandations de données de coupe indiquées ci-dessus sont des valeurs générales initiales pour des machines et des pièces de grande rigidité. En cas de vibrations, veuillez adapter les données de coupe en conséquence.

Remarque 2) Lors d'un fraisage d'un angle supérieur à 90°, réduire Vc et Vf de 10/20% et ae de 50%.

Et si possible faire une deuxième passe avec un deuxième outil pour une bonne finition.

■ CONDITIONS DE COUPE POUR RAINURAGE

Matière	Dureté	Nuance Brise-copeaux	Vitesse de coupe Vc (m/min)	Profondeur de Passe : ap (mm) Avance par dent : fz (mm/dent)								
				φ 50 (dernier chiffre du numéro de référence pour le corps de la fraise)			φ 63 (dernier chiffre du numéro de référence pour le corps de la fraise)					
				S (APMX≤110)	M (APMX=157)	L (APMX=205)	S (APMX=110)	M (APMX=157)	L (APMX=205)	X (APMX=261)		
P Acier doux	≤ 180HB	VP15TF	WH	60 (50-120)	≤10.0 0.10-0.25	≤5.0 0.10-0.20	≤2.5 0.10-0.15	≤12.5 0.10-0.25	≤10.0 0.10-0.25	≤5.0 0.10-0.20	≤2.5 0.10-0.15	
			JM	60 (50-120)	≤7.5 0.10-0.15	≤5.0 0.10-0.15	≤2.5 0.10-0.15	≤10.0 0.10-0.15	≤7.5 0.10-0.15	≤5.0 0.10-0.15	≤2.5 0.10-0.15	
	Acier carbone Alliage acier		180-350HB	WH	60 (50-100)	≤10.0 0.10-0.25	≤5.0 0.10-0.20	≤2.5 0.10-0.15	≤12.5 0.10-0.25	≤10.0 0.10-0.25	≤5.0 0.10-0.20	≤2.5 0.10-0.15
				JM	60 (50-100)	≤7.5 0.10-0.15	≤5.0 0.10-0.15	≤2.5 0.10-0.15	≤10.0 0.10-0.15	≤7.5 0.10-0.15	≤5.0 0.10-0.15	≤2.5 0.10-0.15
	Acier outil		≤ 300HB	WH	50 (40-80)	≤10.0 0.10-0.25	≤5.0 0.10-0.20	≤2.5 0.10-0.15	≤12.5 0.10-0.25	≤10.0 0.10-0.25	≤5.0 0.10-0.20	≤2.5 0.10-0.15
				JM	50 (40-80)	≤7.5 0.10-0.15	≤5.0 0.10-0.15	≤2.5 0.10-0.15	≤10.0 0.10-0.15	≤7.5 0.10-0.15	≤5.0 0.10-0.15	≤2.5 0.10-0.15
M Acier inoxydable	≤ 200HB	VP20RT	WH	40 (35-80)	≤10.0 0.08-0.15	≤5.0 0.08-0.15	≤2.5 0.05-0.10	≤12.5 0.08-0.15	≤10.0 0.08-0.15	≤5.0 0.08-0.15	≤2.5 0.05-0.10	
			JM	40 (35-80)	≤7.5 0.08-0.15	≤5.0 0.08-0.15	≤2.5 0.05-0.10	≤10.0 0.08-0.15	≤7.5 0.08-0.15	≤5.0 0.08-0.15	≤2.5 0.05-0.10	
K Fonte	Résistance à la traction ≤350MPa	VP15TF	WH	50 (40-80)	≤10.0 0.15-0.25	≤5.0 0.10-0.25	≤2.5 0.10-0.20	≤12.5 0.15-0.25	≤10.0 0.15-0.25	≤5.0 0.10-0.25	≤2.5 0.10-0.20	
			JM	50 (40-80)	≤7.5 0.10-0.20	≤5.0 0.10-0.20	≤2.5 0.10-0.20	≤10.0 0.10-0.20	≤7.5 0.10-0.20	≤5.0 0.10-0.20	≤2.5 0.10-0.20	
	Fonte ductile		Résistance à la traction ≤800MPa	WH	40 (35-80)	≤10.0 0.15-0.25	≤5.0 0.10-0.25	≤2.5 0.10-0.20	≤12.5 0.15-0.25	≤10.0 0.15-0.25	≤5.0 0.10-0.25	≤2.5 0.10-0.20
				JM	40 (35-80)	≤7.5 0.10-0.20	≤5.0 0.10-0.20	≤2.5 0.10-0.20	≤10.0 0.10-0.20	≤7.5 0.10-0.20	≤5.0 0.10-0.20	≤2.5 0.10-0.20
S Alliage titane	≤ 350HB	VP20RT	WH	35 (30-50)	≤5.0 0.05-0.10	≤3.5 0.05-0.10	≤2.0 0.05-0.10	≤7.5 0.05-0.10	≤5.0 0.05-0.10	≤3.5 0.05-0.10	≤2.0 0.05-0.10	
			JM	35 (30-50)	≤5.0 0.05-0.10	≤3.5 0.05-0.10	≤2.0 0.05-0.10	≤7.5 0.05-0.10	≤5.0 0.05-0.10	≤3.5 0.05-0.10	≤2.0 0.05-0.10	

Remarque 1) Les recommandations de données de coupe indiquées ci-dessus sont des valeurs générales initiales pour des machines et des pièces de grande rigidité. En cas de vibrations, veuillez adapter les données de coupe en conséquence.

Remarque 2) Pour le rainurage, veuillez utiliser des outils de grande stabilité, comme par exemple SPX4R05016WNES/BT50NES.

CONDITIONS DE COUPE RECOMMANDÉES (FRAISE à ALESAGE)

■ CONDITIONS DE COUPE POUR FRAISAGE D'ÉPAULEMENT

Matière	Dureté	Plaquette/Nuance Brise-copeaux	Vitesse de coupe Vc (m/min)	Profondeur de Passe ap (mm)	Largeur de coupe ae (mm)	Avance par dent fz (mm/dent)
P Acier doux	≤180HB	VP15TF JM	120 (100-140)	-0.5DC	-10	0.15-0.30
			120 (100-140)	0.5DC-	-10	0.15-0.25
	180-350HB	VP15TF JM	120 (80-130)	-0.5DC	-10	0.15-0.30
			100 (80-120)	0.5DC-	-10	0.15-0.25
Acier outil	≤300HB	VP15TF JM	100 (60-110)	-0.5DC	-10	0.10-0.20
			80 (60-100)	0.5DC-	-10	0.10-0.15
M Acier inoxydable	≤200HB	VP20RT JM	140 (100-150)	-0.5DC	-10	0.10-0.25
			120 (100-140)	0.5DC-	-10	0.10-0.20
K Fonte grise	Résistance à la traction ≤350MPa	VP15TF WH	120 (80-130)	-0.5DC	-10	0.25-0.40
			100 (80-120)	0.5DC-	-10	0.25-0.40
		VP15TF JM	120 (80-130)	-0.5DC	-10	0.15-0.30
			100 (80-120)	0.5DC-	-10	0.15-0.25
Fonte ductile	Résistance à la traction ≤800MPa	VP15TF WH	100 (60-110)	-0.5DC	-10	0.20-0.35
			80 (60-110)	0.5DC-	-10	0.20-0.35
		VP15TF JM	100 (60-120)	-0.5DC	-10	0.15-0.30
			80 (60-120)	0.5DC-	-10	0.15-0.30
S Alliage titane	≤350HB	VP20RT JM	45 (35-50)	-0.5DC	-10	0.08-0.10
			40 (35-50)	0.5DC-	-10	0.08-0.10

Remarque 1) Les recommandations de données de coupe indiquées ci-dessus sont des valeurs générales initiales pour des machines et des pièces de grande rigidité. En cas de vibrations, veuillez adapter les données de coupe en conséquence.

■ CONDITIONS DE COUPE POUR RAINURAGE

Matière	Dureté	Plaquette/Nuance Brise-copeaux	Vitesse de coupe Vc (m/min)	Profondeur de Passe ap (mm)	Largeur de coupe ae (mm)	Avance par dent fz (mm/dent)
P Acier doux	≤180HB	VP15TF JM	120 (100-140)	-10	DC	0.15-0.25
	180-350HB	VP15TF JM	100 (80-120)	-0.25DC	DC	0.15-0.25
			80 (60-100)	-10	DC	0.10-0.20
M Acier inoxydable	≤200HB	VP20RT JM	100 (80-140)	-10	DC	0.10-0.15
K Fonte grise	Résistance à la traction ≤350MPa	VP15TF WH	80 (60-100)	-0.25DC	DC	0.10-0.25
			60 (50-100)	-0.6DC	DC	0.10-0.20
		VP15TF JM	80 (60-100)	-0.25DC	DC	0.10-0.20
			60 (50-100)	-0.6DC	DC	0.10-0.15
Fonte ductile	Résistance à la traction ≤800MPa	VP15TF WH	80 (60-100)	-0.25DC	DC	0.10-0.25
			60 (50-100)	-0.5DC	DC	0.10-0.20
		VP15TF JM	80 (60-100)	-0.25DC	DC	0.10-0.20
			60 (50-100)	-0.5DC	DC	0.10-0.15
S Alliage titane	≤350HB	VP20RT JM	40 (35-50)	-0.25DC	DC	0.06-0.10

Remarque 1) Les recommandations de données de coupe indiquées ci-dessus sont des valeurs générales initiales pour des machines et des pièces de grande rigidité. En cas de vibrations, veuillez adapter les données de coupe en conséquence.

K

FRAISES À PLAQUETTES

FRAISES À PLAQUETTES

FRAISES À SURFACER-DRESSER

<ALLIAGE TITANE ET MATERIAUX DIFFICILES A USINER>



ASPX

NEW

P M K N **S** H

K

FRAISES À PLAQUETTES

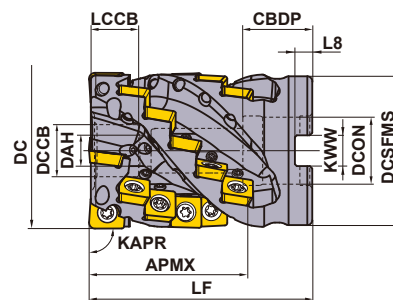

Outil à droite uniquement.

Diamètre fraise DC (mm)	Vis d'attachement	Géométrie
φ50	HSC10070	
φ63	HSC12070	
φ80	HSC16080	

FRAISE à ALÉSAGE

KAPR: 90°

Avec trou d'arrosage : les corps à alésage doivent être combinés avec un porte-fraise à canaux d'arrosage continus.

DC (mm)	Référence	Stock R	Nbre goujures	Total	Dimensions (mm)		WT (kg)	APMX (mm)
					LF	DCON		
50	ASPX4-050A03A054RA15	●	3	15	85	22	0.6	54
63	ASPX4-063A04A064RA24	●	4	24	90	27	1.0	64
80	ASPX4-080A05A075RA35	●	5	35	100	32	2.0	75

DIMENSIONS DE MONTAGE

DC (mm)	Référence	Dimensions (mm)							
		DCON	CBDP	DAH	DCCB	LCCB	DCSFMS	KWW	L8
50	ASPX4-050A03A054RA15	22	21	10.5	17	14	47	10.4	6.3
63	ASPX4-063A04A064RA24	27	28	12.5	21	19	60	12.4	7
80	ASPX4-080A05A075RA35	32	28	16.5	27	20	76	14.4	8

PIÈCES DÉTACHÉES

Référence porte-outil	* (Icons: Torx screw, Washer, Key, Coolant hose, Qty, Antistatic)						Nombre de dents	
	Vis de serrage	Rondelle d'étanchéité	Clé	Buse de liquide réfrigérant	Qté	Antigrippant	JPGX	SPGX
ASPX4-050A	TS55	W10-S1	TKY25D	HSD04004H08	18	MK1KS	3	12
ASPX4-063A	TS55	W12-S1	TKY25D	HSD04004H08	28	MK1KS	4	20
ASPX4-080A	TS55	W16-S1	TKY25D	HSD04004H08	40	MK1KS	5	30

* Couple de serrage (N • m) : TS55 = 5.0

	≤1Mpa (≤20 l/min.)	←Standard→	≥5Mpa (≥30 l/min.)	≥7Mpa (≥50 l/min.)	Bouchon obturateur
Diam.de buse	ø0.6mm	ø0.8mm	ø1.2mm	ø1.6mm	—
Référence	HSD04004H06	HSD04004H08	HSD04004H12	HSD04004H16	HSS04004

Remarque 1) Des buses d'arrosage de différents diamètres sont disponibles pour s'adapter à la pression d'arrosage disponible.

Veuillez sélectionner la buse selon le tableau ci-dessus.

Remarque 2) Utiliser HSS04004 (JIS B 1177 bout plat M4x4, couple de serrage 1,5 Nm) pour obturer le trou d'arrosage.

● : Article stocké. ★ : Article standard Japon.

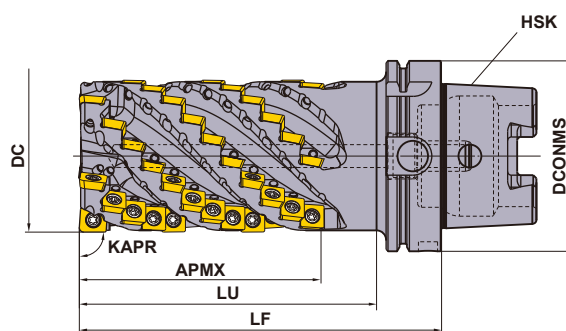

Outils standard disponibles uniquement à droite (R). Les outils HSK sont fournis avec la pipette d'arrosage.

K

FRAISES À PLAQUETTES





MONOBLOC HSK

KAPR: 90°

Avec trou de lubrification

DC	Référence	Stock R	Nbre goujures	Total	Dimensions (mm)			HSK	APMX (mm)
					LF	LU	DCONMS		
80	ASPX4R0805H100A127SA	★	5	60	190	156	100	HSK-A100	127
80	ASPX4R0805H125A127SA	★	5	60	190	156	125	HSK-A125	127



PIÈCES DÉTACHÉES

Référence porte-outil	* 								Nombre de dents	
	Vis de serrage	Clé	Buse de liquide réfrigérant	Qté	Antigrippant	JPGX	SPGX			
ASPX4R0805H100A	TS55	TKY25D	HSD04004H08	65	MK1KS	5	55			
ASPX4R0805H125A	TS55	TKY25D	HSD04004H08	65	MK1KS	5	55			

* Couple de serrage TS55 : 5,0 Nm

FRAISES À PLAQUETTES

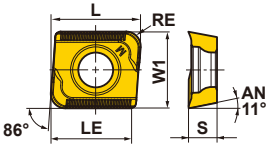
PLAQUETTES

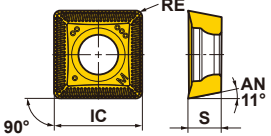
Matière	S	Alliage réfractaire, Alliage titane	●				Conditions de coupe (Guide): ● : Coupe Stable ● : Coupe Générale ✖ : Coupe Instable Honing : E : Ronde				
	Forme	Référence	Classe Honing	Revêtu	Dimensions (mm)						Géométrie
				MP9140	L	LE	W1	IC	S	RE	
Plaque en bout  2 arêtes	JPGX1404080PPER-JM	G E ●			15.12	13.4	12.7	—	4.8	0.8	
	JPGX1404120PPER-JM	G E ●			15.06	13.3	12.7	—	4.8	1.2	
	JPGX1404160PPER-JM	G E ●			15.00	13.3	12.7	—	4.8	1.6	
	JPGX1404240PPER-JM	G E ●			14.88	13.2	12.7	—	4.8	2.4	
	JPGX1404320PPER-JM	G E ●			14.72	13.1	12.7	—	4.8	3.2	
	JPGX1404400PPER-JM	G E ●			14.64	13.0	12.7	—	4.8	4.0	
	JPGX1404500PPER-JM	G E ●			14.49	13.0	12.7	—	4.8	5.0	
	JPGX1404635PPER-JM	G E ●			14.29	12.9	12.7	—	4.8	6.35	
Plaque latérale  4 arêtes	SPGX1204100PPER-JM	G E ●			—	—	—	12.7	4.8	1.0	

CONDITIONS DE COUPE RECOMMANDÉES

Matière	Largueur de coupe ae (mm)	Vitesse de coupe Vc (m/min)	Avance par dent fz (mm/dent)
S Alliages de titane Ti-6Al-4V, Ti-6Al-4V-ELI Ti-10V-2Fe-3Al Ti-5Al-5V-5Mo-3Cr etc.	ae ≤ 0.5DC	60(50—80)	0.12(0.10—0.14)
	0.5DC < ae < 0.8DC	50(40—60)	0.10(0.08—0.12)
	ae ≥ 0.8DC	40(50—60)	0.08(0.06—0.10)

Remarque 1) La performance de coupe dépend de la raideur de la machine et du bridage, ainsi que des débit et pression d'arrosage. Ajuster si nécessaire.

Remarque 2) Utiliser une machine et une puissance de broche adaptées à l'usinage lourd des alliages de titane. (Cône 7/24 #50 ou #60, ou HSK-A100 ou A125 haute rigidité, avec une puissance de 15 kW ou supérieure et un couple de 500 Nm ou supérieur pour une vitesse de rotation de 500 tr/min ou inférieure).

Attention, dans des conditions de coupe à forte charge, la puissance admissible de la broche peut être dépassée.

Remarque 3) En cas de broutement et de vibration ou de surcharge de la machine, il est recommandé de réduire la profondeur de passe ap.

Remarque 4) Nous préconisons un arrosage combine interne et externe ; il est recommandé de fournir un débit d'arrosage suffisant.

Remarque 5) Une entrée progressive en rayon dans la pièce à usiner et le fraisage en avalant recommandés. (Cf. page K211)

● : Article stocké.

K210 (10 plaquettes par boîte)

K

FRAISES À PLAQUETTES

Notice d'utilisation

Effets positifs d'une entrée en rayon

L'entrée en rayon limite les augmentations brusques de charge à la broche de coupe et évite l'écaillage des plaquettes qui est susceptible de se produire en début d'usinage.

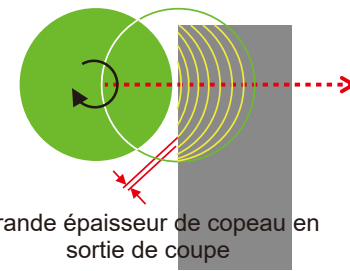
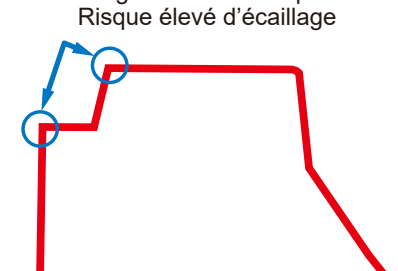
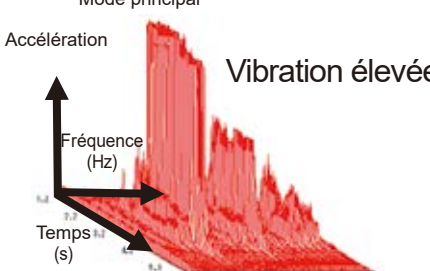
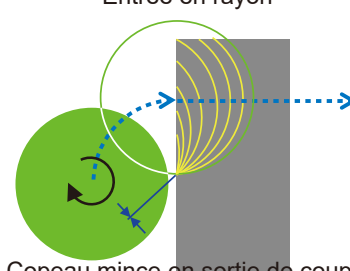
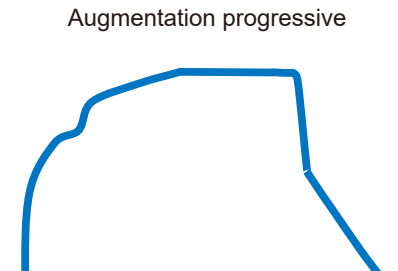
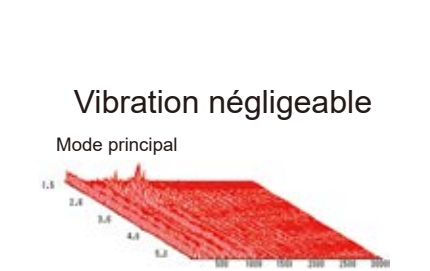
Méthode d'entrée	Charge de broche (simulation)	Intensité des vibrations
<p>Entrée directe</p>  <p>Grande épaisseur de copeau en sortie de coupe</p>	<p>Augmentation brusque Risque élevé d'écaillage</p> 	<p>Mode principal</p> <p>Accélération</p> <p>Fréquence (Hz)</p> <p>Temps (s)</p> <p>Vibration élevée</p> 
<p>Entrée en rayon</p>  <p>Copeau mince en sortie de coupe</p>	<p>Augmentation progressive</p> 	<p>Vibration négligeable</p> <p>Mode principal</p> 

Le fraisage en avalant recommandé.

Utilisation de plaquettes à grands rayons

Lors de l'utilisation de plaquettes avec un rayon $RE \geq 3,2$ mm, reprendre le corps de fraise avec une forme rayonnée selon le tableau ci-dessous.



Rayon plaquette (RE)

Corps de fraise R

Rayon plaquette RE (mm)	Rayon du corps de fraise R (mm)
3.2	3.0
4.0	4.0
5.0	5.0
6.35	6.2

FRAISES À PLAQUETTES

FRAISE HÉMISPHERIQUE

SRF/SRB



P M **K** N S H

K

FRAISES À PLAQUETTES



Fig.1

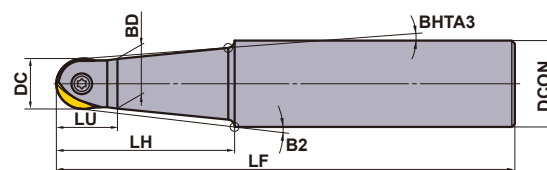

Fig.2

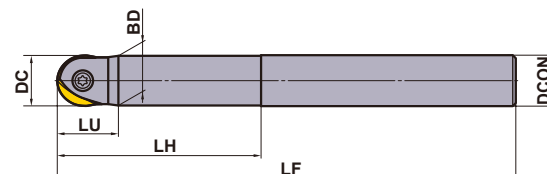
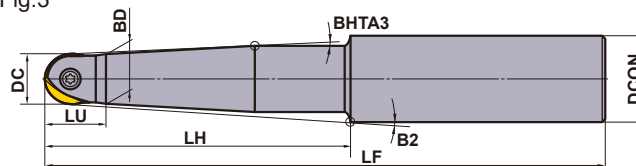

Fig.3



Outil à droite uniquement.

■ CORPS ACIER

Type	Référence	Stock	Nombre de dents	Dimensions (mm)								Fig.	*1 Vis de fixation	*2 Clé	Plaquette	
				RE*2	DC	DCON	LF	BD	LH	LU	B2					BHTA3
Standard	SRFH10S12M	●	1	5	10	12	110	9.5	40	13	1.63°	1.5°	1	RS3008T	①TKY08D	SRFT10 SRBT10
	SRFH12S16M	●	1	6	12	16	120	11.5	50	15	2.6°	1.5°	1	RS3510T	①TKY10D	SRFT12 SRBT12
	SRFH16S20M	●	1	8	16	20	130	15.5	50	20	2.73°	1.5°	1	RS4015T	②TKY15T	SRFT16 SRBT16
	SRFH20S25M	●	1	10	20	25	150	19.5	70	24	2.38°	1.5°	1	RS5020T	②TKY20T	SRFT20 SRBT20
	SRFH25S32M	●	1	12.5	25	32	180	24.5	80	30	2.97°	1.5°	1	RS6025T	②TKY25T	SRFT25 SRBT25
	SRFH30S32M	●	1	15	30	32	200	29.5	100	35	—	—	2	RS8030T	②TKY30T	SRFT30 SRBT30
	SRFH32S32M	●	1	16	32	32	200	31.5	100	35	—	—	2	RS8030T	②TKY30T	SRFT32 SRBT32
Semi-longue	SRFH10S12L	●	1	5	10	12	150	9.5	60	13	1.5°	1.5°	1	RS3008T	①TKY08D	SRFT10 SRBT10
	SRFH12S16L	●	1	6	12	16	160	11.5	70	15	1.78°	1.5°	1	RS3510T	①TKY10D	SRFT12 SRBT12
	SRFH16S20L	●	1	8	16	20	160	15.5	70	20	1.85°	1.5°	1	RS4015T	②TKY15T	SRFT16 SRBT16
	SRFH20S25L	●	1	10	20	25	180	19.5	80	24	2.05°	1.5°	1	RS5020T	②TKY20T	SRFT20 SRBT20
	SRFH20S20L80	●	1	10	20	20	180	19.5	80	24	—	—	2	RS5020T	②TKY20T	SRFT20 SRBT20
	SRFH25S32L	★	1	12.5	25	32	200	24.5	100	30	2.28°	1.5°	1	RS6025T	②TKY25T	SRFT25 SRBT25
	SRFH25S25L100	●	1	12.5	25	25	200	24.5	100	30	—	—	2	RS6025T	②TKY25T	SRFT25 SRBT25
SRFH30S32L	★	1	15	30	32	230	29.5	130	35	—	—	2	RS8030T	②TKY30T	SRFT30 SRBT30	
Série Longue	SRFH20S25E	●	1	10	20	25	220	19.5	120	24	1.5°	1.5°	3	RS5020T	②TKY20T	SRFT20 SRBT20
	SRFH20S20E120	●	1	10	20	20	220	19.5	120	24	—	—	2	RS5020T	②TKY20T	SRFT20 SRBT20
	SRFH25S32E	●	1	12.5	25	32	250	24.5	150	30	1.5°	1.5°	3	RS6025T	②TKY25T	SRFT25 SRBT25
	SRFH25S25E150	●	1	12.5	25	25	250	24.5	150	30	—	—	2	RS6025T	②TKY25T	SRFT25 SRBT25
	SRFH30S32E	●	1	15	30	32	300	29.5	200	35	—	—	2	RS8030T	②TKY30T	SRFT30 SRBT30

*1 Couple de serrage (N • m) : RS3008T=1,5, RS3510T=2,5, RS4015T=3,3, RS5020T=5,0, RS6025T=7,5, RS8030T=10,0

*2 RE est défini par le rayon de plaquette R.

● : Article stocké. ★ : Article standard Japon.



Fig.1

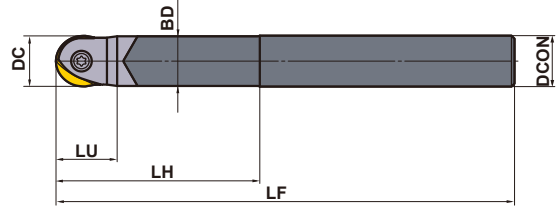

Outil à droite uniquement.

■ CORPS CARBURE

Type	Référence	Stock	Nombre de dents	Dimensions (mm)							Fig.	*1	①	②	Plaque
				RE*2	DC	DCON	LF	BD	LH	LU					
Standard	SRFH10S10MW	●	1	5	10	10	110	9.5	40	13	1	RS3008T	①TKY08D	SRFT10 SRBT10	
	SRFH12S12MW	●	1	6	12	12	120	11.5	50	15	1	RS3510T	①TKY10D	SRFT12 SRBT12	
	SRFH16S16MW	●	1	8	16	16	130	15.5	50	20	1	RS4015T	②TKY15T	SRFT16 SRBT16	
	SRFH20S20MW	●	1	10	20	20	180	19.5	80	24	1	RS5020T	②TKY20T	SRFT20 SRBT20	
	SRFH25S25MW	●	1	12.5	25	25	200	24.5	100	30	1	RS6025T	②TKY25T	SRFT25 SRBT25	
	SRFH30S32MW	★	1	15	30	32	230	29.5	130	35	1	RS8030T	②TKY30T	SRFT30 SRBT30	
			16	32	32	231	29.5	131	36	SRFT32 SRBT32					
Série Longue	SRFH10S10LW	●	1	5	10	10	150	9.5	60	13	1	RS3008T	①TKY08D	SRFT10 SRBT10	
	SRFH12S12LW	●	1	6	12	12	160	11.5	70	15	1	RS3510T	①TKY10D	SRFT12 SRBT12	
	SRFH16S16LW	●	1	8	16	16	160	15.5	70	20	1	RS4015T	②TKY15T	SRFT16 SRBT16	
	SRFH16S16EW	●	1	8	16	16	200	15.5	110	20	1	RS4015T	②TKY15T	SRFT16 SRBT16	
	SRFH20S20LW	●	1	10	20	20	250	19.5	150	24	1	RS5020T	②TKY20T	SRFT20 SRBT20	
	SRFH25S25LW	★	1	12.5	25	25	300	24.5	200	30	1	RS6025T	②TKY25T	SRFT25 SRBT25	
	SRFH30S32LW	★	1	15	30	32	350	29.5	250	35	1	RS8030T	②TKY30T	SRFT30 SRBT30	
			16	32	32	351	29.5	251	36	SRFT32 SRBT32					

Remarque 1) Les corps SRFH30S32MW et SRFH30S32LW peuvent être chacun équipé de la plaque SRFT30 ou SRFT32.
La longueur totale LF est cependant différente.

*1 Couple de serrage (N • m) : RS3008T=1,5, RS3510T=2,5, RS4015T=3,3, RS5020T=5,0, RS6025T=7,5, RS8030T=10,0

*2 RE est défini par le rayon de plaque R.

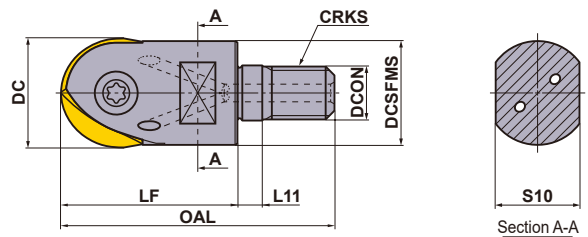

■ FRAISE À EMBOUT FILETÉ

Outil à droite uniquement.

Référence	Stock	Trou d'arrosage	Nombre de dents	Dimensions (mm)								*3 WT (kg)	*1	Clé	Plaque	
				RE*2	DC	DCON	DCSFMS	OAL	LF	L11	S10					CRKS
SRFH16AM0830	●	○	1	8	16	8.5	14.9	48	30	6	10	8	0.1	RS4015T	TKY15T	SRFT16 SRBT16
SRFH20AM1035	●	○	1	10	20	10.5	18.4	54	35	6	14	10	0.1	RS5020T	TKY20T	SRFT20 SRBT20
SRFH25AM1240	●	○	1	12.5	25	12.5	23.5	62	40	6	19	12	0.1	RS6025T	TKY25T	SRFT25 SRBT25
SRFH30AM1645	●	○	1	15	30	17	28.1	68	45	6	24	16	0.2	RS8030T	TKY30T	SRFT30 SRBT30
				16	32	17	28.1	69	46	6	24	16	0.2			SRFT32 SRBT32

Remarque 1) Les corps SRFH30AM1645 peuvent être chacun équipé de la plaque SRFT30 ou SRFT32.

La longueur totale OAL est cependant différente.

Remarque 2) Pour les arbres vissables, veuillez vous référer à la page K244.

*1 Couple de serrage (N • m) : RS4015T=3,3, RS5020T=5,0, RS6025T=7,5, RS8030T=10,0



*2 RE est défini par le rayon de plaque R.

*3 WT : Poids de l'outil

RALLONGES	> K244
PIÈCES DÉTACHÉES	> N001
DONNÉES TECHNIQUES	> P001

FRAISES À PLAQUETTES

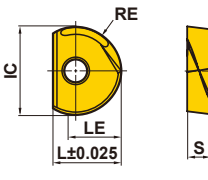
PLAQUETTES

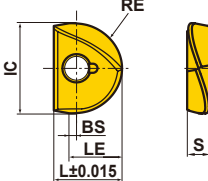
Matière	P	Acier	●	●	●	Conditions de coupe : ● : Coupe Stable ● : Coupe Générale ✖ : Coupe Instable							
	M	Acier Inoxydable	●	●	●								
Forme	K	Fonte	●	●	●								
	N	Non ferreux	●	●	●								
	H	Acier trempé	●	●	●								
Forme	Référence	Revêtu			Dimensions (mm)						Géométrie		
		EP6120	VP15TF	MP8010	IC	RE		L	LE	BS		S	
						Rayon	Tolérance						
	SRBT10	●	●		10	5	±0.02	8.5	5	—	2.6		
	SRBT12	●	●		12	6	±0.02	10	6	—	3		
	SRBT16	●	●		16	8	±0.025	12	8	—	4		
	SRBT20	●	●		20	10	±0.025	15	10	—	5		
	SRBT25	●	●		25	12.5	±0.035	18.5	12.5	—	6		
	SRBT30	●	●		30	15	±0.035	22.5	15	—	7		
	SRBT32	●	●		32	16	±0.035	23.5	16	—	7		
	SRFT10	●	●	●	10	5	±0.006	8.5	5.5	0.5	2.6		
	SRFT12	●	●	●	12	6	±0.006	10	6.5	0.5	3		
	SRFT16	●	●	●	16	8	±0.006	12	9	1	4		
	SRFT20	●	●	●	20	10	±0.006	15	11	1	5		
	SRFT25	●	●	●	25	12.5	±0.006	18.5	13.5	1	6		
	SRFT30	●	●	●	30	15	±0.006	22.5	16	1	7		
	SRFT32	●	●	●	32	16	±0.006	23.5	17	1	7		

MONTAGE DES PLAQUETTES

1. Nettoyer le logement de plaquette

Nettoyer le logement de plaquette à l'air comprimé ou à l'aide d'une brosse.

2. Installer la plaquette

Placer l'encoche de la plaquette du côté de la tête de la vis de serrage (plaquettes de type SRF uniquement). Serrer la vis de serrage en maintenant la plaquette appuyée dans son logement. Il est recommandé d'utiliser le lubrifiant spécial MK1KS pour éviter le grippage de la vis et de serrer la vis au couple recommandé.



CONDITIONS DE COUPE RECOMMANDÉES

	Matière	Dureté	Nuance	Vitesse de coupe V_c (m/min)	Avance par dent f_z (mm/dent)	Épaisseur de coupe a_p (mm)
P	Acier doux	≤180HB	EP6120	200 (80–300)	0.2 (0.1–0.3)	≤0.05DC
	Acier carbone, Alliage acier	180–280HB	EP6120	200 (80–300)	0.2 (0.1–0.3)	≤0.05DC
			VP15TF	200 (80–300)	0.2 (0.1–0.3)	≤0.05DC
	Acier carbone, Alliage acier	280–350HB	EP6120	200 (80–300)	0.2 (0.1–0.3)	≤0.05DC
	Acier pré-traité	35–45HRC	EP6120	150 (80–200)	0.2 (0.1–0.3)	≤0.05DC
			VP15TF	150 (80–200)	0.2 (0.1–0.3)	≤0.05DC
Acier outil	≤350HB	EP6120	150 (80–200)	0.2 (0.1–0.3)	≤0.05DC	
		VP15TF	150 (80–200)	0.2 (0.1–0.3)	≤0.05DC	
K	Fonte grise	Résistance à la traction ≤350MPa	MP8010	250 (80–450)	0.2 (0.1–0.3)	≤0.05DC
	Fonte ductile	Résistance à la traction ≤450MPa	MP8010	200 (80–300)	0.2 (0.1–0.3)	≤0.05DC
	Fonte ductile	Résistance à la traction ≤800MPa	MP8010	200 (80–300)	0.2 (0.1–0.3)	≤0.05DC
N	Cuivre, Alliage cuivre	—	EP6120	200 (80–300)	0.2 (0.1–0.3)	≤0.05DC
H	Acier trempé	45–55HRC	MP8010	100 (60–120)	0.2 (0.1–0.3)	≤0.05DC
	Acier trempé	55–65HRC	MP8010	80 (60–120)	0.2 (0.1–0.3)	≤0.01DC

K

FRAISES À PLAQUETTES

Remarque 1) Les valeurs ci-dessus sont des valeurs de condition moyennes aux vitesses de coupe effectives. Les valeurs peuvent varier légèrement en fonction de la machine à utiliser et de la méthode de fixation. Veuillez régler les valeurs en fonction de l'état de la machine, en vous rapportant aux valeurs ci-dessus.

Remarque 2) En ce qui concerne les fraises d'ébauche avec queue carbure, vous pourrez augmenter les conditions de coupe d'environ 20 pour cent.

Remarque 3) Veuillez noter les indications suivantes lorsque vous procéderez à l'usinage de l'acier trempé avec MP8010.

- Réduire autant que possible le porte-à-faux.
- L'utilisation d'un corps carbure est recommandée.
- Vérifier la profondeur de passe pour éviter l'écaillage de l'arête.

CALCUL VITESSE DE COUPE

1. En fonction de θ° ➔ Calculez la vitesse de coupe au point P.
(Vitesse de coupe à la périphérie usinée avec fraise inclinée)

$$\text{Formule : Vitesse de coupe} = \frac{\pi \cdot DC \cdot \sin \theta \cdot n}{1000} \text{ (m/min)}$$

$$\theta^\circ = \cos^{-1} \left(\frac{DC - 2a_p}{DC} \right) + 90 - \alpha$$

n : Régime (min^{-1})

2. En fonction de a_p ➔ Calculez vitesse de coupe au point Q.
(Vitesse de coupe à la périphérie)

$$\text{Formule : Vitesse de coupe} = \frac{2\pi n \sqrt{a_p (DC - a_p)}}{1000} \text{ (m/min)}$$

n : Régime (min^{-1})

DC : Diamètre de l'arête de coupe (mm)

a_p : Profondeur de passe (mm)

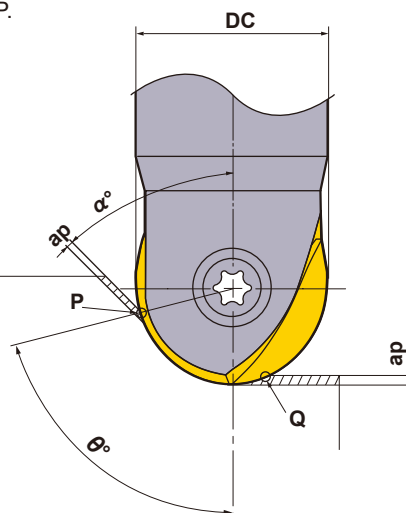

FRAISES À PLAQUETTES

FRAISES TORIQUES à PLAQUETTE



SUF

- P
- M
- K
- N
- S
- H

K

FRAISES À PLAQUETTES



Fig.1

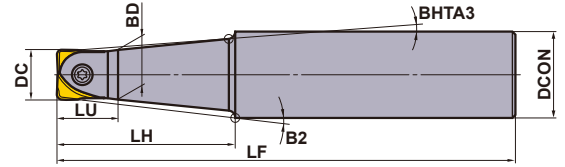

Fig.2

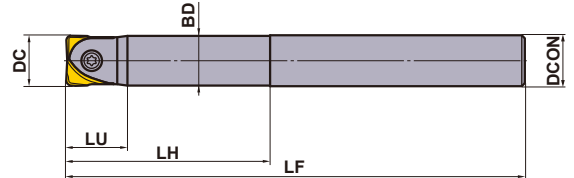
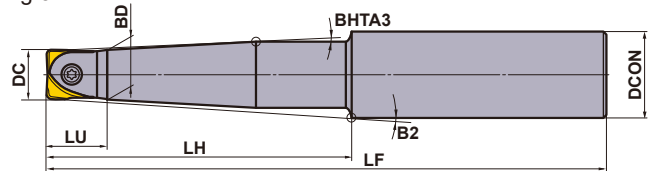

Fig.3



■ CORPS ACIER

Outil à droite uniquement.

Type	Référence	Stock	Nombre de dents	Dimensions (mm)								Fig.			
				DC	DCON	LF	BD	LH	LU	B2	BHTA3		Vis de fixation	Clé	Plaquette
Standard	SRFH10S12M	●	1	10	12	110	9.5	40	13	1.63°	—	1	RS3008T	①TKY08D	SUFT10R
	SRFH12S16M	●	1	12	16	120	11.5	50	15	2.60°	—	1	RS3510T	①TKY10D	SUFT12R
	SRFH16S20M	●	1	16	20	130	15.5	50	20	2.73°	—	1	RS4015T	②TKY15T	SUFT16R
	SRFH20S25M	●	1	20	25	150	19.5	70	24	2.38°	1.5°	1	RS5020T	②TKY20T	SUFT20R
	SRFH25S32M	●	1	25	32	180	24.5	80	30	2.97°	1.5°	1	RS6025T	②TKY25T	SUFT25R
	SRFH30S32M	●	1	30	32	200	29.5	100	35	—	—	2	RS8030T	②TKY30T	SUFT30R
	SRFH32S32M	●	1	32	32	200	31.5	100	35	—	—	2	RS8030T	②TKY30T	SUFT32R
Semi-longue	SRFH10S12L	●	1	10	12	150	9.5	60	13	1.5°	—	1	RS3008T	①TKY08D	SUFT10R
	SRFH12S16L	●	1	12	16	160	11.5	70	15	1.78°	—	1	RS3510T	①TKY10D	SUFT12R
	SRFH16S20L	●	1	16	20	160	15.5	70	20	1.85°	—	1	RS4015T	②TKY15T	SUFT16R
	SRFH20S25L	●	1	20	25	180	19.5	80	24	2.05°	1.5°	1	RS5020T	②TKY20T	SUFT20R
	SRFH20S20L80	●	1	20	20	180	19.5	80	24	—	—	2	RS5020T	②TKY20T	SUFT20R
	SRFH25S32L	★	1	25	32	200	24.5	100	30	2.28°	1.5°	1	RS6025T	②TKY25T	SUFT25R
	SRFH25S25L100	●	1	25	25	200	24.5	100	30	—	—	2	RS6025T	②TKY25T	SUFT25R
SRFH30S32L	★	1	30	32	230	29.5	130	35	—	—	2	RS8030T	②TKY30T	SUFT30R	
Série Longue	SRFH20S25E	●	1	20	25	220	19.5	120	24	1.5°	1.5°	3	RS5020T	②TKY20T	SUFT20R
	SRFH20S20E120	●	1	20	20	220	19.5	120	24	—	—	2	RS5020T	②TKY20T	SUFT20R
	SRFH25S32E	●	1	25	32	250	24.5	150	30	1.5°	1.5°	3	RS6025T	②TKY25T	SUFT25R
	SRFH25S25E150	●	1	25	25	250	24.5	150	30	—	—	2	RS6025T	②TKY25T	SUFT25R
	SRFH30S32E	●	1	30	32	300	29.5	200	35	—	—	2	RS8030T	②TKY30T	SUFT30R

* Couple de serrage (N · m) : RS3008T=1,5, RS3510T=2,5, RS4015T=3,3, RS5020T=5,0, RS6025T=7,5, RS8030T=10,0

● : Article stocké. ★ : Article standard Japon.



Fig.1

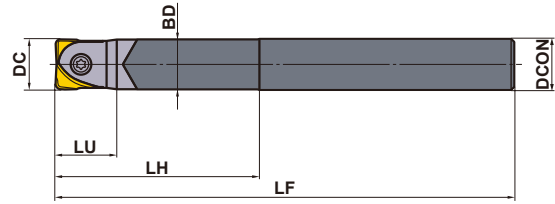

■ CORPS CARBURE

Outil à droite uniquement.

Type	Référence	Stock	R	Nombre de dents	Dimensions (mm)					Fig.	* Vis de fixation	① Clé	② Plaquette	
					DC	DCON	LF	BD	LH					LU
Standard	SRFH10S10MW	●	1	1	10	10	110	9.5	40	13	1	RS3008T	①TKY08D	SUFT10R
	SRFH12S12MW	●	1	1	12	12	120	11.5	50	15	1	RS3510T	①TKY10D	SUFT12R
	SRFH16S16MW	●	1	1	16	16	130	15.5	50	20	1	RS4015T	②TKY15T	SUFT16R
	SRFH20S20MW	●	1	1	20	20	180	19.5	80	24	1	RS5020T	②TKY20T	SUFT20R
	SRFH25S25MW	●	1	1	25	25	200	24.5	100	30	1	RS6025T	②TKY25T	SUFT25R
	SRFH30S32MW	★	1	1	30	32	230	29.5	130	35	1	RS8030T	②TKY30T	SUFT30R
				32	32	231	29.5	131	36	SUFT32R				
Série Longue	SRFH10S10LW	●	1	1	10	10	150	9.5	60	13	1	RS3008T	①TKY08D	SUFT10R
	SRFH12S12LW	●	1	1	12	12	160	11.5	70	15	1	RS3510T	①TKY10D	SUFT12R
	SRFH16S16LW	●	1	1	16	16	160	15.5	70	20	1	RS4015T	②TKY15T	SUFT16R
	SRFH20S20LW	●	1	1	20	20	250	19.5	150	24	1	RS5020T	②TKY20T	SUFT20R
	SRFH25S25LW	★	1	1	25	25	300	24.5	200	30	1	RS6025T	②TKY25T	SUFT25R
	SRFH30S32LW	★	1	1	30	32	350	29.5	250	35	1	RS8030T	②TKY30T	SUFT30R
				32	32	351	29.5	251	36	SUFT32R				

Remarque 1) Le corps de l'outil SRFH30S32MW et SRFH30S32LW peut accueillir des plaquettes SUFT30R et SUFT32R.
Cependant, la taille LF de la longueur totale est différente respectivement.

* Couple de serrage (N • m) : RS3008T=1,5, RS3510T=2,5, RS4015T=3,3, RS5020T=5,0, RS6025T=7,5, RS8030T=10,0

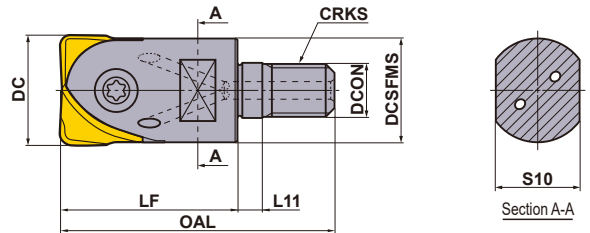

■ FRAISE À EMBOUT FILETÉ

Outil à droite uniquement.

Référence	Stock	R	Trou d'aarage	Nombre de dents	Dimensions (mm)							*2 WT (kg)	*1 Vis de fixation	Clé	Plaquette	
					DC	DCON	DCSFMS	OAL	LF	L11	S10					CRKS
SRFH16AM0830	●	○	1	1	16	8.5	14.9	48	30	6	10	8	0.1	RS4015T	TKY15T	SUFT16R
SRFH20AM1035	●	○	1	1	20	10.5	18.4	54	35	6	14	10	0.1	RS5020T	TKY20T	SUFT20R
SRFH25AM1240	●	○	1	1	25	12.5	23.5	62	40	6	19	12	0.1	RS6025T	TKY25T	SUFT25R
SRFH30AM1645	●	○	1	1	30	17	28.1	68	45	6	24	16	0.2	RS8030T	TKY30T	SUFT30R
					32	17	28.1	69	46	6	24	16				SUFT32R

Remarque 1) Le corps de l'outil SRFH30AM1645 peut accueillir des plaquettes SUFT30R et SUFT32R.

Cependant, la taille OAL de la longueur totale est différente respectivement.

Remarque 2) Pour les arbres vissables, veuillez vous référer à la page K244.

*1 Couple de serrage (N • m) : RS4015T=3,3, RS5020T=5,0, RS6025T=7,5, RS8030T=10,0

*2 WT : Poids de l'outil

RALLONGES	> K244
PIÈCES DÉTACHÉES	> N001
DONNÉES TECHNIQUES	> P001

FRAISES À PLAQUETTES

PLAQUETTES

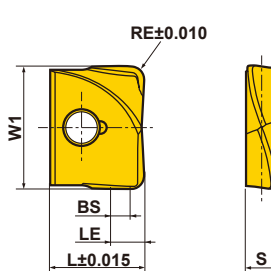
Matière	P	Acier			Conditions de coupe :					Géométrie	
	M	Acier Inoxydable									● : Coupe Stable ● : Coupe Générale ✱ : Coupe Instable
Forme	K	Fonte	Revêtu		Dimensions (mm)					Géométrie	
	H	Acier trempé	MP8010	VP15TF	W1	RE	BS	LE	L		S
			●	●	10	0.5	1	1.5	8.5	2.6	
			●	●	10	1	1	2	8.5	2.6	
			●	★	10	2	1	3	8.5	2.6	
			●	●	12	0.5	1.2	1.7	10	3	
			●	●	12	1	1.2	2.2	10	3	
			●	●	12	2	1.2	3.2	10	3	
			★	●	12	3	1.2	4.2	10	3	
			●	●	16	0.5	1.6	2.1	12	4	
			●	●	16	1	1.6	2.6	12	4	
			★	●	16	1.5	1.6	3.1	12	4	
			●	●	16	2	1.6	3.6	12	4	
			★	●	16	3	1.6	4.6	12	4	
			●	●	20	0.5	2	2.5	15	5	
			●	●	20	1	2	3	15	5	
			★	●	20	1.5	2	3.5	15	5	
			●	●	20	2	2	4	15	5	
			●	●	20	3	2	5	15	5	
			★	●	25	0.5	2.5	3	18.5	6	
			●	★	25	1	2.5	3.5	18.5	6	
			★	●	25	2	2.5	4.5	18.5	6	
			★	●	25	3	2.5	5.5	18.5	6	
			★	★	30	0.5	3	3.5	22.5	7	
			★	★	30	1	3	4	22.5	7	
			★	★	30	2	3	5	22.5	7	
			★	★	30	3	3	6	22.5	7	
			★	★	32	0.5	3.2	3.7	23.5	7	
			★	★	32	1	3.2	4.2	23.5	7	
			★	★	32	2	3.2	5.2	23.5	7	

FRAISES À PLAQUETTES

K



MONTAGE DES PLAQUETTES

1. Nettoyer le logement de plaquette

Nettoyer le logement de plaquette à l'air comprimé ou à l'aide d'une brosse.

2. Installer la plaquette

Placer l'encoche de la plaquette du côté de la tête de la vis de serrage (plaquettes de type SRF uniquement). Serrer la vis de serrage en maintenant la plaquette appuyée dans son logement. Il est recommandé d'utiliser le lubrifiant spécial MK1KS pour éviter le grippage de la vis et de serrer la vis au couple recommandé.



● : Article stocké. ★ : Article standard Japon.
(2 plaquettes par boîte)

CONDITIONS DE COUPE RECOMMANDÉES

■ SURFACER-DRESSER (Faible ae^*)

	Matière	Dureté	Nuance	Vitesse de coupe V_c (m/min)	Profondeur de passe ap (mm)	Profondeur de passe ae (mm)	Avance par dent fz (mm/dent)
P	Acier carbone Acier allié	180–280HB	VP15TF	200 (80–300)	≤0.05DC	≤0.05DC	0.2 (≤0.4)
	Acier pré-traité	≤45HRC	VP15TF	150 (80–200)	≤0.05DC	≤0.05DC	0.15 (≤0.3)
	Acier outil	180–380HB	VP15TF	150 (80–200)	≤0.05DC	≤0.05DC	0.15 (≤0.3)
M	Acier inoxydable	≤270HB	VP15TF	150 (100–200)	≤0.05DC	≤0.05DC	0.2 (≤0.4)
K	Fonte grise	Résistance à la traction ≤350MPa	MP8010	250 (180–450)	≤0.05DC	≤0.1DC	0.3 (≤0.4)
	Fonte ductile	Résistance à la traction ≤800MPa	MP8010	200 (80–300)	≤0.05DC	≤0.1DC	0.3 (≤0.4)
H	Acier traité	45–55HRC	MP8010	100 (80–120)	≤0.05DC	≤0.02DC	0.1 (≤0.2)
	Acier traité	55–65HRC	MP8010	80 (60–100)	≤0.05DC	≤0.02DC	0.1 (≤0.2)

* Lorsque la direction du pas est dans l'axe de l'outil d'usinage, tels que l'usinage de finition des parois.

■ RAINURAGE • SURFACER - DRESSER (Fort ae^*)

	Matière	Dureté	Nuance	Vitesse de coupe V_c (m/min)	Profondeur de passe ap (mm)	Profondeur de passe ae (mm)	Avance par dent fz (mm/dent)
P	Acier carbone Acier allié	180–280HB	VP15TF	200 (80–300)	≤0.02DC	≤DC	0.2 (≤0.4)
	Acier pré-traité	≤45HRC	VP15TF	150 (80–200)	≤0.02DC	≤DC	0.15 (≤0.3)
	Acier outil	180–380HB	VP15TF	150 (80–200)	≤0.02DC	≤DC	0.15 (≤0.3)
M	Acier inoxydable	≤270HB	VP15TF	150 (100–200)	≤0.02DC	≤DC	0.2 (≤0.4)
K	Fonte grise	Résistance à la traction ≤350MPa	MP8010	250 (180–450)	≤0.03DC	≤DC	0.3 (≤0.4)
	Fonte ductile	Résistance à la traction ≤800MPa	MP8010	200 (80–300)	≤0.03DC	≤DC	0.3 (≤0.4)
H	Acier traité	45–55HRC	MP8010	100 (80–120)	≤0.01DC	≤DC	0.1 (≤0.2)
	Acier traité	55–65HRC	MP8010	70 (60–80)	≤0.01DC	≤DC	0.1 (≤0.2)

* Opérations de surfacage.

Remarque 1) Cette stratégie est recommandée lors de l'utilisation d'un corps acier. En cas de vibration ou d'écaillage de l'arête de coupe, diminuer les conditions de coupe comme l'engagement, la profondeur de passe et l'avance par dent.

Remarque 2) La vitesse de coupe est calculée au niveau du bord périphérique de l'outil. Calculer la vitesse de la broche de la manière suivante.
Vitesse de broche de l'outil de coupe $n(\text{tr}/\text{min}) = 1000 \times \text{vitesse de coupe } V_c \div \text{diamètre de l'outil de coupe } DC \div 3,14$

Remarque 3) Noter ce qui suit lors de l'usinage d'aciers trempés avec la nuance MP8010.

- Réduire autant que possible le porte-à-faux.
- L'utilisation d'un corps carbure est recommandée.
- Vérifier la profondeur de passe pour éviter l'écaillage de l'arête.

FRAISES À PLAQUETTES

FRAISE HEMISPHERIQUE



SRM2



K

FRAISES À PLAQUETTES



● Série standard

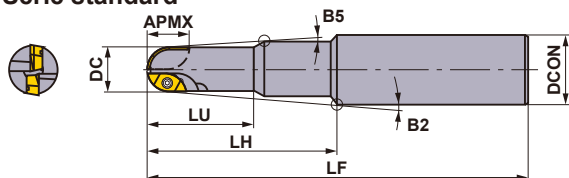

● Coupe longue

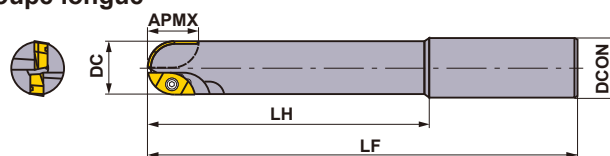

● Fraise longue

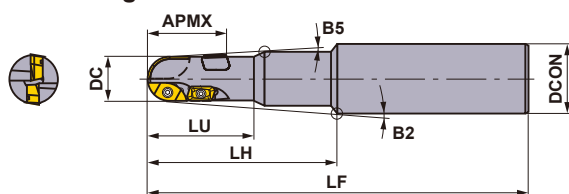

● Série longue

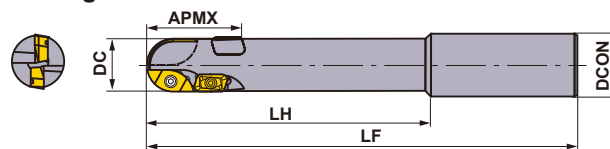

● Série extra longue détalonnée

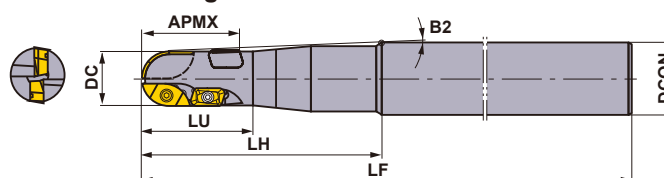









Outil à droite uniquement.

Type	Référence	Stock R	Trou d'arrosage	Nombre de dents	Dimensions (mm)							*1 Intérieure, Extérieure	*1 En périphérie	① Intérieure, Extérieure	② En périphérie	③	Plaque	Plaque	Plaque	
					RE	DC	DCON	LF	LH	LU	APMX									B2
Standard	SRM2160SNM	★	—	2	8	16	20	130	50	25	12	2.8°	1.5°	TS25H	—	①TKY08D	—	SRG16C	SRG16E	—
	SRM2160SAM	●	○	2	8	16	20	130	50	25	12	2.8°	1.5°	TS25H	—	①TKY08D	—	SRM16C-M	SRM16E-M	—
	SRM2200SNM	★	—	2	10	20	25	150	70	35	14	2.45°	1.5°	TS32	—	①TKY08D	—	SRG20C	SRG20E	—
	SRM2200SAM	●	○	2	10	20	25	150	70	35	14	2.45°	1.5°	TS32	—	①TKY08D	—	SRM20C-M	SRM20E-M	—
	SRM2250SNM	★	—	2	12.5	25	32	180	80	40	19	3.22°	1.5°	TS43	—	②TKY15T	—	SRG25C	SRG25E	—
	SRM2250SAM	●	○	2	12.5	25	32	180	80	40	19	3.22°	1.5°	TS43	—	②TKY15T	—	SRM25C-M	SRM25E-M	—
	SRM2300SNM	★	—	2	15	30	32	200	100	50	24	0.73°	0.5°	TS55	—	②TKY25T	—	SRG30C	SRG30E	—
	SRM2300SAM	●	○	2	15	30	32	200	100	50	24	0.73°	0.5°	TS55	—	②TKY25T	—	SRM30C-M	SRM30E-M	—
	SRM2320SAM	●	—	2	16	32	32	200	100	45	28	0.5°	0.5°	TS55	—	②TKY25T	—	SRG32C	SRG32E	—

*1 Couple de serrage (N • m) : TS25H=1,7, TS25=1,0, TS32=2,0, TS43=3,5, TS55=7,5

*2 RE est défini par le rayon de plaque R.

● : Article stocké. ★ : Article standard Japon.

Type	Référence	Stock R	Trou d'arrosage	Nombre de dents	Dimensions (mm)							*1 	*1 	① 	② 	③ 					
					*2	DC	DCON	LF	LH	LU	APMX									B2	B5
					RE	RE	RE	RE	RE	RE	RE									RE	RE
Série longue	SRM2200SNL	★	—	4	10	20	25	150	70	35	30	2.45°	1.5°	TS32	TS25	①TKY08D	①TKY08D	SRG20C SRM20C-M	SRG20E SRM20E-M	APMT1135 PDER-②	
	SRM2200SAL	●	○	4	10	20	25	150	70	35	30	2.45°	1.5°	TS32	TS25	①TKY08D	①TKY08D	SRG20C SRM20C-M	SRG20E SRM20E-M	APMT1135 PDER-②	
	SRM2250SNL	★	—	4	12.5	25	32	180	80	40	37	3.22°	1.5°	TS43	TS25	②TKY15T	③TKY08F	SRG25C SRM25C-M	SRG25E SRM25E-M	APMT1135 PDER-②	
	SRM2250SAL	●	○	4	12.5	25	32	180	80	40	37	3.22°	1.5°	TS43	TS25	②TKY15T	③TKY08F	SRG25C SRM25C-M	SRG25E SRM25E-M	APMT1135 PDER-②	
	SRM2300SNL	★	—	4	15	30	32	200	100	50	44	0.73°	0.5°	TS55	TS43	②TKY25T	③TKY15F	SRG30C SRM30C-M	SRG30E SRM30E-M	APMT1604 PDER-②	
	SRM2300SAL	★	○	4	15	30	32	200	100	50	44	0.73°	0.5°	TS55	TS43	②TKY25T	③TKY15F	SRG30C SRM30C-M	SRG30E SRM30E-M	APMT1604 PDER-②	
	SRM2320SAL	●	—	4	16	32	32	200	100	60	44	0.5°	0.5°	TS55	TS43	②TKY25T	③TKY15F	SRG32C SRM32C-M	SRG32E SRM32E-M	APMT1604 PDER-②	
Coupe longue	SRM2160SNF	★	—	2	8	16	16	150	70	—	12	—	—	TS25H	—	①TKY08D	—	SRG16C SRM16C-M	SRG16E SRM16E-M	—	
	SRM2160SAF	★	○	2	8	16	16	150	70	—	12	—	—	TS25H	—	①TKY08D	—	SRG16C SRM16C-M	SRG16E SRM16E-M	—	
	SRM2200SNF	★	—	2	10	20	20	180	100	—	14	—	—	TS32	—	①TKY08D	—	SRG20C SRM20C-M	SRG20E SRM20E-M	—	
	SRM2200SAF	★	○	2	10	20	20	180	100	—	14	—	—	TS32	—	①TKY08D	—	SRG20C SRM20C-M	SRG20E SRM20E-M	—	
	SRM2250SNF	★	—	2	12.5	25	25	200	120	—	19	—	—	TS43	—	②TKY15T	—	SRG25C SRM25C-M	SRG25E SRM25E-M	—	
	SRM2250SAF	★	○	2	12.5	25	25	200	120	—	19	—	—	TS43	—	②TKY15T	—	SRG25C SRM25C-M	SRG25E SRM25E-M	—	
	SRM2300SNF	★	—	2	15	30	32	230	150	—	24	—	—	TS55	—	②TKY25T	—	SRG30C SRM30C-M	SRG30E SRM30E-M	—	
	SRM2300SAF	★	○	2	15	30	32	230	150	—	24	—	—	TS55	—	②TKY25T	—	SRG30C SRM30C-M	SRG30E SRM30E-M	—	
Série longue	SRM2200SNLF	★	—	4	10	20	20	180	100	—	30	—	—	TS32	TS25	①TKY08D	①TKY08D	SRG20C SRM20C-M	SRG20E SRM20E-M	APMT1135 PDER-②	
	SRM2200SALF	★	○	4	10	20	20	180	100	—	30	—	—	TS32	TS25	①TKY08D	①TKY08D	SRG20C SRM20C-M	SRG20E SRM20E-M	APMT1135 PDER-②	
	SRM2250SNLF	★	—	4	12.5	25	25	200	120	—	37	—	—	TS43	TS25	②TKY15T	③TKY08F	SRG25C SRM25C-M	SRG25E SRM25E-M	APMT1135 PDER-②	
	SRM2250SALF	★	○	4	12.5	25	25	200	120	—	37	—	—	TS43	TS25	②TKY15T	③TKY08F	SRG25C SRM25C-M	SRG25E SRM25E-M	APMT1135 PDER-②	
	SRM2300SNLF	★	—	4	15	30	32	230	150	—	44	—	—	TS55	TS43	②TKY25T	③TKY15F	SRG30C SRM30C-M	SRG30E SRM30E-M	APMT1604 PDER-②	
	SRM2300SALF	★	○	4	15	30	32	230	150	—	44	—	—	TS55	TS43	②TKY25T	③TKY15F	SRG30C SRM30C-M	SRG30E SRM30E-M	APMT1604 PDER-②	
Série extra longue détaillée	SRM2200SNLL	★	—	4	10	20	25	250	120	35	30	1.5°	—	TS32	TS25	①TKY08D	①TKY08D	SRG20C SRM20C-M	SRG20E SRM20E-M	APMT1135 PDER-②	
	SRM2200SALL	★	○	4	10	20	25	250	120	35	30	1.5°	—	TS32	TS25	①TKY08D	①TKY08D	SRG20C SRM20C-M	SRG20E SRM20E-M	APMT1135 PDER-②	
	SRM2250SNLL	★	—	4	12.5	25	32	300	170	37	37	1.5°	—	TS43	TS25	②TKY15T	③TKY08F	SRG25C SRM25C-M	SRG25E SRM25E-M	APMT1135 PDER-②	
	SRM2250SALL	★	○	4	12.5	25	32	300	170	37	37	1.5°	—	TS43	TS25	②TKY15T	③TKY08F	SRG25C SRM25C-M	SRG25E SRM25E-M	APMT1135 PDER-②	
	SRM2300SNLL	★	—	4	15	30	32	350	100	50	44	1.5°	—	TS55	TS43	③TKY25T	③TKY15F	SRG30C SRM30C-M	SRG30E SRM30E-M	APMT1604 PDER-②	
	SRM2300SALL	★	○	4	15	30	32	350	100	50	44	1.5°	—	TS55	TS43	③TKY25T	③TKY15F	SRG30C SRM30C-M	SRG30E SRM30E-M	APMT1604 PDER-②	

*1 Couple de serrage (N • m) : TS25H=1,7, TS25=1,0, TS32=2,0, TS43=3,5, TS55=7,5

*2 RE est défini par le rayon de plaquette R.

FRAISES À PLAQUETTES

K

FRAISES À PLAQUETTES



● Série standard

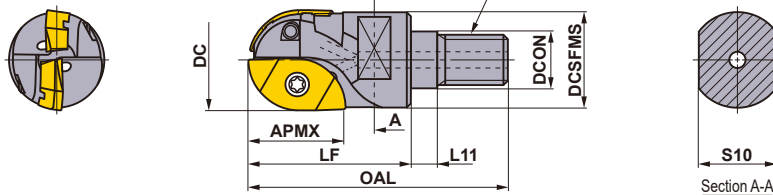

● Fraise longue

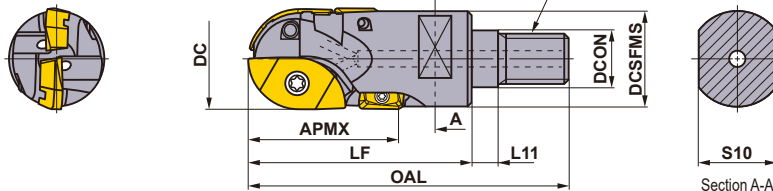

■ FRAISE À EMBOUT FILETÉ

Outil à droite uniquement.

Type	Référence	Stock R	Trou d'arrosage	Dimensions (mm)									*3 WT (kg)	*1			Clé	Plaquette		
				RE	DC	DCON	DCSFMS	OAL	LF	L11	S10	CRKS		APMX	Intérieure, Extérieure	En périphérie		Vis de fixation	Intérieure	Extérieure
Standard	SRM2160AM08S30	●	○	8	16	8.5	14.6	48	30	6	10	M8	12	0.1	TS25H	—	①TKY08D	SRG16C SRM16C-M	SRG16E SRM16E-M	—
	SRM2200AM10S35	●	○	10	20	10.5	18.6	54	35	6	14	M10	14	0.1	TS32	—	①TKY08D	SRG20C SRM20C-M	SRG20E SRM20E-M	—
	SRM2250AM12S40	●	○	12.5	25	12.5	23.5	62	40	6	19	M12	19	0.2	TS43	—	②TKY15T	SRG25C SRM25C-M	SRG25E SRM25E-M	—
	SRM2300AM16S45	★	○	15	30	17	28.3	68	45	6	24	M16	24	0.2	TS55	—	②TKY25T	SRG30C SRM30C-M	SRG30E SRM30E-M	—
	SRM2320AM16S45	●	○	16	32	17	30.0	68	45	6	24	M16	28	0.2	TS55	—	②TKY25T	SRG32C SRM32C-M	SRG32E SRM32E-M	—
Série longue	SRM2200AM10L45	★	○	10	20	10.5	18.6	64	45	6	14	M10	30	0.2	TS32	TS25	①TKY08D	SRG20C SRM20C-M	SRG20E SRM20E-M	APMT1135 PDER-2
	SRM2200M10L	□	—	10	20	10.5	18.6	66	47	6	15	M10	30	0.2	TS32	TS25	①TKY08D	SRG20C SRM20C-M	SRG20E SRM20E-M	APMT1135 PDER-2
	SRM2250AM12L55	★	○	12.5	25	12.5	23.5	77	55	6	19	M12	37	0.3	TS43	TS25	②TKY15T ③TKY08F	SRG25C SRM25C-M	SRG25E SRM25E-M	APMT1135 PDER-2
	SRM2250M12L	□	—	12.5	25	12.5	23.5	77	55	6	17	M12	37	0.3	TS43	TS25	②TKY15T ③TKY08F	SRG25C SRM25C-M	SRG25E SRM25E-M	APMT1135 PDER-2
	SRM2300AM16L60	★	○	15	30	17	28.3	83	60	6	24	M16	44	0.3	TS55	TS43	②TKY25T ③TKY15F	SRG30C SRM30C-M	SRG30E SRM30E-M	APMT1604 PDER-2
	SRM2300M16L	□	—	15	30	17	28.3	86	63	6	22	M16	44	0.3	TS55	TS43	②TKY15T ③TKY08F	SRG30C SRM30C-M	SRG30E SRM30E-M	APMT1604 PDER-2
	SRM2320AM16L60	★	○	16	32	17	29.0	83	60	6	24	M16	44	0.3	TS55	TS43	②TKY25T ③TKY15F	SRG32C SRM32C-M	SRG32E SRM32E-M	APMT1604 PDER-2
SRM2320M16L	□	—	16	32	17	29.0	86	63	6	22	M16	44	0.3	TS55	TS43	②TKY15T ③TKY08F	SRG32C SRM32C-M	SRG32E SRM32E-M	APMT1604 PDER-2	

Remarque 1) Pour les arbres vissables, veuillez vous référer à la page K244.

*1 Couple de serrage (N • m) : TS25H=1,7, TS25=1,0, TS32=2,0, TS43=3,5, TS55=7,5

*2 RE est défini par le rayon de plaquette R.

*3 WT : Poids de l'outil

● : Article stocké. ★ : Article standard Japon.

□ : Article non stocké - Fabrication sur commande uniquement. (10 plaquettes par boîte)

PLAQUETTES

Type	Forme	Référence	Classe	Revêtu				Dimensions (mm)							Géométrie	
				F7030	MP6120	MP9120	VP15TF	RE	L	LE	W1	S	BS	AN		B9
				Conditions de coupe :												
Matière				P Acier M Acier Inoxydable K Fonte S Alliage réfractaire, Alliage titane H Acier trempé				● : Coupe Stable ● : Coupe Générale ✚ : Coupe Instable								
Intérieure		SRG16C	G	●	★	●	8	16	—	8.2	3.5	—	11°	—		
		SRG20C	G	●	★	●	10	19	—	10.2	4.6	—	10°	18°		
		SRG25C	G	●	★	●	12.5	24	—	12.8	5.5	—	10°	18°		
		SRG30C	G	●	★	●	15	28	—	15.3	7	—	10°	18°		
		SRG32C	G	●	★	●	16	28	—	16.3	7	—	10°	18°		
Extérieure		SRG16E	G	●	★	●	8	13.5	—	6.7	3.5	—	11°	—		
		SRG20E	G	●	★	●	10	15.5	—	8.5	4.6	—	9°	—		
		SRG25E	G	●	★	●	12.5	20.5	—	10.2	5.5	—	9°	—		
		SRG30E	G	●	★	●	15	25.2	—	12.2	7	—	9°	—		
		SRG32E	G	●	★	●	16	26.1	—	13.1	7	—	9°	—		
Intérieure		SRM16C-M	M	●	★	●	8	16	—	8.2	3.5	—	11°	—		
		SRM20C-M	M	●	★	●	10	19	—	10.2	4.6	—	10°	18°		
		SRM25C-M	M	●	★	●	12.5	24	—	12.8	5.5	—	10°	18°		
		SRM30C-M	M	●	★	●	15	28	—	15.3	7	—	10°	18°		
		SRM32C-M	M	●	★	●	16	28	—	16.3	7	—	10°	18°		
Extérieure		SRM16E-M	M	●	★	●	8	13.5	—	6.7	3.5	—	11°	—		
		SRM20E-M	M	●	★	●	10	15.5	—	8.5	4.6	—	9°	—		
		SRM25E-M	M	●	★	●	12.5	20.5	—	10.2	5.5	—	9°	—		
		SRM30E-M	M	●	★	●	15	25.2	—	12.2	7	—	9°	—		
		SRM32E-M	M	●	★	●	16	26.1	—	13.1	7	—	9°	—		
En périphérie		APMT1135PDER-H2	M	●		●	0.8	11.25	9	6.35	3.5	1.2	11°	—		
		APMT1604PDER-H2	M	●		●	0.8	17.11	14	9.525	4.76	1.4	11°	—		
*1		APMT1135PDER-M2	M	●		●	0.8	11.18	9	6.35	3.5	1.2	11°	—		
		APMT1604PDER-M2	M	●		●	0.8	17.10	14	9.525	4.76	1.4	11°	—		

(Les plaquettes intérieures et extérieures à faible effort de coupe appartiennent à la classe de précision type M.)

*1 Sélection pour les arêtes de coupe périphériques : la première recommandation est le brise-copeaux de type M (APMT....PDER-M2) pour son importante acuité. Lorsque le renfort d'arête est particulièrement important, veuillez utiliser le brise-copeaux H (APMT....PDER-H2).

K

FRAISES À PLAQUETTES

CONDITIONS DE COUPE RECOMMANDÉES

SRM2 $\varnothing 16 - \varnothing 32$

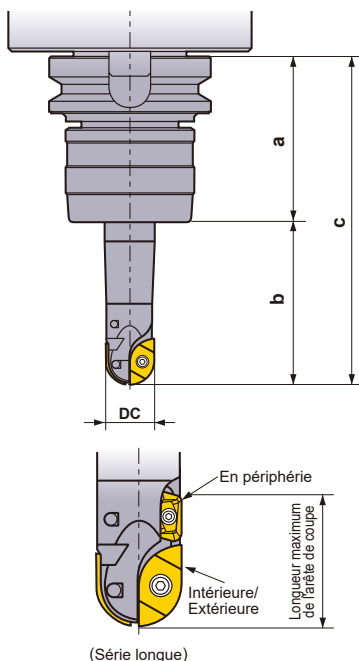

FRAISES À PLAQUETTES

K

Porte-à-faux

Les conditions de coupe recommandées sont basées sur le débattement de l'outil, les vibrations, et la surface d'usinage en utilisant un attachement BT50, avec les conditions ci-dessous : "a", la hauteur du nez de broche à la face de l'attachement. "b", longueur utile (la longueur du porte-à-faux du bout de l'outil à la face de l'attachement).

Diamètre de l'arête de coupe:DC	Type	a	b	c
16	Standard	105	50	155
	Coupe Longue		70	175
	Extra Longue		—	—
20	Standard		70	175
	Coupe Longue		100	205
	Extra Longue		150	255
25	Standard		80	185
	Coupe Longue		120	225
	Extra Longue		200	305
30	Standard		100	205
	Coupe Longue	150	255	
	Extra Longue	250	355	

Profondeur de passe pour les fraise de série longue

La longueur maximum de l'arête de coupe sur une fraise de type "coupe longue" avec une plaquette périphérique est de 1.4-1.5DC. La plaquette périphérique est utilisée seulement pour enlever la matière non usinée de la face supérieure. Se reporter aux conditions de coupe recommandées pour la profondeur de passe ap.

Tolérances d'outil avec plaquettes montées

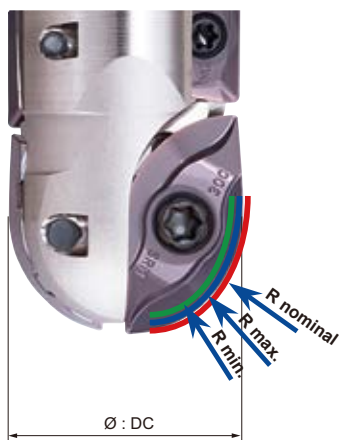

Tolérance radiale

Diamètre de l'arête de coupe DC	R nominal	Tolérance	R min.	R max.
16	8	G	7.925	7.975
		M	7.910	7.970
20	10	G	9.925	9.975
		M	9.910	9.970
25	12.5	G	12.425	12.475
		M	12.410	12.470
30	15	G	14.925	14.975
		M	14.910	14.970

Dimensions avec plaquettes montées

Diamètre de l'arête de coupe DC	Tolérance	DC min.	DC max.
16	G	15.800	16.000
	M	15.770	15.990
20	G	19.800	20.000
	M	19.770	19.990
25	G	24.800	25.000
	M	24.770	24.990
30	G	29.800	30.000
	M	29.770	29.990

*M : classe de précision M

RAINURAGE

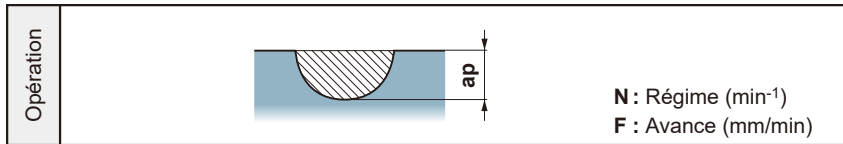

Matière	Dureté	Vitesse de coupe (m/min)	Nuance	Type attachement	φ16			φ20			φ25			φ30			
					N	F	ap	N	F	ap	N	F	ap	N	F	ap	
P Acier carbone Acier allié	180–280HB	160 (120–200)	MP6120 VP15TF Faible effort de coupe	Standard	3183	382	6	2546	306	8	2037	489	12.5	1698	407	15	
				Coupe Longue	3183	382	4	2546	306	4	2037	489	6	1698	407	7.5	
				Extra Longue	—	—	—	2546	306	2	2037	489	4	1698	407	3	
	280–350HB	140 (120–160)	MP6120 VP15TF Faible effort de coupe	Standard	2785	334	6	2228	267	8	1783	428	12.5	1485	357	15	
				Coupe Longue	2785	334	4	2228	267	4	1783	428	6	1485	357	7.5	
				Extra Longue	—	—	—	2228	267	2	1783	428	4	1485	357	3	
	Acier prétraité	35–45HRC	120 (100–160)	MP6120 VP15TF Faible effort de coupe	Standard	2387	286	6	1910	229	8	1528	367	12.5	1273	306	15
					Coupe Longue	2387	286	4	1910	229	4	1528	367	6	1273	306	7.5
					Extra Longue	—	—	—	1910	229	2	1528	367	4	1273	306	3
	Acier outil	≤350HB	140 (120–160)	MP6120 VP15TF Faible effort de coupe	Standard	2785	334	6	2228	267	8	1783	535	10	1485	594	12
					Coupe Longue	2785	334	4	2228	267	4	1783	535	5	1485	594	4.5
					Extra Longue	—	—	—	2228	267	2	1783	535	2.5	1485	594	1.5
M Acier inoxydable	≤270HB	200 (100–250)	VP15TF Faible effort de coupe	Standard	3979	477	4	3183	382	5	2546	764	6	2122	849	7.5	
				Coupe Longue	3979	477	3	3183	382	3	2546	611	4	2122	637	4.5	
				Extra Longue	—	—	—	3183	382	1.5	2546	509	1.5	2122	509	1.5	
K Fonte grise	≤350MPa	200 (150–300)	VP15TF Faible effort de coupe	Standard	3979	796	6	3183	637	8	2546	1019	12.5	2122	849	15	
				Coupe Longue	3979	796	4	3183	637	4	2546	1019	7.5	2122	849	4.5	
				Extra Longue	—	—	—	3183	637	2	2546	1019	4	2122	849	3	
	Fonte ductile	≤500MPa	180 (150–240)	VP15TF Faible effort de coupe	Standard	3581	716	6	2865	573	8	2292	917	12.5	1910	764	15
					Coupe Longue	3581	716	4	2865	573	4	2292	917	7.5	1910	764	4.5
					Extra Longue	—	—	—	2865	573	2	2292	917	4	1910	764	1.5
	Fonte ductile	≤800MPa	160 (150–250)	VP15TF Faible effort de coupe	Standard	3183	637	6	2546	509	8	2037	815	12.5	1698	679	15
					Coupe Longue	3183	637	4	2546	509	4	2037	815	7.5	1698	679	4.5
					Extra Longue	—	—	—	2546	509	2	2037	815	4	1698	679	1.5
H Acier traité	45–50HRC	100 (60–120)	VP15TF Arête de coupe renforcée	Standard	1989	239	4	1591	191	4	1273	255	6	1061	212	7.5	
				Coupe Longue	1989	239	2	1591	191	2	1273	255	4	1061	212	3	
				Extra Longue	—	—	—	1591	191	1	1273	255	2.5	1061	212	1.5	
	Acier traité	50–60HRC	60 (40–100)	VP15TF Arête de coupe renforcée	Standard	1194	143	4	955	115	4	764	153	6	637	127	7.5
					Coupe Longue	1194	143	2	955	115	2	764	153	4	637	127	3
					Extra Longue	—	—	—	955	115	1	764	153	2.5	637	127	1.5
S Alliage titane	≤350HB	50 (30–60)	MP9120	Standard	995	100	4	796	80	4	637	64	6	531	53	7.5	
				Coupe Longue	995	100	2	796	80	2	637	64	4	531	53	3	
				Extra Longue	—	—	—	796	80	1	637	64	2.5	531	53	1.5	
	Alliage réfractaire	—	40 (30–60)	MP9120	Standard	796	80	4	637	64	4	510	51	6	425	43	7.5
					Coupe Longue	796	80	2	637	64	2	510	51	4	425	43	3
					Extra Longue	—	—	—	637	64	1	510	51	2.5	425	43	1.5

K

FRAISES À PLAQUETTES

FRAISES À PLAQUETTES

CONDITIONS DE COUPE RECOMMANDÉES

■ SURFACER-DRESSER (Prof. de passe : Petit)

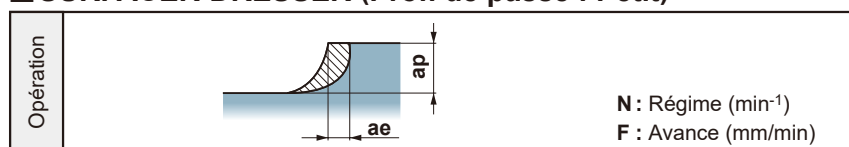

K

FRAISES À PLAQUETTES

Opération	Matière	Dureté	Vitesse de coupe (m/min)	Nuance	Type attachement	φ16				φ20				φ25				φ30			
						N	F	ap	ae	N	F	ap	ae	N	F	ap	ae	N	F	ap	ae
P	Acier carbone Acier allié	180-280HB	200 (160-250)	MP6120 VP15TF Faible effort de coupe	Standard	3979	796	4	6	3183	955	5	8	2546	1273	6	10	2122	1273	7.5	10
					Coupe Longue	3979	637	4	4	3183	637	5	6	2546	1273	6	7.5	2122	1273	7.5	7.5
					Extra Longue	—	—	—	—	3183	382	5	4	2546	1019	6	5	2122	637	7.5	3
		280-350HB	160 (120-200)	MP6120 VP15TF Faible effort de coupe	Standard	3183	509	4	6	2546	509	5	8	2037	815	6	10	1698	849	7.5	10
					Coupe Longue	3183	382	4	4	2546	407	5	6	2037	611	6	7.5	1698	509	7.5	7.5
					Extra Longue	—	—	—	—	2546	306	5	4	2037	489	6	5	1698	407	7.5	3
	Acier prétraité	35-45HRC	160 (120-200)	MP6120 VP15TF Faible effort de coupe	Standard	3183	509	4	6	2546	509	5	8	2037	815	6	10	1698	849	7.5	10
					Coupe Longue	3183	382	4	4	2546	407	5	6	2037	611	6	7.5	1698	679	7.5	7.5
					Extra Longue	—	—	—	—	2546	306	5	4	2037	489	6	5	1698	509	7.5	3
	Acier outil	≤350HB	160 (120-200)	MP6120 VP15TF Faible effort de coupe	Standard	3183	509	4	6	2546	509	5	8	2037	815	6	10	1698	849	7.5	10
					Coupe Longue	3183	382	4	4	2546	407	5	6	2037	611	6	7.5	1698	509	7.5	7.5
					Extra Longue	—	—	—	—	2546	306	5	4	2037	489	6	2.5	1698	407	7.5	1.5
M	Acier inoxydable	≤270HB	200 (100-250)	VP15TF Faible effort de coupe	Standard	3979	477	4	6	3183	509	5	8	2546	764	6	10	2122	849	7.5	10
					Coupe Longue	3979	477	4	4	3183	382	5	6	2546	611	6	7.5	2122	849	7.5	7.5
					Extra Longue	—	—	—	—	3183	382	5	4	2546	509	6	5	2122	424	7.5	1.5
K	Fonte grise	≤350MPa	200 (150-300)	VP15TF Faible effort de coupe	Standard	3979	1592	4	8	3183	1592	5	10	2546	1528	6	10	2122	1485	7.5	10
					Coupe Longue	3979	1194	4	6	3183	1273	5	8	2546	1528	6	10	2122	1485	7.5	6
					Extra Longue	—	—	—	—	3183	955	5	6	2546	1273	6	7.5	2122	1061	7.5	3
	Fonte ductile	≤500MPa	200 (150-280)	VP15TF Faible effort de coupe	Standard	3979	1592	4	8	3183	1592	5	10	2546	1528	6	10	2122	1273	7.5	10
					Coupe Longue	3979	1194	4	6	3183	1273	5	8	2546	1528	6	10	2122	1273	7.5	6
					Extra Longue	—	—	—	—	3183	955	5	6	2546	1273	6	7.5	2122	1061	7.5	3
	Fonte ductile	≤800MPa	180 (150-250)	VP15TF Faible effort de coupe	Standard	3581	1432	4	8	2865	1433	5	10	2292	1375	6	10	1910	1146	7.5	10
					Coupe Longue	3581	1074	4	6	2865	1146	5	8	2292	1375	6	10	1910	1146	7.5	6
					Extra Longue	—	—	—	—	2865	860	5	6	2292	1146	6	7.5	1910	955	7.5	3
H	Acier traité	45-50HRC	100 (60-120)	VP15TF Arête de coupe renforcée	Standard	1989	239	4	4	1591	191	5	5	1273	255	6	7.5	1061	212	7.5	3
					Coupe Longue	1989	239	4	2	1591	191	5	3	1273	255	6	4	1061	212	7.5	1.5
					Extra Longue	—	—	—	—	1591	191	5	2	1273	204	6	1.5	1061	170	7.5	1
	Acier traité	50-60HRC	60 (40-100)	VP15TF Arête de coupe renforcée	Standard	1194	143	4	4	955	115	5	5	764	153	6	7.5	637	127	7.5	3
					Coupe Longue	1194	143	4	2	955	115	5	3	764	153	6	4	637	127	7.5	1.5
					Extra Longue	—	—	—	—	955	115	5	2	764	122	6	1.5	637	102	7.5	1
S	Alliage titane	≤350HB	50 (30-60)	MP9120	Standard	995	299	4	4	796	239	4	5	637	191	6	7.5	531	159	7.5	3
					Coupe Longue	995	299	2	2	796	239	2	3	637	191	4	4	531	159	3	1.5
					Extra Longue	—	—	—	—	796	239	1	2	637	191	2.5	1.5	531	159	1.5	1
	Alliage réfractaire	—	40 (30-60)	MP9120	Standard	796	239	4	4	637	191	4	5	510	153	6	7.5	425	128	7.5	3
					Coupe Longue	796	239	2	2	637	191	2	3	510	153	4	4	425	128	3	1.5
					Extra Longue	—	—	—	—	637	191	1	2	510	153	2.5	1.5	425	128	1.5	1

■ SURFACER-DRESSER (Prof. de passe : Large)

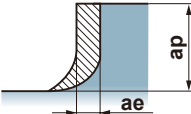
Opération		N : Régime (min ⁻¹) F : Avance (mm/min)

Remarque: Usinage aciers inoxydables

En fraisage en opposition d'aciers inoxydables avec de grandes et larges profondeurs de coupe, la surface usinée est sujette aux bavures et à l'arête rapportée à cause du bourrage copeaux. Pour les aciers inoxydables, le fraisage en avalant est recommandé.

Matière	Dureté	Vitesse de coupe (m/min)	Nuance	Type attachement	φ16				φ20				φ25				φ30				
					N	F	ap	ae	N	F	ap	ae	N	F	ap	ae	N	F	ap	ae	
P Acier carbone Acier allié	180-280HB	200 (160-250)	MP6120 VP15TF Faible effort de coupe	Standard	3979	637	8	4	3183	764	10	4	2546	1273	12.5	5	2122	1273	15	4.5	
				Coupe Longue	3979	477	8	3	3183	509	10	3	2546	1019	12.5	4	2122	849	15	3	
				Extra Longue	—	—	—	—	3183	382	10	2	2546	764	12.5	2.5	2122	849	15	1.5	
	280-350HB	160 (120-200)	MP6120 VP15TF Faible effort de coupe	Standard	3183	382	8	4	2546	509	10	4	2037	815	12.5	5	1698	849	15	4.5	
				Coupe Longue	3183	382	8	3	2546	306	10	3	2037	611	12.5	4	1698	509	15	3	
				Extra Longue	—	—	—	—	2546	306	10	2	2037	489	12.5	2.5	1698	407	15	1.5	
	Acier prétraité	35-45HRC	160 (120-200)	MP6120 VP15TF Faible effort de coupe	Standard	3183	382	8	4	2546	509	10	4	2037	815	12.5	5	1698	849	15	4.5
					Coupe Longue	3183	382	8	3	2546	306	10	3	2037	611	12.5	4	1698	509	15	3
					Extra Longue	—	—	—	—	2546	306	10	2	2037	489	12.5	2.5	1698	407	15	1.5
	Acier outil	≤350HB	160 (120-200)	MP6120 VP15TF Faible effort de coupe	Standard	3183	382	8	4	2546	509	10	4	2037	815	12.5	5	1698	849	15	4.5
					Coupe Longue	3183	382	8	3	2546	306	10	3	2037	611	12.5	2.5	1698	509	15	3
					Extra Longue	—	—	—	—	2546	306	10	2	2037	489	12.5	1.5	1698	407	15	1.5
M Acier inoxydable	≤270HB	200 (100-250)	VP15TF Faible effort de coupe	Standard	3979	477	8	4	3183	509	10	4	2546	764	12.5	10	2122	849	15	10	
				Coupe Longue	3979	477	8	3	3183	382	10	3	2546	611	12.5	4	2122	509	15	4.5	
				Extra Longue	—	—	—	—	3183	382	10	2	2546	489	12.5	1.5	2122	340	15	1.5	
K Fonte grise	≤350MPa	200 (150-300)	VP15TF Faible effort de coupe	Standard	3979	1194	8	8	3183	1273	10	8	2546	1273	12.5	10	2122	1485	15	10	
				Coupe Longue	3979	955	8	5	3183	955	10	4	2546	1273	12.5	7.5	2122	1061	15	4.5	
				Extra Longue	—	—	—	—	3183	764	10	2	2546	1019	12.5	1.5	2122	849	15	3	
	Fonte ductile	≤500MPa	200 (150-280)	VP15TF Faible effort de coupe	Standard	3979	1194	8	8	3183	1273	10	8	2546	1273	12.5	10	2122	1273	15	10
					Coupe Longue	3979	955	8	5	3183	955	10	4	2546	1273	12.5	7.5	2122	849	15	4.5
					Extra Longue	—	—	—	—	3183	764	10	2	2546	1019	12.5	5	2122	849	15	1.5
	Fonte ductile	≤800MPa	180 (150-250)	VP15TF Faible effort de coupe	Standard	3581	1074	8	8	2865	1146	10	8	2292	1146	12.5	10	1910	1146	15	10
					Coupe Longue	3581	859	8	5	2865	860	10	4	2292	1146	12.5	7.5	1910	764	15	4.5
					Extra Longue	—	—	—	—	2865	688	10	2	2292	917	12.5	5	1910	764	15	1.5
H Acier traité	45-50HRC	100 (60-120)	VP15TF Arête de coupe renforcée	Standard	1989	239	8	2	1591	191	10	3	1273	255	12.5	4	1061	212	15	3	
				Coupe Longue	1989	239	8	1	1591	191	10	2	1273	204	12.5	1.5	1061	106	15	1.5	
				Extra Longue	—	—	—	—	1591	191	10	1	—	—	—	—	—	—	—	—	
	Acier traité	50-60HRC	60 (40-100)	VP15TF Arête de coupe renforcée	Standard	1194	143	8	2	955	115	10	3	764	153	12.5	4	637	127	15	3
					Coupe Longue	1194	143	8	1	955	115	10	2	764	122	12.5	1.5	637	64	15	1.5
					Extra Longue	—	—	—	—	955	115	10	1	—	—	—	—	—	—	—	—
S Alliage titane	≤350HB	50 (30-60)	MP9120	Standard	995	199	4	2	796	159	4	3	637	127	6	4	531	106	7.5	3	
				Coupe Longue	995	199	2	1	796	159	2	2	637	127	4	1.5	531	106	3	1.5	
				Extra Longue	—	—	—	—	796	159	1	1	637	127	2.5	—	531	106	1.5	—	
	Alliage réfractaire	—	40 (30-60)	MP9120	Standard	796	159	4	2	637	127	4	3	510	102	6	4	425	85	7.5	3
					Coupe Longue	796	159	2	1	637	127	2	2	510	102	4	1.5	425	85	3	1.5
					Extra Longue	—	—	—	—	637	127	1	1	510	102	2.5	—	425	85	1.5	—

K

FRAISES À PLAQUETTES

FRAISES À PLAQUETTES

FRAISE HEMISPHERIQUE



SRM2 $\varnothing 40$ $\varnothing 50$

P M **K** N S H

K

FRAISES À PLAQUETTES



● Attachement Weldon (Fig.1)

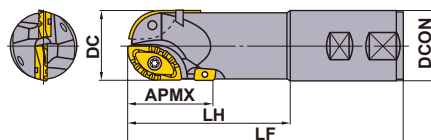

● Attachement Weldon (Fig.2)

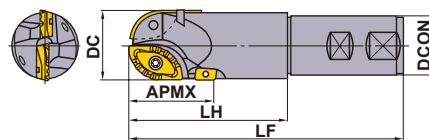

● Attachement Weldon (Fig.3)

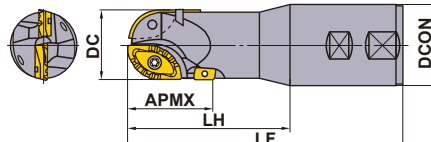

● Attachement Weldon (Fig.4)

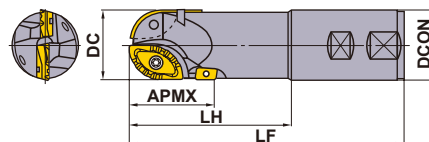

● Cône Morse (Fig.5)

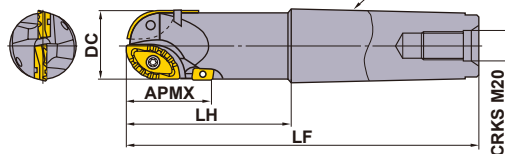

● Cône Morse (Fig.6)

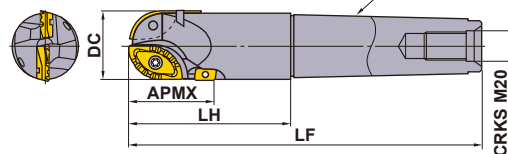

● Attachement combiné (Fig.7)

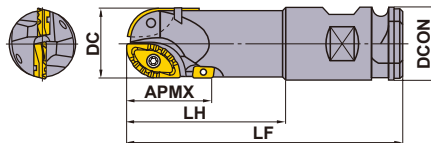

● Attachement cylindrique (Fig.8)

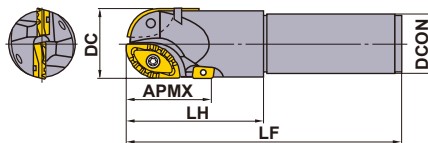

Outil à droite uniquement.





Type	Référence	Stock	Nombre de dents	Dimensions (mm)					Type (Fig.)	*1		*1		Intérieure	Extérieure	En périphérie		
				R	*2	DC	DCON	LF		LH	APMX	Vis de fixation	Clé				Plaque	Plaque
Attachement Weldon	Court	●	2	20	40	40	190	120	54	1	TS6S	TS43	TKY30T	TKY15F	SRG40C	SRG40E	APMT1604 PDER-02	
		□	2	20	40	50	200	120	54	3	TS6S	TS43	TKY30T	TKY15F	SRG40C	SRG40E	APMT1604 PDER-02	
	Moyen	●	2	25	50	40	190	120	63	2	TS6	TS43	TKY30T	TKY15F	SRG50C	SRG50E	APMT1604 PDER-02	
		□	2	25	50	50	200	120	63	4	TS6	TS43	TKY30T	TKY15F	SRG50C	SRG50E	APMT1604 PDER-02	
		□	2	20	40	40	220	150	54	1	TS6S	TS43	TKY30T	TKY15F	SRG40C	SRG40E	APMT1604 PDER-02	
		□	2	20	40	50	230	150	54	3	TS6S	TS43	TKY30T	TKY15F	SRG40C	SRG40E	APMT1604 PDER-02	
Cône Morse	Court	□	2	20	40	—	256	120	54	5	TS6S	TS43	TKY30T	TKY15F	SRG40C	SRG40E	APMT1604 PDER-02	
		★	2	25	50	—	256	120	63	6	TS6	TS43	TKY30T	TKY15F	SRG50C	SRG50E	APMT1604 PDER-02	
	Moyen	●	2	20	40	—	286	150	54	5	TS6S	TS43	TKY30T	TKY15F	SRG40C	SRG40E	APMT1604 PDER-02	
		★	2	25	50	—	286	150	63	6	TS6	TS43	TKY30T	TKY15F	SRG50C	SRG50E	APMT1604 PDER-02	
Attachement combiné	Court	★	2	20	40	50.8	200	120	54	7	TS6S	TS43	TKY30T	TKY15F	SRG40C	SRG40E	APMT1604 PDER-02	
		★	2	25	50	50.8	200	120	63	7	TS6	TS43	TKY30T	TKY15F	SRG50C	SRG50E	APMT1604 PDER-02	
	Moyen	★	2	20	40	50.8	250	170	54	7	TS6S	TS43	TKY30T	TKY15F	SRG40C	SRG40E	APMT1604 PDER-02	
		★	2	25	50	50.8	250	170	63	7	TS6	TS43	TKY30T	TKY15F	SRG50C	SRG50E	APMT1604 PDER-02	
		★	2	25	50	50.8	300	220	63	7	TS6	TS43	TKY30T	TKY15F	SRG50C	SRG50E	APMT1604 PDER-02	
		★	2	25	50	50.8	350	270	63	7	TS6	TS43	TKY30T	TKY15F	SRG50C	SRG50E	APMT1604 PDER-02	
Attachement cylindrique	Court	★	2	20	40	42	200	100	54	8	TS6S	TS43	TKY30T	TKY15F	SRG40C	SRG40E	APMT1604 PDER-02	
		★	2	25	50	42	200	100	63	8	TS6	TS43	TKY30T	TKY15F	SRG50C	SRG50E	APMT1604 PDER-02	
	Moyen	★	2	20	40	42	250	150	54	8	TS6S	TS43	TKY30T	TKY15F	SRG40C	SRG40E	APMT1604 PDER-02	
		★	2	25	50	42	250	100	63	8	TS6	TS43	TKY30T	TKY15F	SRG50C	SRG50E	APMT1604 PDER-02	

*1 Couple de serrage (N • m) : TS43=6,0, TS6=10,0, TS6S=10,0 *2 RE est défini par le rayon de plaque R.

● : Article stocké. ★ : Article standard Japon.

□ : Article non stocké - Fabrication sur commande uniquement. (10 plaquettes par boîte) (Les plaquettes signalée par (*2) sont conditionnées par 2 pièces.)

PLAQUETTES

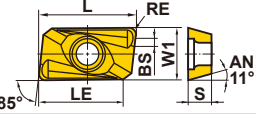
Matière		P	Acier	Conditions de coupe :											
		K	Fonte	●	●	●	●	● : Coupe Stable ● : Coupe Générale ✦ : Coupe Instable							
Type	Forme	Référence	Classe	Revêtu			Dimensions (mm)						Géométrie		
				F7030	VP15TF	VP20RT	VP30RT	RE	L	LE	W1	S		BS	AN
Intérieure		*2 SRG40C	G	●	●	●	●	20	36	—	20.5	8.0	—	11°	
		*2 SRG50C	G	●	●	●	●	25	40	—	26	8.5	—	11°	
Extérieure		*2 SRG40E	G	●	●	●	●	20	32	—	16.6	8.0	—	11°	
		*2 SRG50E	G	●	●	●	●	25	35.8	—	20	8.5	—	11°	
*1 En périphérie	Arête de coupe renforcée	APMT1604PDER-H2	M	●	●			0.8	11.71	14	9.525	4.76	1.4	11°	
	Faible effort de coupe	APMT1604PDER-M2	M	●	●			0.8	17.10	14	9.525	4.76	1.4	11°	

(Les plaquettes intérieures et extérieures à faible effort de coupe appartiennent à la classe de précision type M.)

*1 Sélection pour les arêtes de coupe périphériques : la première recommandation est le brise-copeaux de type M (APMT....PDER-M2) pour son importante acuité.

Lorsque le renfort d'arête est particulièrement important, veuillez utiliser le brise-copeaux H (APMT....PDER-H2).

CONDITIONS DE COUPE RECOMMANDÉES

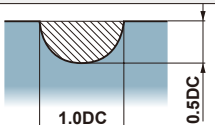
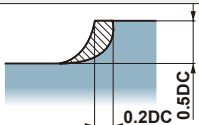
Mode de coupe	A : Rainurage	B : Surfacier-dresser (Série standard)	C : Surfacier-dresser (Fraise longue)
			

Matière	Dureté	Nuance	Vitesse de coupe (m/min)	Avance par dent (mm/dent)	Mode de coupe	
P	Acier outil	VP20RT VP30RT	160 (120–200)	0.12 (0.08–0.2)	A	
				0.2 (0.1–0.4)	B	
				0.15 (0.1–0.3)	C	
	Acier outil	VP20RT VP30RT	200 (160–250)	0.2 (0.1–0.3)	A	
				0.3 (0.1–0.4)	B	
				0.2 (0.1–0.4)	C	
	Acier moulé	≤235HB	VP20RT	200 (160–250)	0.2 (0.1–0.3)	A
					0.3 (0.1–0.4)	B
					0.2 (0.1–0.4)	C
	Acier moulé	≤230HB	VP15TF VP20RT	200 (160–300)	0.2 (0.1–0.3)	A
					0.3 (0.1–0.45)	B
					0.2 (0.1–0.4)	C
K	Fonte ductile	VP15TF VP20RT	200 (160–300)	0.25 (0.1–0.4)	A	
				0.35 (0.1–0.45)	B	
				0.25 (0.1–0.45)	C	
	Fonte	VP15TF VP20RT	200 (160–300)	0.25 (0.1–0.4)	A	
				0.35 (0.1–0.45)	B	
				0.25 (0.1–0.4)	C	

CHANFREINAGE

CESP/CFSP/CGSP

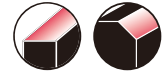

P M **K** N S H

K

FRAISES À PLAQUETTES

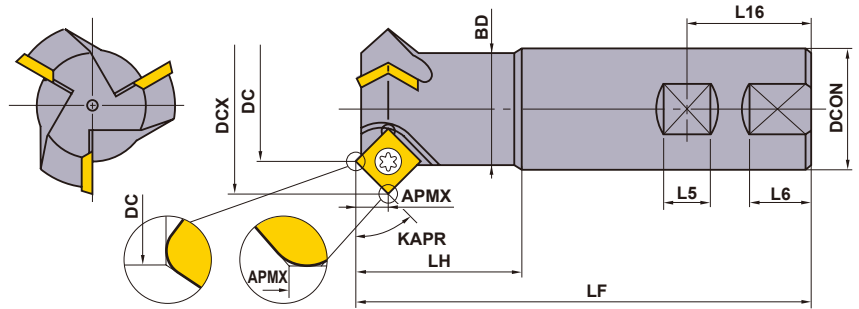

Outil à droite uniquement.

Référence	Stock	R	Nombre de dents	Dimensions (mm)										* Vis de fixation	① Clé	② Plaque
				KAPR	DC	DCX	LF	DCON	BD	LH	L16	L5	L6			
CESPR081S20	●	1	60°	8	19.6	110	20	19.5	40	25	11	—	10.2	TS52	①TKY25R	SPMW1203
CESPR161S20	●	1	60°	16	27.8	110	20	19.5	40	25	11	—	10.2	TS5	①TKY25R	SPMW1203
CESPR323S32	●	3	60°	32	43.8	125	32	31.5	45	36	14	19	10.2	TS5	①TKY25R	SPMW1203
CFSPR041S16S	●	1	45°	4	15.7	85	16	14.4	25	24	10	—	5.9	TS4	②TKY15F	SPMW0903
CFSPR041S16L	●	1	45°	4	15.7	110	16	14.4	50	24	10	—	5.9	TS4	②TKY15F	SPMW0903
CFSPR081S20	●	1	45°	8	24.6	110	20	19.5	40	25	11	—	8.3	TS5	①TKY25R	SPMW1203
CFSPR161S20	●	1	45°	16	32.6	110	20	19.5	40	25	11	—	8.3	TS5	①TKY25R	SPMW1203
CFSPR323S32	●	3	45°	32	48.6	125	32	31.5	45	36	14	19	8.3	TS5	①TKY25R	SPMW1203
CGSPR081S20	●	1	30°	8	28.4	110	20	19.5	40	25	11	—	5.9	TS5	①TKY25R	SPMW1203
CGSPR161S20	●	1	30°	16	36.4	110	20	19.5	40	25	11	—	5.9	TS5	①TKY25R	SPMW1203
CGSPR323S32	●	3	30°	32	52.4	125	32	31.5	45	36	14	19	5.9	TS5	①TKY25R	SPMW1203

* Couple de serrage (N • m) : TS4=3,5, TS5=7,5, TS52=7,5

● : Article stocké. ★ : Article standard Japon.
(10 plaquettes par boîte)

PLAQUETTES

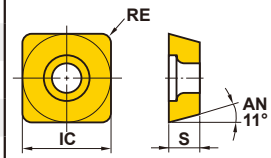
Matière	P	Acier											Conditions de coupe :			Géométrie	
	K	Fonte	●	●	●	●	●	●	●	●	●	●	●	●	●		●
Forme	Référence	Classe	Honing	Revêtu		Cermet		Carbure		Dimensions (mm)			Géométrie				
				VP15TF	UP20M	NX2525	NX4545	UTi20T	HTi10	IC	S	RE					
	SPMW090304	M	E*	★	●			●	●	●	●	9.525	3.18	0.4			
	SPMW090308	M	E*	★	●			★	★	●	●	9.525	3.18	0.8			
	SPMW120304	M	E*	★	●			●	●	●	●	12.7	3.18	0.4			
	SPMW120308	M	E*	★	●			●	●	●	●	12.7	3.18	0.8			

* Les plaquettes en nuances NX2525 et NX4545 ont une préparation "T" .

K

FRAISES À PLAQUETTES

CONDITIONS DE COUPE RECOMMANDÉES

Matière	Dureté	Nuance	Vitesse de coupe (m/min)	Avance par dent (mm/dent)	
				Chanfreinage	Surfaçage
P Acier carbone Alliage acier	180–280HB	UTi20T	80 (60–100)	0.4	0.15
		UP20M	130 (100–160)	0.4	0.2
		NX4545	130 (100–160)	0.4	0.2
	280–350HB	UTi20T	80 (60–100)	0.3	0.15
K Fonte	Résistance à la traction ≤450MPa	UTi20T	100 (85–120)	0.5	0.25
		HTi10	100 (85–120)	0.5	0.25

● Régime (min⁻¹) = (1000 × Vitesse de coupe) ÷ (3.14 × DC)

● Avance (mm/min) = Avance par dent × Nombre de dents × Régime de coupe

FRAISES À PLAQUETTES

RAINURAGE EN T



TSMP

- P
M
K
N
S
H

K

FRAISES À PLAQUETTES

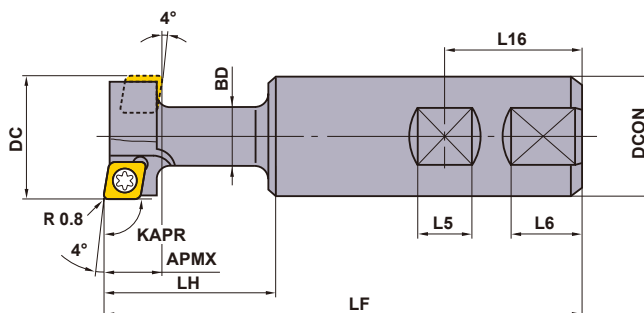
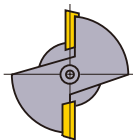

KAPR : 90°

Outil à droite uniquement.

Référence	Rainure en T Nomenclature	Stock R	Nombre de dents	Dimensions (mm)								* Vis de fixation	Clé	Plaquette	
				DC	LF	DCON	BD	LH	L16	L5	L6				APMX
TSMPR252S25	14	●	2	25	112	25	12.5	33.2	32	12	17	11	TS3	①TKY08D	MPMW070308
TSMPR322S32	18	●	2	32	120	32	16	41.2	36	14	19	14	TS4	②TKY15R	MPMW090308
TSMPR402S32	22	●	2	40	130	32	20	51.2	36	14	19	18	TS5	②TKY25R	MPMW120408

* Couple de serrage (N • m) : TS3=1,0, TS4=3,5, TS5=7,5

● : Article stocké.

(10 plaquettes par boîte)

PLAQUETTES

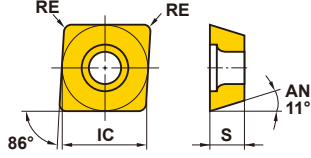
Matière	P	Acier	Carbure	Conditions de coupe :			Géométrie
	K	Fonte		● : Coupe Stable	● : Coupe Générale	⚡ : Coupe Instable	
Forme	Référence	Classe	UTi20T	Dimensions (mm)			Géométrie
				IC	S	RE	
	MPMW070308	M	●	7.94	3.18	0.8	
	MPMW090308	M	●	9.525	3.18	0.8	
	MPMW120408	M	●	12.7	4.76	0.8	

K

FRAISES À PLAQUETTES

CONDITIONS DE COUPE RECOMMANDÉES

Matière	Dureté	Nuance	Vitesse de coupe (m/min)	Avance (mm/tour)
P Acier carbone Alliage acier	180–280HB	UTi20T	130 (100–160)	0.15 (0.1–0.2)
	280–350HB	UTi20T	80 (60–100)	0.1 (0.05–0.15)
K Fonte	Résistance à la traction ≤450MPa	UTi20T	100 (80–120)	0.15 (0.1–0.2)

● Régime (min^{-1}) = $(1000 \times \text{Vitesse de coupe}) \div (3.14 \times \text{DC})$

PRÉCAUTIONS D'EMPLOI

- Lorsque vous usiner une rainure en T dans l'acier, la pièce doit être pré-usinée comme sur le schéma ci-contre, afin d'assurer une bonne évacuation copeaux.
- Les rainures en cours de réalisation ne doivent pas être encombrées par les copeaux. Évacuez ces derniers à l'aide d'air comprimé.

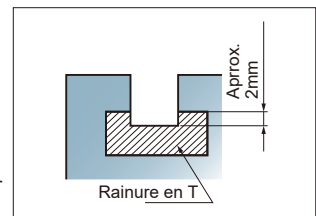

TRÉFLAGE



PMF

- P M **K** N S H

K

FRAISES À PLAQUETTES

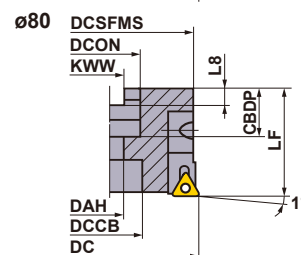
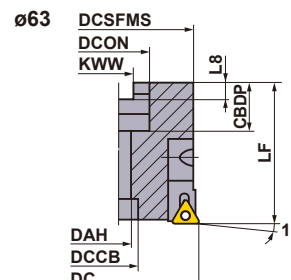
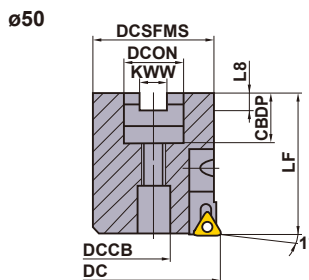

Outil à droite uniquement.

Référence	Stock	Nombre de dents	Dimensions (mm)										Cartouche	Vis de fixation *	Vis radiale	Vis de montage (Cartouche) *	Clé	Clé	Vis d'attachement	Plaquette
			DC	LF	DCON	CBBDP	DAH	DCCB	KWW	L8	DCSFMS									
PMF05004A22R	★	4	50	63	22	20	—	12	10.4	6.3	48	PMFA13R	TS254	TSS04005	HBH06012	TKY08F	HKY40R HKY50R	⓪HDS10031	TPEW 1303 ZP [®] R2	
PMF06306A22R	★	6	63	63	22	20	11	18	10.4	6.3	60	PMFA13R	TS254	TSS04005	HBH06012	TKY08F	HKY40R	⓪HSC10050		
PMF08008A27R	●	8	80	50	27	23	13.5	30	12.4	7	75	PMFA13R	TS254	TSS04005	HBH06012	TKY08F	HKY40R	⓪HSC12035		

* Couple de serrage (N • m) : TS254=1,0, HBH06012=8,5

PLAQUETTES

Matière	P	Acier	Conditions de coupe :				Dimensions (mm)				Géométrie
	K	Fonte	●	●	✚	IC	LE	S	BS		
Forme	Référence	Classe	Revêtu		CBN						
			VP15TF	AP10H		MB710					
	TPEW1303ZPER2	E	●	●		7.94	—	3.18	2		
	* TPEW1303ZPTR2	E			●	7.94	1.5	3.18	2		

● : Article stocké. ★ : Article standard Japon.

(10 plaquettes par boîte) (Les plaquettes CBN sont disponibles en 1 seule pièce dans un seul cas.)

CONDITIONS DE COUPE RECOMMANDÉES

Matière	Dureté	Nuance	Vitesse de coupe (m/min)	Avance par dent (mm/dent)	Matière	Dureté	Nuance	Vitesse de coupe (m/min)	Avance par dent (mm/dent)
P Acier carbone Alliage acier	180–280HB	VP15TF	250 (150–350)	0.1 (0.05–0.15)	K Fonte ductile	Résistance à la traction 360–500MPa	AP10H	250 (150–350)	0.1 (0.05–0.15)
	280–380HB	VP15TF	200 (100–300)				MB710	1000 (800–1200)	
K Fonte grise	Résistance à la traction ≤350MPa	AP10H	350 (200–500)	0.1 (0.05–0.15)	K Fonte ductile	Résistance à la traction 500–800MPa	AP10H	200 (100–300)	0.1 (0.05–0.15)
		MB710	1500 (1000–2000)				MB710	1000 (800–1200)	

● Régime (min^{-1}) = $(1000 \times \text{Vitesse de coupe}) \div (3.14 \times \text{DC})$

● Avance (mm/min) = Avance par dent \times Nombre de dents \times Régime de coupe

Remarque 1) Largeur de coupe recommandée : 0.1mm.

Remarque 2) L'usinage en montant et en descendant est recommandé pour une haute efficacité.

Remarque 3) En usinage transversal, l'avance par dent doit être de 0.05 (mm/dent) maximum.



PMR

- P M **K** N S H

FRAISES À PLAQUETTES

K

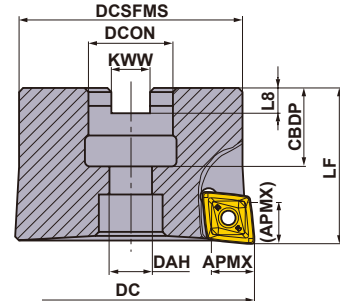

Outil à droite uniquement.

Type	Référence	Stock	R	Nombre de dents	Dimensions (mm)							Plaque		
					DC	LF	DCON	CBDP	DAH	DCSFMS	KWW		L8	APMX
Métrique	PMR405003A22R	★	3	3	50	40	22	20	11	45	10.4	6.3	11	CPMT1205ZPEN-M2/3
	PMR405203A22R	□	3	3	52	40	22	20	11	47	10.4	6.3	11	CPMT1205ZPEN-M2/3
	PMR406304A22R	★	4	4	63	40	22	20	11	57	10.4	6.3	11	CPMT1205ZPEN-M2/3
	PMR406604A27R	□	4	4	66	50	27	23	13	60	12.4	7	11	CPMT1205ZPEN-M2/3
Pouce	PMR405003BR	★	3	3	50	40	22.225	19	11	45	8.4	5	11	CPMT1205ZPEN-M2/3
	PMR406304BR	★	4	4	63	40	22.225	19	11	57	8.4	5	11	CPMT1205ZPEN-M2/3

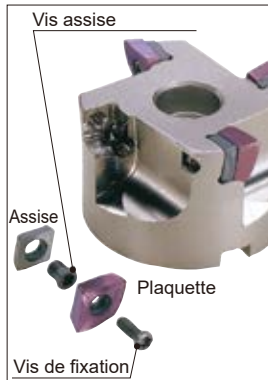

PIÈCES DÉTACHÉES

Référence porte-outil	Assise	Vis assise	Vis de fixation	Clé (Plaque)	Clé (Assise)	Vis de montage
PMR405003A22R	STPMR4N	WCS503507H	①TPS35	①TIP15T	HKY35R	HSC10035
PMR405203A22R	STPMR4N	WCS503507H	①TPS35	①TIP15T	HKY35R	HSC10035
PMR406304A22R	STPMR4N	WCS503507H	①TPS35	①TIP15T	HKY35R	HSC10035
PMR406604A22R	STPMR4N	WCS503507H	①TPS35	①TIP15T	HKY35R	HSC10035
PMR405003BR	STPMR4N	WCS503507H	①TPS35	①TIP15T	HKY35R	HSC10035
PMR406304BR	STPMR4N	WCS503507H	①TPS35	①TIP15T	HKY35R	HSC10035

* Couple de serrage (N • m) : TPS35=3,5, CSF401260T=5,0, WCS503507H=5,0, WCS604010H=7,0

● : Article stocké. ★ : Article standard Japon.

□ : Article non stocké - Fabrication sur commande uniquement. (10 plaquettes par boîte)

PLAQUETTES

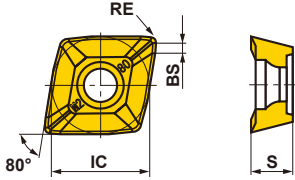
Matière	P	Acier	●									Conditions de coupe : ● : Coupe Stable ● : Coupe Générale ✦ : Coupe Instable
	K	Fonte										
Forme	Référence	Classe	Revêtu	Dimensions (mm)				Géométrie				
				IC	S	BS	RE					
	CPMT1205ZPEN-M2	M	●		12.7	5.56	1.4	0.8				
	CPMT1205ZPEN-M3	M	★		12.7	5.56	1.4	1.2				

K
FRAISES À PLAQUETTES

CONDITIONS DE COUPE RECOMMANDÉES

	Matière	Dureté	Nuance	Vitesse de coupe (m/min)	Avance par dent (mm/dent)	pf (mm)
P	Acier carbone Alliage acier	180–280HB	VP15TF	180 (150–200)	0.2 (0.1–0.3)	≤0.5DC
		280–380HB				
K	Fonte grise	Résistance à la traction ≤350MPa	VP15TF	180 (150–200)	0.2 (0.1–0.3)	≤0.5DC
		Résistance à la traction 360–500MPa				
	Fonte ductile	Résistance à la traction 500–800MPa	VP15TF	120 (100–150)	0.2 (0.1–0.3)	≤0.5DC

● Régime (min⁻¹)=(1000×Vitesse de coupe)÷(3.14×DC)

● Avance (mm/min)=Avance par dent×Nombre de dents×Régime de coupe

Remarque 1) Les conditions mentionnées ci-dessus sont recommandées pour les applications générales, il est toutefois possible d'utiliser des conditions d'usinage autres que celles mentionnées au tableau ci-dessus.

Remarque 2) En usinage horizontal, réduire l'avance de 20–40%.

Remarque 3) Si des vibrations interviennent lors de l'usinage, réduire la profondeur de passe et la vitesse de coupe de 20 à 50%.

FRAISES À PLAQUETTES

FRAISE À PLAQUETTES RONDES



ARP

- P
- M
- K
- N
- S
- H

K

FRAISES À PLAQUETTES



Fig.1

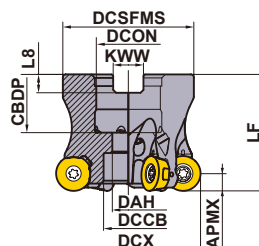
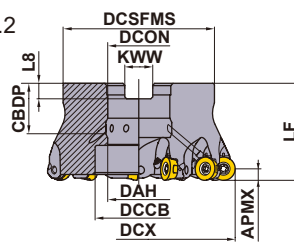

Fig.2



Corps standard à droite (R) uniquement

Diamètre fraise DCX (mm)	Vis d'attachement	Géométrie	
φ40	HSC08025H		
φ50, φ63	HSC10030H		
φ80	HSC12035H		
φ100	MBA16033H		

ATTACHEMENT PAR ALÉSAGE

GAMP: +4° GAMF: -6°

Type	Arête de coupe R (APMX)	Référence	Stock	Trou d'arrosage	Nombre de dents	Dimensions (mm)										WT* (kg)	Prof. de passe max. (mm)			RMPX	Fig.
						DCX	DCSFMS	LF	DCON	CBDP	DAH	DCCB	KWW	L8	APMX		A1	AZ			
Pas réduit	5	ARP5P-040A05AR	●	○	5	40	34	40	16	18	9	14	8.4	5.6	0.15	5.0	2.0	1.30	2.8°	1	
		ARP5P-042A05AR	●	○	5	42	34	40	16	18	9	14	8.4	5.6	0.16	5.0	2.5	1.4	2.8°	1	
		ARP5P-050A06AR	●	○	6	50	45	40	22	20	11	17	10.4	6.3	0.27	5.0	2.0	1.85	2.9°	1	
		ARP5P-052A06AR	●	○	6	52	45	40	22	20	11	17	10.4	6.3	0.29	5.0	2.5	2	3.0°	1	
		ARP5P-063A07AR	●	○	7	63	50	40	22	20	11	17	10.4	6.3	0.46	5.0	2.5	2.50	3.0°	1	
Pas extra fin	5	ARP5P-042A06AR	●	○	6	42	34	40	16	18	9	14	8.4	5.6	1.6	5.0	2.5	1.4	2.8°	1	
		ARP5P-050A07AR	●	○	7	50	45	40	22	20	11	17	10.4	6.3	0.27	5.0	2.0	1.85	2.9°	1	
		ARP5P-052A07AR	●	○	7	52	45	40	22	20	11	17	10.4	6.3	0.29	5.0	2.5	2	3.0°	1	
		ARP5P-063A08AR	●	○	8	63	50	40	22	20	11	17	10.4	6.3	0.46	5.0	2.5	2.50	3.0°	1	
Pas réduit	6	ARP6P-040A04AR	●	○	4	40	34	40	16	18	9	13.4	8.4	5.6	0.15	6.0	2.0	1.15	2.7°	1	
		ARP6P-050A05AR	●	○	5	50	45	40	22	20	11	17	10.4	6.3	0.26	6.0	2.0	1.70	2.9°	1	
		ARP6P-052A05AR	●	○	5	52	45	40	22	20	11	17	10.4	6.3	0.28	6.0	2.5	1.8	2.9°	1	
		ARP6P-063A06AR	●	○	6	63	50	40	22	20	11	17	10.4	6.3	0.44	6.0	2.5	2.50	3.1°	1	
		ARP6P-066X06AR	●	○	6	66	56	50	27	23	13	20	12.4	7	0.64	6.0	2.5	2.5	2.9°	1	
		ARP6P-080A08AR	●	○	8	80	56	50	27	23	13	20	12.4	7	0.88	6.0	2.5	2.50	2.3°	1	
		ARP6P-100B09AR	●	○	9	100	78	50	32	26	32	45	14.4	8	1.47	6.0	2.5	2.50	1.7°	2	
Pas extra fin	6	ARP6P-050A06AR	●	○	6	50	45	40	22	20	11	17	10.4	6.3	0.25	6.0	2.0	1.70	2.9°	1	
		ARP6P-052A06AR	●	○	6	52	45	40	22	20	11	17	10.4	6.3	0.27	6.0	2.5	1.8	2.9°	1	
		ARP6P-063A07AR	●	○	7	63	50	40	22	20	11	17	10.4	6.3	0.44	6.0	2.5	2.50	3.1°	1	
		ARP6P-066X07AR	●	○	7	66	56	50	27	23	13	20	12.4	7	0.64	6.0	2.5	2.5	2.9°	1	
		ARP6P-080A09AR	●	○	9	80	56	50	27	23	13	20	12.4	7	0.88	6.0	2.5	2.50	2.3°	1	
		ARP6P-100B11AR	●	○	11	100	78	50	32	26	32	45	14.4	8	1.45	6.0	2.5	2.50	1.7°	2	

* WT : Poids de l'outil

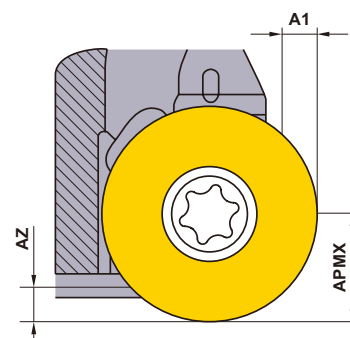

● : Article stocké. ★ : Article standard Japon.

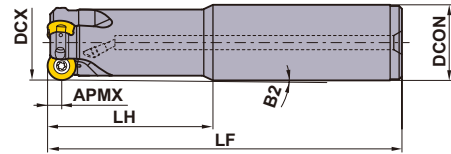

Fig.1

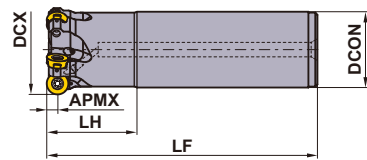

Fig.2





■ ATTACHEMENT CYLINDRIQUE

GAMP: +4° GAMF: -6° -7°

Type	Arête de coupe R (APMX)	Référence	Stock	R	Trou d'arrosage	Nombre de dents	Dimensions (mm)					WT* (kg)	Prof. de passe max. (mm)			RMPX	Fig.
							DCX	DCON	LF	LH	B2		APMX	A1	AZ		
Standard	5	ARP5PR2503SA25M	★	○	3	25	25	140	60	1.10°	0.42	5.0	1.0	0.40	1.8°	1	
		ARP5PR3204SA32M	★	○	4	32	32	150	70	0.92°	0.77	5.0	1.0	0.65	1.9°	1	
Série longue	5	ARP5PR2502SA25L	★	○	2	25	25	180	80	0.80°	0.56	5.0	1.0	0.40	1.8°	1	
		ARP5PR3203SA32L	★	○	3	32	32	200	120	0.51°	1.01	5.0	1.0	0.65	1.9°	1	
Standard	6	ARP6PR3203SA32M	★	○	3	32	32	150	70	0.94°	0.76	6.0	1.0	0.60	2.0°	1	
		ARP6PR4004SA32M	★	○	4	40	32	150	50	-	0.85	6.0	2.5	1.15	2.7°	2	
		ARP6PR5005SA42M	★	○	5	50	42	150	50	-	1.47	6.0	2.5	1.70	2.9°	2	
Série longue	6	ARP6PR3202SA32L	★	○	2	32	32	200	120	0.52°	1.00	6.0	1.0	0.60	2.0°	1	
		ARP6PR4003SA32L	★	○	3	40	32	250	50	-	1.48	6.0	2.5	1.15	2.7°	2	
		ARP6PR5004SA42L	★	○	4	50	42	250	50	-	2.53	6.0	2.5	1.70	2.9°	2	

* WT : Poids de l'outil

PIÈCES DÉTACHÉES

Référence porte-outil	 *1			
	Vis de plaquette	Clé	Antigrippant	Plaquette
ARP5	TPS351B	TIP10D	MK1KS	RPOT1040M0E4-○
ARP6	TPS4	TIP15D	MK1KS	RPOT1248M0E4-○

*1 Couple de serrage (N • m) : TPS351B=2,5, TPS4=3,5

*2 Buses d'arrosage disponibles en différents diamètres pour s'adapter à la pression d'arrosage disponible.

	≤ 1Mpa (≤ 20 l/min.)	← Standard →	≥ 5Mpa (≥ 30 l/min.)	≥ 7Mpa (≥ 50 l/min.)
Diam.de buse	ø0.6mm	ø0.8mm	ø1.2mm	ø1.6mm
Référence	HSD04004H06	HSD04004H08	HSD04004H12	HSD04004H16

* Couple de serrage (N • m) : HSD0400H○=1,5

*3 La référence de la buse d'arrosage brute, sans orifice est le HSS04004.

K

FRAISES À PLAQUETTES

FRAISES À PLAQUETTES

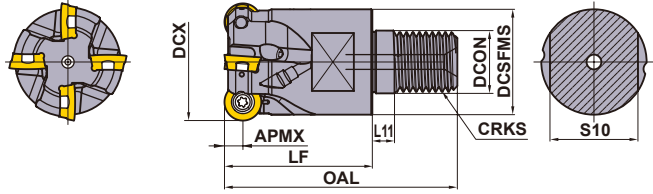

FRAISES À PLAQUETTES

K

■ FRAISE À EMBOUT FILETÉ

GAMP: +4° GAMF: -6° - -7°

Type	Arête de coupe R (APMX)	Référence	Stock		Nombre de dents	Dimensions (mm)							* WT (kg)	Prof. de passe max. (mm)			RMPX	
			R	Trou d'arrosage		DCX	DCON	DCSFMS	OAL	LF	L11	S10		CRKS	APMX	A1		AZ
Standard	5	ARP5PR2502AM1235	●	○	2	25	12.5	23.5	57	35	6	19	M12	0.10	5.0	-	0.40	1.8°
		ARP5PR3203AM1640	●	○	3	32	17.0	28.5	63	40	6	24	M16	0.16	5.0	1.0	0.65	1.9°
Pas réduit	5	ARP5PR2503AM1235	●	○	3	25	12.5	23.5	57	35	6	19	M12	0.09	5.0	-	0.40	1.8°
		ARP5PR3204AM1640	●	○	4	32	17.0	28.5	63	40	6	24	M16	0.15	5.0	1.0	0.65	1.9°
Standard	6	ARP6PR3202AM1640	●	○	2	32	17.0	28.5	63	40	6	24	M16	0.18	6.0	1.0	0.60	2.0°
		ARP6PR4003AM1640	●	○	3	40	17.0	28.5	63	40	6	24	M16	0.20	6.0	2.5	1.15	2.7°
Pas réduit	6	ARP6PR3203AM1640	●	○	3	32	17.0	28.5	63	40	6	24	M16	0.17	6.0	1.0	0.60	2.0°
		ARP6PR4004AM1640	●	○	4	40	17.0	28.5	63	40	6	24	M16	0.20	6.0	2.5	1.15	2.7°

* WT : Poids de l'outil

Remarque 1) Pour les arbres vissables, veuillez vous référer à la page K244.

● : Article stocké.

(10 plaquettes par boîte)

PLAQUETTES

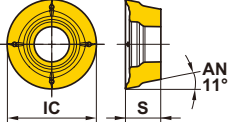
Matière		M	Acier Inoxydable	G	G	C	C	Conditions de coupe (Guide):				Honing :		
		S	Alliage réfractaire, Alliage titane					●	Coupe Stable	●	Coupe Générale		✱	Coupe Instable
Forme	Porte-outil	Référence	Type	Classe	Honing	Revêtu				Dimensions (mm)		APMX (mm)		Géométrie
						MC7020	MP7130	MP9130	NEW MP9140	IC	S	4 arêtes	8 arêtes	
	ARP5	RPHT1040M0E4-L	Faible effort de coupe, Haute précision	H	E	●	●	●		10	3.97	5.0	-	
		RPMT1040M0E4-L	Faible effort de coupe	M	E	●	●	●		10	3.97	5.0	-	
		NEW RPMT1040M0E8-L1	Faibles efforts, 8 arêtes	M	E	●	●	●	●	10	3.97	5.0	1.4	
		NEW RPMT1040M0E4-L2	Faible effort de coupe, Grande rigidité	M	E				●	10	3.97	5.0	-	
		RPHT1040M0E4-M	Générale, Haute précision	H	E	●	●	●		10	3.97	5.0	-	
		RPMT1040M0E4-M	Application générale	M	E	●	●	●		10	3.97	5.0	-	
		NEW RPMT1040M0E8-M1	Polyvalente, 8 arêtes	M	E	●	●	●	●	10	3.97	5.0	1.4	
		NEW RPMT1040M0E4-M2	Générale, Grande rigidité	M	E				●	10	3.97	5.0	-	
		RPHT1040M0E4-R	Arête renforcée, haute précision	H	E	●	●	●		10	3.97	5.0	-	
		RPMT1040M0E4-R	Arête renforcée	M	E	●	●	●		10	3.97	5.0	-	
	NEW RPMT1040M0E8-R1	Arête renforcée, 8 arêtes	M	E	●	●	●	●	10	3.97	5.0	1.4		
	ARP6	RPHT1248M0E4-L	Faible effort de coupe, Haute précision	H	E	●	●	●		12	4.76	6.0	-	
		RPMT1248M0E4-L	Faible effort de coupe	M	E	●	●	●		12	4.76	6.0	-	
		NEW RPMT1248M0E8-L1	Faibles efforts, 8 arêtes	M	E	●	●	●	●	12	4.76	6.0	1.7	
		NEW RPMT1248M0E4-L2	Faible effort de coupe, Grande rigidité	M	E				●	12	4.76	6.0	-	
		RPHT1248M0E4-M	Générale, Haute précision	H	E	●	●	●		12	4.76	6.0	-	
		RPMT1248M0E4-M	Application générale	M	E	●	●	●		12	4.76	6.0	-	
		NEW RPMT1248M0E8-M1	Polyvalente, 8 arêtes	M	E	●	●	●	●	12	4.76	6.0	1.7	
		NEW RPMT1248M0E4-M2	Générale, Grande rigidité	M	E				●	12	4.76	6.0	-	
		RPHT1248M0E4-R	Arête renforcée, haute précision	H	E	●	●	●		12	4.76	6.0	-	
RPMT1248M0E4-R		Arête renforcée	M	E	●	●	●		12	4.76	6.0	-		
NEW RPMT1248M0E8-R1	Arête renforcée, 8 arêtes	M	E	●	●	●	●	12	4.76	6.0	1.7			

● = NEW

K
FRAISES À PLAQUETTES

Profondeur de passe (ap) des plaquettes à 8 arêtes

Les plaquettes à 8 arêtes peuvent également être utilisées à la même profondeur de passe que les plaquettes à 4 arêtes.

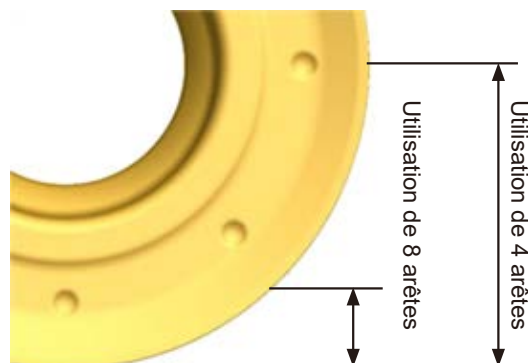

RALLONGES > K244
PIÈCES DÉTACHÉES > N001
DONNÉES TECHNIQUES > P001

K241

CONDITIONS DE COUPE RECOMMANDÉES

■ Usinage à sec

Matière	Dureté	Nuance	V _c (m/min)	fz (mm/dent)
M	≤200HB	MC7020	220 (170–270)	0.2 (0.1–0.35)
		MP7130	200 (150–250)	0.2 (0.1–0.35)
	>200HB	MC7020	190 (140–240)	0.2 (0.1–0.35)
		MP7130	170 (120–220)	0.2 (0.1–0.35)
	≤280HB	MC7020	180 (130–230)	0.2 (0.1–0.35)
		MP7130	160 (110–210)	0.2 (0.1–0.35)
	≤200MPa	MC7020	240 (190–290)	0.2 (0.1–0.35)
		MP7130	200 (150–250)	0.2 (0.1–0.35)
	>200HB	MC7020	240 (190–290)	0.2 (0.1–0.35)
		MP7130	200 (150–250)	0.2 (0.1–0.35)
	<450HB	MC7020	170 (120–220)	0.2 (0.1–0.35)
		MP7130	150 (100–200)	0.2 (0.1–0.35)

■ Coupe lubrifiée

Matière	Dureté	Nuance	V _c (m/min)	fz (mm/dent)
M	≤200HB	MC7020	150 (100–200)	0.2 (0.1–0.35)
		MP7130	130 (80–180)	0.2 (0.1–0.35)
	>200HB	MC7020	120 (70–170)	0.2 (0.1–0.35)
		MP7130	100 (80–150)	0.2 (0.1–0.35)
	≤280HB	MC7020	120 (70–170)	0.2 (0.1–0.35)
		MP7130	100 (80–150)	0.2 (0.1–0.35)
	≤200MPa	MC7020	170 (120–220)	0.2 (0.1–0.35)
		MP7130	130 (80–180)	0.2 (0.1–0.35)
	>200HB	MC7020	170 (120–220)	0.2 (0.1–0.35)
		MP7130	130 (80–180)	0.2 (0.1–0.35)
	<450HB	MC7020	110 (60–160)	0.2 (0.1–0.35)
		MP7130	90 (50–140)	0.2 (0.1–0.35)
S	–	MP9130	45 (30–55)	0.1 (0.05–0.15)
	–	MP9130	35 (15–45)	0.1 (0.05–0.15)

Remarque 1) Les conditions de coupe données sont censées éviter les vibrations (broutements) sur des machines et des pièces de grande raideur. Ajuster les conditions en cas de broutage et/ou d'écaillage de la plaquette.

Utiliser des conditions de coupe plus basses en cas de grand porte-à-faux et/ou d'usinage de poches.

Remarque 2) Les avances sont données pour ap = 2,5 mm avec l'ARP5 et ap = 3 mm avec l'ARP6

Corrigez l'avance en fonction de l'ap par le facteur de correction F du tableau ci-dessous.

Exemple : Avance recommandée pour ARP5, SUS304, MP7130, ap = 1 : fz = 0,2 mm/dent × 1,5 (facteur de correction F)=0,3 mm/dent.

Remarque 3) En rainurage, réduire l'avance à 70 % de la valeur nominale. En ramping, perçage et tréflage, utilisez 50%.

Remarque 4) L'arrosage interne est recommandé pour l'usinage d'alliages de titane et réfractaires.

L'utilisation de buses d'arrosage (vendues séparément) augmente l'efficacité de l'arrosage.

CAPACITÉS D'USINAGE MAXIMALES

Arête de coupe APMX (mm)	Diamètre de trou maximum DCX (mm)	Référence	Attachement	Type	Recommandation (mm)		Ramping RMPX(deg)	Perçage hélicoïdal		Prof. de perçage Maximum AZ(mm)	Plongée AE1(mm)
					ap	ae		Plus petit trou DH min.(mm)	Plus grand trou DH max.(mm)		
5	25	ARP5PR2502AM1235	Fraise à embout fileté	Standard	≤2.5	≤1.00DCX	1.8°	40	48	0.40	—
		ARP5PR2503AM1235	Fraise à embout fileté	Pas réduit	≤1.5	≤1.00DCX	1.8°	40	48	0.40	—
		ARP5PR2503SA25M	Corps	Standard	≤1.5	≤1.00DCX	1.8°	40	48	0.40	1.0
		ARP5PR2502SA25L	Corps	Coupe Longue	≤1.5	≤1.00DCX	1.8°	40	48	0.40	1.0
	32	ARP5PR3203AM1640	Fraise à embout fileté	Standard	≤2.5	≤1.00DCX	1.9°	54	62	0.65	1.0
		ARP5PR3204AM1640	Fraise à embout fileté	Pas réduit	≤2.5	≤1.00DCX	1.9°	54	62	0.65	1.0
		ARP5PR3204SA32M	Corps	Standard	≤2.5	≤1.00DCX	1.9°	54	62	0.65	1.0
		ARP5PR3203SA32L	Corps	Coupe Longue	≤2.5	≤1.00DCX	1.9°	54	62	0.65	1.0
	40	ARP5P-040A05AR	Attachement	Pas réduit	≤2.5	≤1.00DCX	2.8°	70	78	1.30	2.0
	50	ARP5P-050A06AR	Attachement	Pas réduit	≤2.5	≤1.00DCX	2.9°	90	98	1.85	2.0
		ARP5P-050A07AR	Attachement	Pas extra fin	≤1.5	≤1.00DCX	2.9°	90	98	1.85	2.0
	63	ARP5P-063A07AR	Attachement	Pas réduit	≤2.5	≤0.75DCX	3.0°	116	124	2.50	2.5
ARP5P-063A08AR		Attachement	Pas extra fin	≤1.5	≤0.75DCX	3.0°	116	124	2.50	2.5	
6	32	ARP6PR3202AM1640	Fraise à embout fileté	Standard	≤3.5	≤1.00DCX	2.0°	52	62	0.60	1.0
		ARP6PR3203AM1640	Fraise à embout fileté	Pas réduit	≤3.5	≤1.00DCX	2.0°	52	62	0.60	1.0
		ARP6PR3203SA32M	Corps	Standard	≤3.5	≤1.00DCX	2.0°	52	62	0.60	1.0
		ARP6PR3202SA32L	Corps	Coupe Longue	≤3.5	≤1.00DCX	2.0°	52	62	0.60	1.0
	40	ARP6PR4003AM1640	Fraise à embout fileté	Standard	≤3.5	≤1.00DCX	2.7°	68	78	1.15	2.5
		ARP6PR4004AM1640	Fraise à embout fileté	Pas réduit	≤3.5	≤1.00DCX	2.7°	68	78	1.15	2.5
		ARP6PR4004SA32M	Corps	Standard	≤3.5	≤1.00DCX	2.7°	68	78	1.15	2.5
		ARP6PR4003SA32L	Corps	Coupe Longue	≤3.5	≤1.00DCX	2.7°	68	78	1.15	2.5
		ARP6P-040A04AR	Attachement	Pas réduit	≤3.5	≤1.00DCX	2.7°	68	78	1.15	2.0
	50	ARP6PR5005SA42M	Corps	Standard	≤3.5	≤1.00DCX	2.9°	88	98	1.70	2.5
		ARP6PR5004SA42L	Corps	Coupe Longue	≤3.5	≤1.00DCX	2.9°	88	98	1.70	2.5
		ARP6P-050A05AR	Attachement	Pas réduit	≤3.5	≤1.00DCX	2.9°	88	98	1.70	2.0
		ARP6P-050A06AR	Attachement	Pas extra fin	≤2.5	≤1.00DCX	2.9°	88	98	1.70	2.0
	63	ARP6P-063A06AR	Attachement	Pas réduit	≤3.5	≤0.75DCX	3.1°	114	124	2.50	2.5
		ARP6P-063A07AR	Attachement	Pas extra fin	≤2.5	≤0.75DCX	3.1°	114	124	2.50	2.5
	80	ARP6PR08008CA	Attachement	Pas réduit	≤3.5	≤0.60DCX	2.3°	148	158	2.50	2.5
		ARP6PR08009CA	Attachement	Pas extra fin	≤2.5	≤0.60DCX	2.3°	148	158	2.50	2.5
	100	ARP6PR10009DA	Attachement	Pas réduit	≤3.5	≤0.50DCX	1.7°	188	198	2.50	2.5
ARP6PR10011DA		Attachement	Pas extra fin	≤2.5	≤0.50DCX	1.7°	188	198	2.50	2.5	

Remarque 1) La durée de vie du corps d'outil peut être détériorée si la profondeur de passe excède 5 mm avec l'ARP5 et 6 mm avec l'ARP6.

Remarque 2) En perçage, attention aux projections de copeaux longs.

Remarque 3) Lors de coupes hélicoïdales, ne dépassez pas la profondeur de coupe maximale APMX par rotation.

Remarque 4) Calculez en utilisant la formule suivante pour la trajectoire du centre outil et le diamètre d'alésage souhaité : diamètre d'alésage souhaité = diamètre de la trajectoire circulaire + ϕ DH diamètre d'outil + ϕ DCX

Remarque 5) Pour éviter tout risque de blessure, ne pas manipuler les copeaux mains nues.

Remarque 6) Les poches à copeaux sont petites sur les outils à pas extra-fin et de petit diamètre.

Réglez l'avance, l'ae et l'ap avec prudence à cause du risque de bourrage.

Remarque 7) Lorsque vous coupez avec une grande ae avec une fraise de grand diamètre, un bourrage est possible.

Réglez l'ap et l'avance.

■ CORRECTION DE L'AVANCE EN FONCTION DE LA PROFONDEUR DE PASSE (FACTEUR F)

Porte-outil	ap=0.5mm	ap=1mm	ap=1.5mm	ap=2mm	ap=2.5mm	ap=3mm	ap=3.5mm	ap=4mm	ap=5mm	ap=6mm
ARP5	2.3	1.5	1.2	1.1	1.0	0.9	0.8	0.8	0.8	—
ARP6	2.5	1.7	1.3	1.1	1.0	1.0	0.9	0.9	0.8	0.8

Remarque 1) La durée de vie du corps d'outil peut être détériorée si la profondeur de passe excède 5 mm avec l'ARP5 et 6 mm avec l'ARP6.

K

FRAISES À PLAQUETTES

RALLONGES

FRAISES À PLAQUETTES

K

■ RALLONGES DROITES

Type	Référence	Stock	Dimensions (mm)						
			DCB	DCONMS	DCONWS	LF	LB	H	CRKS
CORPS ACIER	SC16M08S100S	★	8.5	16	14.5	100	10	10	M8
	SC16M08S200L	★	8.5	16	14.5	200	10	10	M8
	SC20M10S120S	★	10.5	20	18.5	120	10	14	M10
	SC20M10S220L	★	10.5	20	18.5	220	10	14	M10
	SC25M12S125S	★	12.5	25	23.5	125	10	19	M12
	SC25M12S245L	★	12.5	25	23.5	245	10	19	M12
	SC32M16S140S	★	17	32	28.5	140	15	24	M16
	SC32M16S280L	★	17	32	28.5	280	15	24	M16
CORPS CARBURE	SC16M08S100SW	★	8.5	16	14.5	100	10	10	M8
	SC16M08S200LW	★	8.5	16	14.5	200	10	10	M8
	SC20M10S120SW	★	10.5	20	18.5	120	10	14	M10
	SC20M10S220LW	★	10.5	20	18.5	220	10	14	M10
	SC25M12S125SW	★	12.5	25	23.5	125	10	19	M12
	SC25M12S245LW	★	12.5	25	23.5	245	10	19	M12
	SC32M16S140SW	★	17	32	28.5	140	15	24	M16
	SC32M16S280LW	★	17	32	28.5	280	15	24	M16

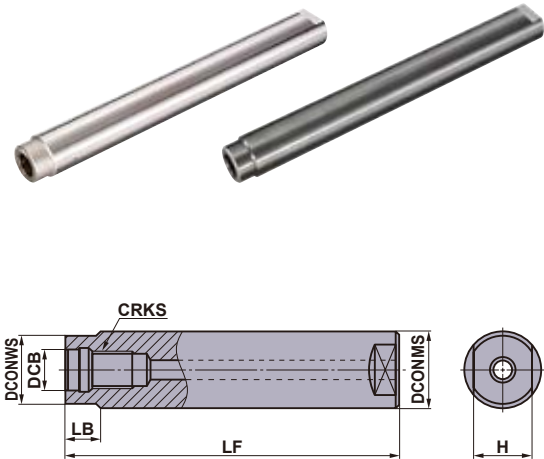

INSTALLATION DE LA FRAISE VISSÉE

- Avant l'installation et le serrage de la fraise sur la rallonge nettoyer les deux éléments avec une soufflette ou une brosse.
- Serrer la fraise avec le couple recommandé et s'assurer qu'il n'y a aucun espace entre la fraise et la rallonge.

Taille de la vis	Couple recommandé (N • m)	Taille de la clé (mm)
M8	23	10
M10	46	14
M12	80	19
M16	90	24



- Les outils peuvent devenir très chauds pendant l'usinage. Ne les toucher en aucun cas avec les mains car il y a risque de brûlure ou de blessure.

★ : Article standard Japon.

■ CÔNE HSK63A

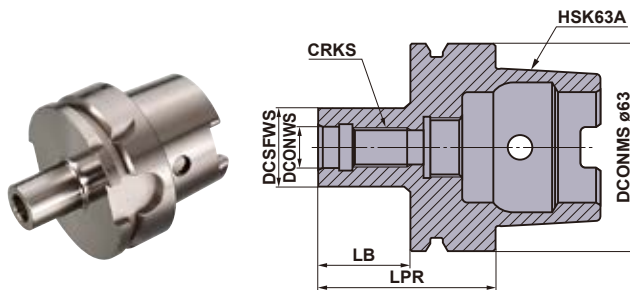

Référence	Stock	Dimensions (mm)				
		DCONWS	DCSFWS	LPR	LB	CRKS
SC16M08S22-HSK63A	★	8.5	14.5	48	22	M8
SC20M10S24-HSK63A	★	10.5	18.5	50	24	M10
SC25M12S27-HSK63A	★	12.5	23.5	53	27	M12
SC32M16S28-HSK63A	★	17.0	28.5	54	28	M16

Remarque 1) L'attache type HSK63A est fourni avec pipette d'arrosage.

K

FRAISES À PLAQUETTES

VITESSE DE ROTATION MAXI AUTORISÉE POUR LES FRAISES

K

FRAISES À PLAQUETTES

Diamètres (mm)	WSX445		ASX445		WWX400		ASX400		FMAX	
	Vitesse de rotation maxi. recommandée (min ⁻¹)	Couple de serrage (N • m)	Vitesse de rotation maxi. recommandée (min ⁻¹)	Couple de serrage (N • m)	Vitesse de rotation maxi. recommandée (min ⁻¹)	Couple de serrage (N • m)	Vitesse de rotation maxi. recommandée (min ⁻¹)	Couple de serrage (N • m)	Vitesse de rotation maxi. recommandée (min ⁻¹)	Couple de serrage (N • m)
40	19000	3.5	—	—	—	—	—	—	30000	3.5
50	17000	3.5	18000	3.5	5000	5.0	18000	3.5	30000	3.5
63	15000	3.5	16000	3.5	14100	5.0	16000	3.5	27000	3.5
80	14000	3.5	14000	3.5	12200	5.0	14000	3.5	24500	3.5
100	12000	3.5	13000	3.5	10700	5.0	13000	3.5	22000	3.5
125	11000	3.5	12000	3.5	9500	5.0	12000	3.5	19600	3.5
160	9500	3.5	10000	3.5	8300	5.0	10000	3.5	—	—
200	8500	3.5	9000	3.5	7300	5.0	9000	3.5	—	—
250	—	—	8000	3.5	6400	5.0	8000	3.5	—	—
315	—	—	6500	3.5	—	—	—	—	—	—

Diamètres (mm)	AHX440S		AHX475S		AHX640S		AHX640W		WJX14	
	Vitesse de rotation maxi. recommandée (min ⁻¹)	Couple de serrage (N • m)	Vitesse de rotation maxi. recommandée (min ⁻¹)	Couple de serrage (N • m)	Vitesse de rotation maxi. recommandée (min ⁻¹)	Couple de serrage (N • m)	Vitesse de rotation maxi. recommandée (min ⁻¹)	Couple de serrage (N • m)	Vitesse de rotation maxi. recommandée (min ⁻¹)	Couple de serrage (N • m)
40	21000	3.5	—	—	—	—	—	—	—	—
50	19800	3.5	18300	3.5	—	—	—	—	5000	5.0
52	—	—	—	—	—	—	—	—	5000	5.0
63	18300	3.5	17200	3.5	12000	5	—	—	18200	5.0
66	—	—	—	—	—	—	—	—	17700	5.0
80	16500	3.5	15700	3.5	10000	5	8900	6	15600	5.0
100	14600	3.5	14000	3.5	8700	5	7800	6	13500	5.0
125	12600	3.5	12200	3.5	7500	5	6600	6	11600	5.0
160	10200	3.5	9900	3.5	6100	5	5300	6	9900	5.0
200	—	—	—	—	5100	5	4100	6	—	—
250	—	—	—	—	—	—	2900	6	—	—
315	—	—	—	—	—	—	1700	6	—	—

Diamètres (mm)	AXD4000		AXD7000		VPX200		VPX300		WJX09	
	Vitesse de rotation maxi. recommandée (min ⁻¹)	Couple de serrage (N • m)	Vitesse de rotation maxi. recommandée (min ⁻¹)	Couple de serrage (N • m)	Vitesse de rotation maxi. recommandée (min ⁻¹)	Couple de serrage (N • m)	Vitesse de rotation maxi. recommandée (min ⁻¹)	Couple de serrage (N • m)	Vitesse de rotation maxi. recommandée (min ⁻¹)	Couple de serrage (N • m)
16	—	—	—	—	37900	1.0	—	—	—	—
18	—	—	—	—	35300	1.0	—	—	—	—
20	15000	1.5	—	—	33200	1.0	—	—	—	—
22	—	—	—	—	31400	1.0	—	—	—	—
25	49000	1.5	—	—	29000	1.0	24100	3.0	33500	2.0
28	48500	1.5	—	—	27200	1.0	22500	3.0	30300	2.0
30	—	—	—	—	26000	1.0	21500	3.0	—	—
32	48000	1.5	41000	3.5	25100	1.0	20600	3.0	27300	2.0
35	45000	1.5	—	—	23800	1.0	19500	3.0	25500	2.0
40	41000	1.5	36000	3.5	22000	1.0	17900	3.0	23200	2.0
50	35000	1.5	30000	3.5	19200	1.0	15500	3.0	20000	2.0
52	—	—	—	—	—	—	—	—	19500	2.0
63	30000	1.5	25000	3.5	16700	1.0	13400	3.0	17300	2.0
66	—	—	—	—	—	—	—	—	16800	2.0
80	27000	1.5	23000	3.5	—	—	11500	3.0	—	—
100	23000	1.5	19000	3.5	—	—	—	—	—	—
125	20000	1.5	16000	3.5	—	—	—	—	—	—
160	—	—	—	—	—	—	—	—	—	—

Remarque 1) Les valeurs ci-dessus sont indiquées pour une plaquette correctement installée dans le corps de fraise et serrée au couple recommandé.

LISTE DES TOLÉRANCES POUR LE DIAMÈTRE DES FRAISES

Fraise	Tolérance du diamètre de l'arête de coupe (mm)	Fraise	Tolérance du diamètre de l'arête de coupe (mm)
AJX	-0.1 -0.4	CBMP	0 -0.3
APX3000 Attachement Par Alésage	-0.1 -0.4	PMF	0 -0.3
APX3000 Attachement Cylindrique	-0.1 -0.2	PMR	0 -0.3
APX3000 Série Longue	-0.1 -0.3	SPX	-0.1 -0.3
APX4000 Attachement Par Alésage	-0.1 -0.4	SRF	0 -0.027
APX4000 Attachement Cylindrique	-0.1 -0.2	SRM	-0.05 -0.15
APX4000 Série Longue	-0.1 -0.3	SUF	0 -0.02
AQX	-0.1 -0.3	TSMP	-0.1 -0.3
ARP Attachement Par Alésage	-0.1 -0.3	VFX5, VFX6 Fraise à Alésage	-0.1 -0.3
ARP Attachement Cylindrique	-0.1 -0.2	VOX400 Attachement Par Alésage	-0.1 -0.4
ASX400	0 -0.3	VPX Attachement Par Alésage	-0.1 -0.3
AXD4000 Attachement Par Alésage	-0.1 -0.4	VPX Attachement Cylindrique	-0.1 -0.2
AXD4000 Attachement Cylindrique	-0.1 -0.2	VPX Série Longue	-0.1 -0.3
AXD7000 Attachement Par Alésage	-0.1 -0.4	WJX Attachement Par Alésage	-0.1 -0.3
AXD7000 Attachement Cylindrique	-0.1 -0.2	WJX Attachement Cylindrique	-0.1 -0.3
BRP	-0.1 -0.3	WWX400 Attachement Par Alésage	-0.1 -0.3
CBJP	0 -0.3	WWX400 Attachement Cylindrique	-0.1 -0.3

Remarque 1) Tolérance du diamètre de l'arête de coupe si la plaquette est montée et réglée.

Remarque 2) Pour les fraises SRF, la tolérance de la plaquette doit être ajoutée à la tolérance mentionnée ci-dessus.

K

FRAISES À PLAQUETTES

COMMENT LIRE LA NORME DES PLAQUETTES POUR OUTILS ROTATIFS

● Classification des plaquettes de fraisage

- ① Classification par type de fraise.
- ② Fraises classées par ordre alphabétique.

● Comment les plaquettes standards de fraisage sont-elles organisées ?

- ① Classement par familles : plaquettes de fraisage, plaquettes de planage, plaquettes de perçage
- ② Classement alphabétique par référence

NUANCES RECOMMANDÉES POUR CHAQUE MATIÈRE
Des conditions de coupe appropriées pour chaque matériau sont présentées comme un guide général pour sélectionner la nuance.

- : Coupe Stable
- ◐ : Coupe Générale
- ✱ : Coupe Instable

TITRE DE LA PAGE

SECTION PRODUIT

PLAQUETTES DE FRAISAGE			CLASSIFICATION		
Fraise	Référence	Page	Fraise	Référence	Page
AHX440S	NNMU13050ZSR-L	L030	APX3000	AOMT123604PEER-H AOMT123608PEER-H AOMT123616PEER-H	L022
	WNEU13052ZEN-M	L049	APX4000	AOMT184804PEER-M AOMT184810PEER-M AOMT184815PEER-M AOMT184820PEER-M	L022
AHX440S AHX413S	NNMU13050ZSR-M	L030	AJX	JOMT06T16ZSR-JM JOMT09T32OZSR-JM JOMT1402ZDSR-JM JOMT14020ZSR-JM JOMW06T216ZSR-FT JOMW06T328ZSR-FT JOMW09T328ZSR-FT JOMW1240ZDSR-FT JOMW1602ZDSR-FT	L024
	NNMU13053ZEN-R	L030	AOX	QOGT0830R-G1 QOGT1035R-G1 QOGT1342R-G1 QOGT1651R-G1 QOGT1898R-G1 QOGT2062R-G1 QOGT2576R-G1	L032
AHX640S	WNEU2007ZEN-C	L049	APX3000 CK133	QOMT0830R-M2 QOMT1035R-M2 QOMT1342R-M2 QOMT1651R-M2 QOMT1856R-M2 QOMT2062R-M2 QOMT2576R-M2	L032
	NNMU200708Z-MP	L031	APX3000 CK147	AOMT123602PEER-M AOMT123604PEER-M AOMT123608PEER-M AOMT123616PEER-M AOMT123624PEER-M AOMT123630PEER-M AOMT123632PEER-M	L022
NNMU200708ZEN-M	NNMU200708ZEN-M	L031	APX4000 CK149	RPHY1040M0E4-L RPHY1248M0E4-L RPHY1040M0E4-M RPHY1248M0E4-M RPHY1040M0E4-R RPHY1248M0E4-R	L034
	NNMU200712ZER-MM	L031	APX4000 CK151	AOMT123610PEER-M AOMT123616PEER-M AOMT123620PEER-M AOMT123630PEER-M AOMT123632PEER-M	L022
WNEU2007ZEN-C-WP	L050				

L014

RÉFÉRENCE PLAQUETTE

FRAISE

PHOTO DE LA PLAQUETTE

RENOVI DE PAGE

indique les pages contenant les caractéristiques détaillées de plaquettes spécifiques.

APPLICATION

RÉFÉRENCE PLAQUETTE

TOLÉRANCE PLAQUETTE - HONING

NUANCE PLAQUETTE

PLAQUETTES DE FRAISAGE			PLAQUETTES DE FRAISAGE												Géométrie
Forme	Référence	Catégorie	Revêtu	Chape	Dimensions (mm)						État de stock				
					L	LE	W1	S	BS	RE					
WWX400 CK956	ENGLU409040PNFR-L	G	●	●	7	17	0.4	—	—	7	1.7	0.4	●		
	ENGLU409050PNFR-L	G	●	●	7	13	0.8	—	—	7	1.3	0.8	●		
	ENGLU409040PNFR-L	G	●	●	7	17	0.4	—	—	7	1.7	0.4	●		
	ENGLU409050PNFR-L	G	●	●	7	13	0.8	—	—	7	1.3	0.8	●		
APX3000 CK133	ADGT123602PEFR-GM	G	●	●	12	10	6.6	3.6	1.8	0.2	—	—	●		
	ADGT123604PEFR-GM	G	●	●	12	10	6.6	3.6	1.6	0.4	—	—	●		
APX3000 CK133	AOMT123604PEER-H	M	●	●	12	10	6.6	3.6	1.6	0.4	—	—	●		
	AOMT123608PEER-H	M	●	●	12	10	6.6	3.6	1.2	0.8	—	—	●		
APX3000 CK149	AOMT123604PEER-H	M	●	●	12	10	6.6	3.6	1.6	0.4	—	—	●		
	AOMT123616PEER-H	M	●	●	12	10	6.6	3.6	1.2	0.8	—	—	●		

L022

GÉOMÉTRIE PLAQUETTE

DIMENSIONS PLAQUETTE

ÉTAT DE STOCK

LÉGENDE DES INDICATEURS DE L'ÉTAT DE STOCK en bas à gauche de la double page.

● Lors de la commande veuillez spécifier :

- ① Référence et nuance de la plaquette

FRAISAGE À PLAQUETTES

PLAQUETTES STANDARD PLAQUETTES STANDARD CBN & PCD NUANCES









IDENTIFICATION.....	L002
NUANCES POUR LE FRAISAGE	L004
PLAGE DES APPLICATIONS DE FRAISAGE	L005
CARBURE REVÊTU (CVD & PVD)	L008
CERMET	L010
CARBURE NON-REVÊTU	L011
CBN (CBN FRITTÉ)	L012
PCD (DIAMANT FRITTÉ).....	L013
CLASSIFICATION.....	L014

PLAQUETTES DE FRAISAGE STANDARD







PLAQUETTES DE COUPE	L022
PLAQUETTES DE PLANAGE	L049
PLAQUETTES DE COUPE CBN ET PCD.....	L051
PLAQUETTES DE PLANAGE CBN ET PCD.....	L052



IDENTIFICATION



Symbole	Forme plaquette	
6	Conception spéciale	—
N	Heptagonale	
O	Octogonale	
S	Carrée	
T	Triangulaire	
C	Rhombique 80°	
M	Rhombique 86°	
A	Parallélogramme 85°	
R	Ronde	
L	Rectangulaire	
J	Conception spéciale	—
X	Conception spéciale	—
W	Planage (Wiper)	—

① Forme plaquette



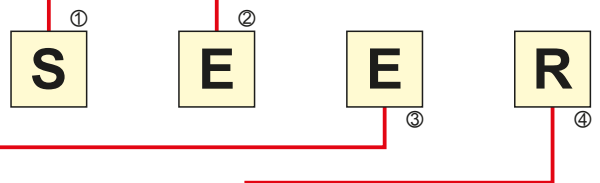

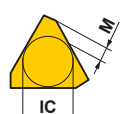

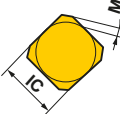
Symbole	Dépouille Normale AN	
C	7°	
D	15°	
E	20°	
F	25°	
G	30°	
N	0°	
P	11°	
O	Autre	
X	Autre	

② Dépouille Normale



③ Classe de tolérance			
			
Symbole	Cote sur pige M (mm)	Tolérance du cercle inscrit IC (mm)	Épaisseur S (mm)
A	±0.005	±0.025	±0.025
C	±0.013	±0.025	±0.025
E	±0.025	±0.025	±0.025
G	±0.025	±0.025	±0.13
K*	±0.013	±0.05—±0.15	±0.025
M*	±0.08—±0.18	±0.05—±0.15	±0.13
N*	±0.08—±0.18	±0.05—±0.15	±0.025

Les plaquettes marquées * sont brutes de frittage.

④ Type de fixation / Brise-copeaux				
Symbole	Trou	Configuration du trou	Brise copeaux	Schéma
W	Avec Trou	Trou Cylindrique + Chanfrein (40°—60°)	Non	
T	Avec Trou	Trou Cylindrique + Chanfrein (40°—60°)	Monoface	
U	Avec Trou	Trou Cylindrique + Chanfrein (40°—60°)	Sur les 2 faces	
B	Avec Trou	Trou Cylindrique + Chanfrein (70°—90°)	Non	
N	Sans Trou	—	Non	
R	Sans Trou	—	Monoface	
X	—	—	—	Conception spéciale

Symbole				Diamètre du cercle inscrit (mm)
	06	06	11	6.35
	08	07	13	7.94
	09	09	16	9.525
10				10.00
12				12.00
	12	12	22	12.70
	16	15	27	15.875
20				20.00

⑤ Taille plaquette

Symbole	Épaisseur plaquette (mm)
03	3.18
T3	3.97
04	4.76

⑥ Épaisseur plaquette

Symbole	Honing
F	Arête vive
E	Rayon
T	Chanfrein
S	Chanfrein+Rayon
X	Rayon (Petit)
Z	Chanfrein (Arête de coupe renforcée)

⑨ Configuration de l'arête

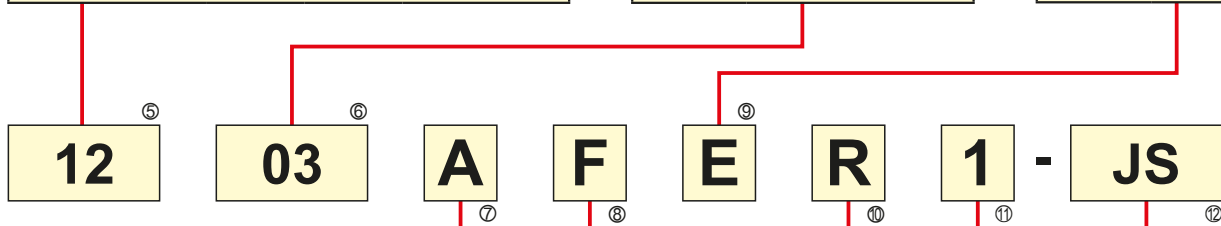

⑦ Angle d'attaque

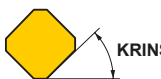

Symbole	Angle d'attaque
A	45°
E	75°
P	90°
Z	Autre angle

⑧ Angle de dépouille du plat de planage

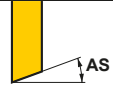

Symbole	Angle de dépouille
D	15°
E	20°
F	25°
G	30°
N	0°
P	11°

⑩ Direction de coupe

L	A gauche
N	Neutre
R	A droite

⑪ Largeur plat de planage

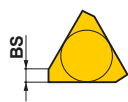

Symbole	BS (mm)
1	1.4 (1,94 seulement pour TEKN.)
2	2.4

⑫ Brise-copeaux

Symbole	Nom
FT	Brise-copeaux FT
HS	Brise-copeaux HS
JH	Brise-copeaux JH
JM	Brise-copeaux JM
JS	Brise-copeaux JS
JL	Brise-copeaux JL
JP	Brise-copeaux JP
LS	Brise-copeaux LS
MM	Brise-copeaux MM
MS	Brise-copeaux MS
L	Brise-copeaux L
M	Brise-copeaux M
R	Brise-copeaux R

NUANCES DE FRAISAGE

● NUANCES PLAQUETTES DE FRAISAGE

PLAQUETTES DE FRAISAGE

ISO	Carbure revêtu		Cermet revêtu	Cermet	Carbure non-revêtu	CBN (CBN fritté)	PCD (Diamant fritté)
	CVD	PVD					
P Acier	10	MC7020, FH7020					
	20	F7030					
	30	MP6120, VP15TF, MP6130, UP20M, VP20RT					
	40		VP30RT				
				VP25N	NX2525, MX3020, MX3030, NX4545	UTi20T	
M Acier inoxydable	10	MC7020					
	20	F7030					
	30	VP15TF, MP7130, MP7030, UP20M, VP20RT					
	40		MP7140, VP30RT				
				VP25N	NX2525, MX3020, MX3030, NX4545	UTi20T	
K Fonte	10	MC5020					
	20	MP8010, VP15TF					
	30		VP20RT				
			VP25N	NX2525, MX3020, MX3030	HTi05T, HTi10, UTi20T	MB710, MB4120	
N Métaux non ferreux	10						
	20						
					HTi10, TF15	MD220, MD2030	
S Alliage réfractaire • Alliage Ti	10						
	20						
	30		MP9120, VP15TF, MP9130				
	40		MP9140				
H Matières traitées / trempées	10						
	20		MP8010, VP15TF				
	30						

PLAGE D'APPLICATION DES NUANCES

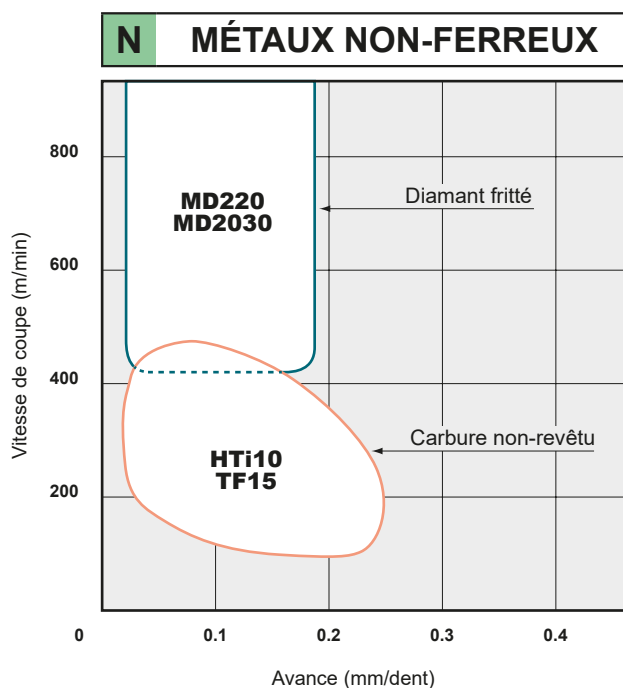
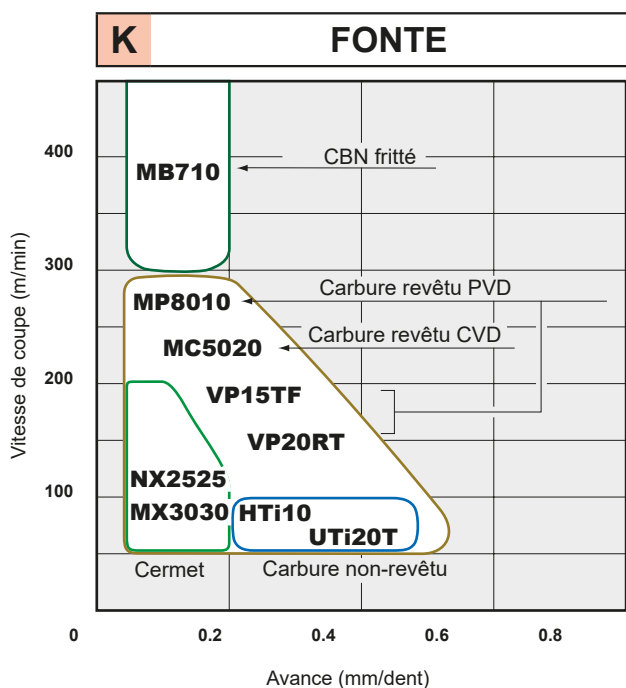
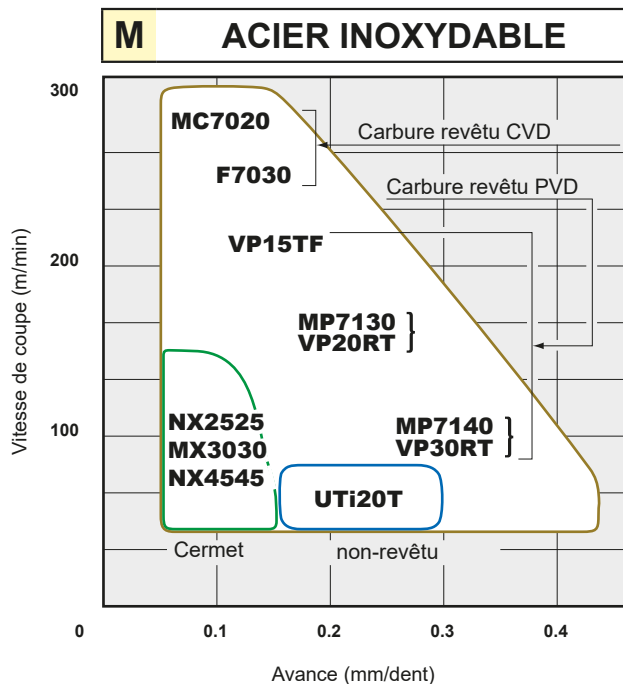
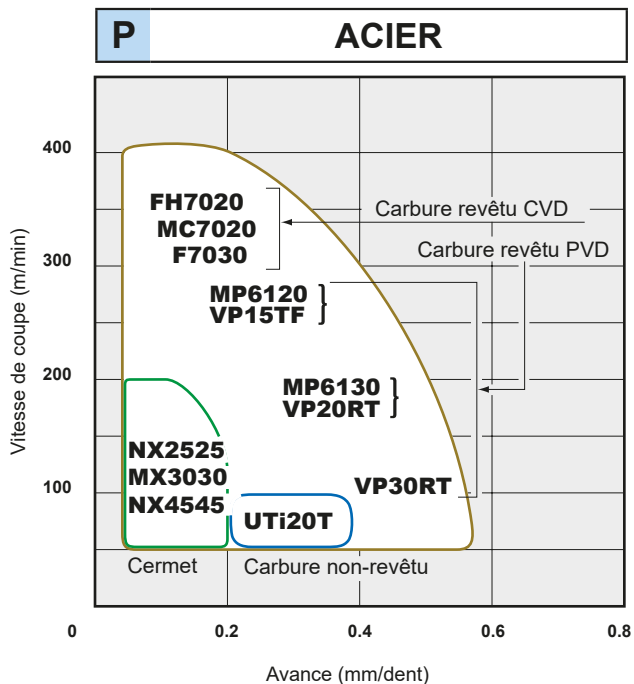

PLAQUETTES DE FRAISAGE

PLAGE D'APPLICATION DES NUANCES

● La préconisation de la nuance plaquette est basée en fonction de la vitesse de coupe et des conditions pour chaque matière.

PLAQUETTES DE FRAISAGE

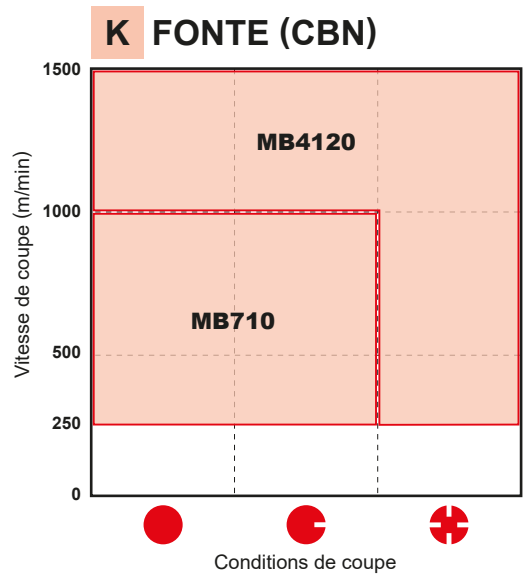
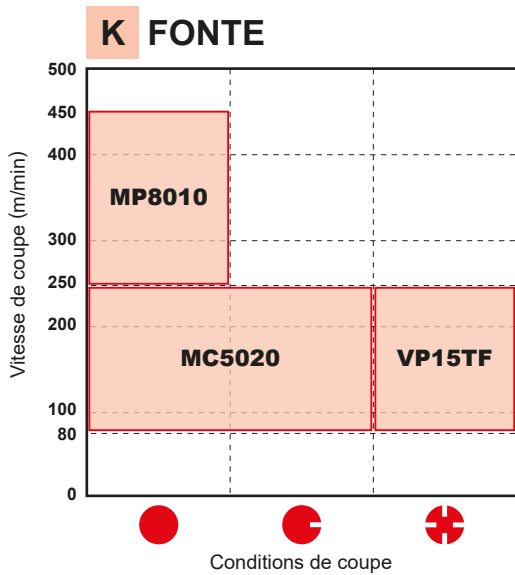
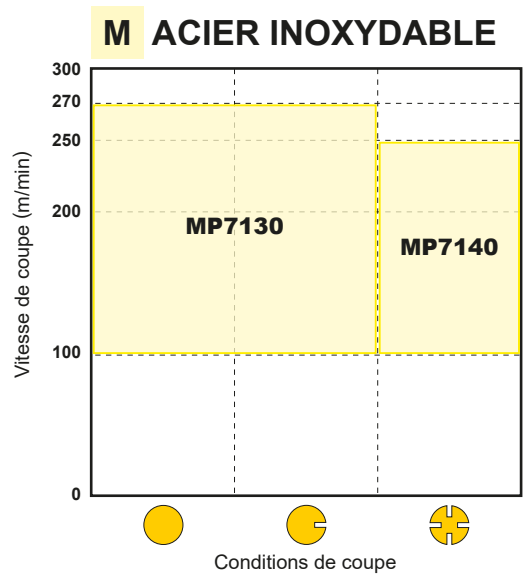
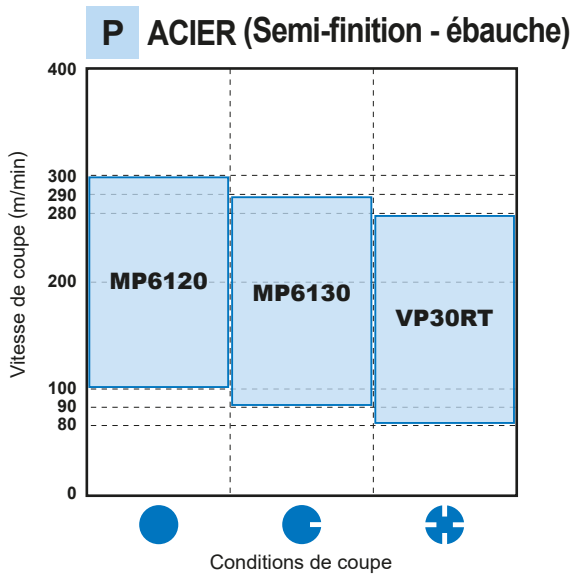

■ CONDITIONS DE COUPE



Coupe Stable

Coupe plane
Profondeur de passe constante
Pré-usinage
Sécurité d'indexation



Coupe Générale



Coupe Instable

Travaux Lourds Interrompus
Profondeur de Passe Irrégulière
Faible Sécurité d'Indexation

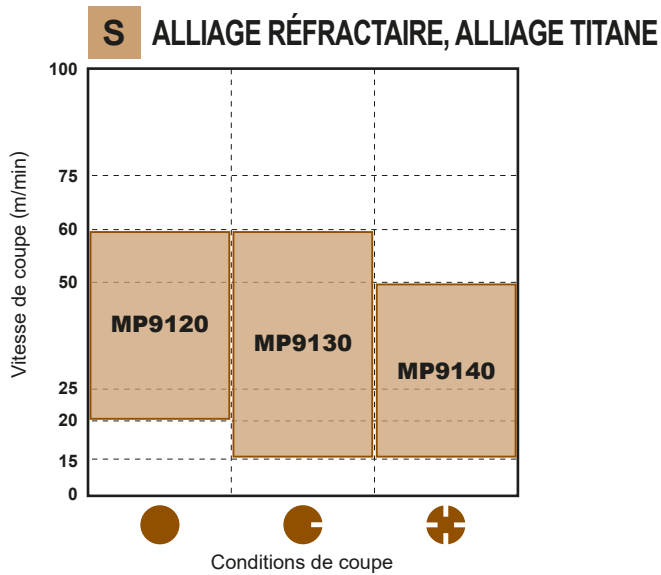
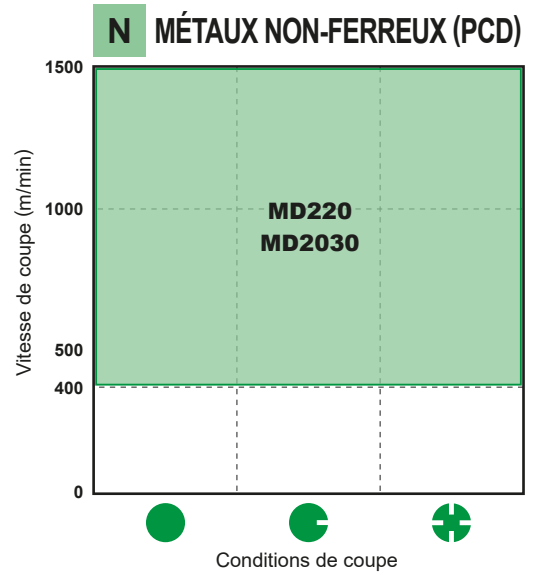
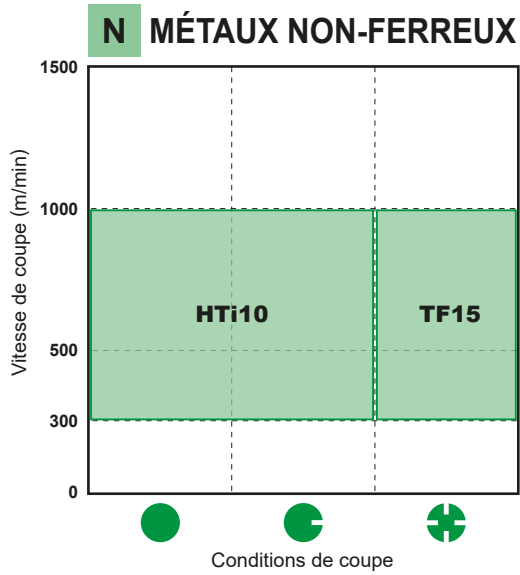

CARBURE REVÊTU(CVD&PVD)

<CVD>

- Structure fibreuse spéciale, très tenace, qui améliore la résistance à l'usure et à l'écaillage.
- Couvre une large plage d'applications et réduit le nombre d'outils requis.

<PVD>

- Le revêtement PVD prolonge la durée de vie de l'outil par rapport au carbure non-revêtu à de mêmes conditions de coupe.
- Des outils revêtus avec une grande acuité : c'est possible. Sans perte de performance et sans changer la qualité du substrat.

■ SÉLECTION FRAISAGE

PLAQUETTES DE FRAISAGE

Matière	Nuance recommandée	ISO	Gamme d'application
P Acier	F7030	P	
	MC7020		
	MP6120		
	MP6130		
	VP15TF		
M Acier inoxydable	F7030	M	
	MC7020		
	MP7030		
	MP7130		
	MP7140		
	VP15TF		
K Fonte	MC5020	K	
	VP15TF		
N Alliage aluminium	LC15TF	N	
S Alliage réfractaire Alliage Ti	MP9120	S	
	VP15TF		
	MP9130		
	NEW MP9140		
H Matières traitées / trempées	MP8010	H	
	VP15TF		

■ CARACTÉRISTIQUES DES NUANCES

Nuance	Substrat		Revêtement		Nuance	Substrat		Revêtement	
	Dureté (HRA)	Composition	Épaisseur	Dureté (HRA)		Composition	Épaisseur		
MC5020	91.0	TiCN-Al ₂ O ₃ -Ti	Épais	MP8010	93.5	(Al,Ti,Si)N	Mince		
MC7020	88.8	TiCN-Al ₂ O ₃	Épais	MP9120	91.5	(Al,Ti,Cr)N	Mince		
FH7020	89.0	TiCN-Al ₂ O ₃ -Ti	Épais	MP9130	90.5	(Al,Ti,Cr)N	Mince		
F7030	88.8	TiCN-Al ₂ O ₃ -TiN	Mince	NEW MP9140	89.0	(Al,Ti)N	Mince		
MP6120	91.5	(Al,Ti,Cr)N	Mince	VP15TF	91.5	(Al,Ti)N	Mince		
MP6130	90.5	(Al,Ti,Cr)N	Mince	VP20RT	90.5	(Al,Ti)N	Mince		
MP7030	90.5	(Al,Ti)N-Ti	Mince	VP30RT	88.8	(Al,Ti)N	Mince		
MP7130	90.5	(Al,Ti)N-Ti	Mince	UP20M	90.5	Ti	Mince		
MP7140	88.8	(Al,Ti)N-Ti	Mince						

1) Dureté nominale du substrat.

Pour les aciers et inox

MC7020

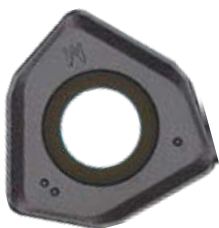

La couche d'Al₂O₃ à micrograins et la couche de TiCN texturée assurent une excellente résistance à l'usure en usinage à haute vitesse. Un substrat carbure spécifique augmente la résistance à l'écaillage et à la fissuration thermique. Cette combinaison assure performance, fiabilité et durée de vie de la nuance MC7020.

Pour l'usinage des alliages d'acier inox

MP7030

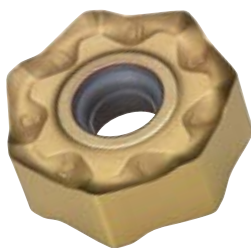

MP7030 est doté d'un revêtement multicouche basé sur un nouveau composé Ti. Il assure une résistance améliorée à l'écaillage et à l'usure lors de l'usinage d'aciers inoxydables. Un substrat en carbure tenace est particulièrement efficace pour l'usinage de matières difficiles à usiner comme l'acier inoxydable.

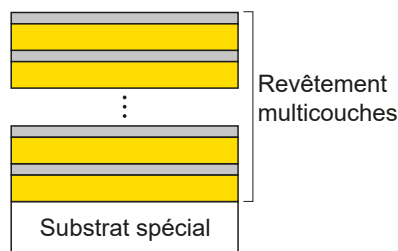

Alliages réfractaires et titane

MP9130



Un substrat optimisé en carbure ultrafin a permis d'augmenter la ténacité tout en conservant la dureté. Le revêtement multi-couches Al-Ti-Cr-N assure une résistance optimale à la chaleur et à l'usure. L'association de ces propriétés offre une excellente résistance à l'écaillage et au collage grâce au faible coefficient de friction lors de l'usinage d'alliages de titane.

NEW

MP9140



Le nouveau revêtement Al-AlTiN assure la stabilité thermique du revêtement pour une excellente résistance à l'usure en cratère et en dépouille ainsi qu'au collage.

CERMET

- NX2525 pour le fraisage haute vitesse.
- NX4545, MX3030 pour fraisage en général.

■ SÉLECTION FRAISAGE

PLAQUETTES DE FRAISAGE

Matière	Nuance recommandée	ISO	Gamme d'application
Acier Acier Inoxydable	NX2525	P	
	MX3030 NX4545	M	
Fonte	NX2525	K	
	MX3030	K	

1) Pour le fraisage sous arrosage, veuillez utiliser la nuance carbure MP6120 pour l'acier et la nuance carbure MC5020 pour la fonte.

■ CARACTÉRISTIQUES DES NUANCES

Nuance	Dureté (HRA)
NX2525	92.2
MX3030	90.0
NX4545	90.0

1) Dureté nominale du substrat

CARBURE NON-REVÊTU

● Les nuances disponibles sont : UTi20T pour les aciers et les fontes, et HTi10 pour les fontes, matières non-ferreuses et composites.

■ SÉLECTION FRAISAGE

Matière	Nuance recommandée	ISO	Gamme d'application
P Acier	UTi20T	10	
		20	
		30	UTi20T
M Acier inoxydable	UTi20T	10	
		20	
		30	UTi20T
K Fonte	HTi05T	10	HTi05T
	HTi10	20	HTi10
	UTi20T	30	UTi20T
N Métaux non-ferreux	HTi10	10	HTi10
	TF15	20	
		30	TF15

PLAQUETTES DE FRAISAGE

■ COMPOSITION ET APPLICATION

ISO	Composant principal	Caratéristiques	Matière
P / M	WC-TiC-TaC-Co	Résistance thermique / à la déformation.	Acier carbone, acier allié, acier inoxydable et fonte
K / N	WC-Co	Haute rigidité et résistance à l'usure.	Fonte, Métaux non-ferreux et composites

■ CARACTÉRISTIQUES DES NUANCES

ISO	Nuance	Dureté (HRA)
P / M	UTi20T	90.5
K / N	HTi05T	92.5
	HTi10	92.0
N	TF15	91.5

1) Dureté nominale du substrat

CBN (CBN FRITTÉ)

● MB710 et MB730 pour l'usinage des fontes.

L

■ SÉLECTION / CONDITIONS DE COUPE RECOMMANDÉES

FINITION

Matière		Structure	Vitesse de coupe (m/min)					Avance (mm/dent)	Profondeur de Passe (mm)	Arrosage
			250	500	750	1000	1250			
Fonte grise	DIN GG25	Ferritique + Perlitique	MB710					-0.3	-0.5	Sans
	DIN GG30	Perlitique								

■ CARACTÉRISTIQUES ET RECOMMANDATIONS

Nuance	Application	Caractéristiques	Composant principal	Revêtement
MB710	Pour coupe générale	Nuance générale : bon équilibre entre résistance à l'usure et à l'écaillage.	CBN TiC Al ₂ O ₃	-

PLAQUETTES DE FRAISAGE

PCD (DIAMANT FRITTÉ)

- Recommandé pour l'usinage des matériaux non ferreux et des alliages aluminium.
- Recommandé à la finition à très grande vitesse.

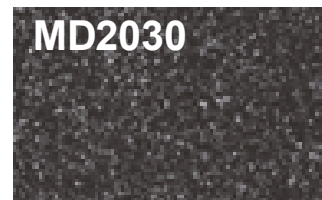
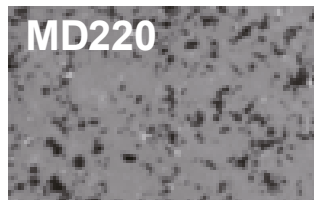

■ PARTICULARITÉ DE LA NUANCE

Nuance	Caractéristiques
MD220	Excellent équilibre entre la résistance à l'usure et la résistance à l'écaillage. Pour un choix varié de type d'usinages.
MD2030	Ténacité augmentée pour une meilleure résistance à l'écaillage dans les applications instables. La grande résistance à l'écaillage permet une utilisation polyvalente et multi-matières.

■ CONDITIONS DE COUPE RECOMMANDÉES

Matière	Vitesse de coupe (m/min)	Nuance	Avance par dent (mm/dent)	Profondeur de Passe (mm)
Alliage Aluminium (Si ≤12%)	2000—3000	MD2030 MD220	—0.2	—3.0
Alliage Aluminium (Si ≥13%)	400—800			

■ PERFORMANCE DE COUPE

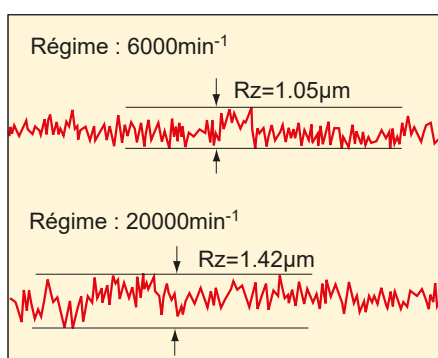
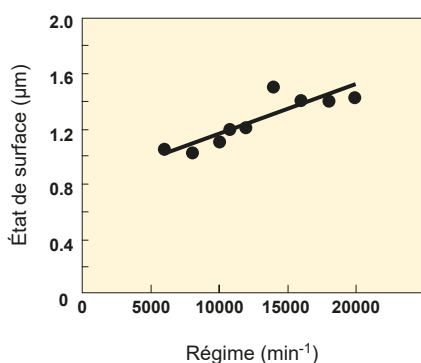

<Conditions de Coupe>







Matière : Alliage Aluminium
 Plaquette : NP-GDCW1240PDFR2
 Nuance : MD220
 Outil : V10000R0406D
 Avance : 0.2mm/dent
 Profondeur de Passe : 0.5mm
 Largeur de coupe : 80mm
 Usinage à sec

CLASSIFICATION

PLAQUETTES DE FRAISAGE







Fraise	Référence	Page
AHX440S 	NNMU130508ZER-L	L030
	WNEU1305ZEN4C-M	L049
AHX440S AHX475S 	NNMU130508ZEN-M NNMU130532ZEN-M	L030
	NNMU130532ZEN-R	L030
AHX640S 	WNEU2007ZEN7C-M	L049
	NNMU200708ZEN-MP NNMU200708ZEN-M	L031
	NNMU200712ZER-MM	L031
	NNMU200712ZER-L	L031
	WNEU2007ZEN7C-WP	L050

Fraise	Référence	Page
AHX640S AHX640W 	NNMU200608ZEN-MK	L031
	NNMU200608ZEN-HK	L031
	WNEU2006ZEN7C-WK	L050
AJX 	JOMT06T215ZZSR-JM JOMT080320ZZSR-JM JDMT09T320ZDSR-JM JDMT120420ZDSR-JM JDMT140520ZDSR-JM	L024
	JOMW06T215ZZSR-FT JOMW080320ZZSR-FT JDMW09T320ZDSR-FT JDMW120420ZDSR-FT JDMW140520ZDSR-FT	L024
	JOMT06T216ZZER-JL JOMT080322ZZER-JL JDMT09T323ZDER-JL JDMT120423ZDER-JL JDMT140523ZDER-JL	L024
	JDMT120420ZDSR-ST JDMT140520ZDSR-ST	L024
APX3000 	AOGT123602PEFR-GM AOGT123604PEFR-GM AOGT123608PEFR-GM	L022
	AOMT123602PEER-M AOMT123604PEER-M AOMT123608PEER-M AOMT123610PEER-M AOMT123612PEER-M AOMT123616PEER-M AOMT123620PEER-M AOMT123624PEER-M AOMT123630PEER-M AOMT123632PEER-M	L022

Fraise	Référence	Page
APX3000 	AOMT123604PEER-H AOMT123608PEER-H AOMT123616PEER-H	L022
APX4000 	AOMT184804PEER-M AOMT184808PEER-M AOMT184810PEER-M AOMT184812PEER-M AOMT184816PEER-M AOMT184820PEER-M	L022
	AOMT184804PEER-H AOMT184808PEER-H AOMT184816PEER-H AOMT184832PEER-H AOMT184840PEER-H AOMT184850PEER-H AOMT184864PEER-H	L022
AQX 	QOGT0830R-G1 QOGT1035R-G1 QOGT1342R-G1 QOGT1651R-G1 QOGT1856R-G1 QOGT2062R-G1 QOGT2576R-G1	L032
	QOMT0830R-M2 QOMT1035R-M2 QOMT1342R-M2 QOMT1651R-M2 QOMT1856R-M2 QOMT2062R-M2 QOMT2576R-M2	L032
ARP5/6 	RPHT1040M0E4-L RPHT1248M0E4-L RPHT1040M0E4-M RPHT1248M0E4-M RPHT1040M0E4-R RPHT1248M0E4-R	L034









Fraise	Référence	Page
	RPMT1040M0E4-L	L034
	NEW RPMT1040M0E8-L1	
	NEW RPMT1040M0E4-L2	
	RPMT1248M0E4-L	
	NEW RPMT1248M0E8-L1	
	NEW RPMT1248M0E4-L2	
	RPMT1040M0E4-M	
	NEW RPMT1040M0E8-M1	
	NEW RPMT1040M0E4-M2	
	RPMT1248M0E4-M	
	NEW RPMT1248M0E8-M1	
	NEW RPMT1248M0E4-M2	
	RPMT1040M0E4-R	
NEW RPMT1040M0E8-R1		
RPMT1248M0E4-R		
NEW RPMT1248M0E8-R1		
	JPGX1404080PPER-JM	L025
	JPGX1404120PPER-JM	
	JPGX1404160PPER-JM	
	JPGX1404240PPER-JM	
	JPGX1404320PPER-JM	
	JPGX1404400PPER-JM	
	JPGX1404500PPER-JM	
	JPGX1404635PPER-JM	
	SPGX1204100PPER-JM	L040

Fraise	Référence	Page
	SOMT12T308PEER-JH	L038
	SOMT12T320PEER-FT	L038
	WOEW12T308PEER8C	L050
	WOEW12T308PETR8C	
	SEGT13T3AGFN-JP	L036
	SEET13T3AGEN-JL	L036
	SEMT13T3AGSN-JM	L037
	SEMT13T3AGSN-JH	L037
	SEMT13T3AGSN-FT	L036
	WEEW13T3AGFR3C	L052
	WEEW13T3AGTR3C	
	WEEW13T3AGER8C	L049
	WEEW13T3AGTR8C	

Fraise	Référence	Page
	XDGX175004PDFR-GL	L046
	XDGX175008PDFR-GL	
	XDGX175012PDFR-GL	
	XDGX175016PDFR-GL	
	XDGX175020PDFR-GL	
	XDGX175024PDFR-GL	
	XDGX175030PDFR-GL	
	XDGX175032PDFR-GL	
	XDGX175040PDFR-GL	
	XDGX175050PDFR-GL	
	XDGX175004PDER-GM	L046
	XDGX175008PDER-GM	
	XDGX175012PDER-GM	
	XDGX175016PDER-GM	
	XDGX175020PDER-GM	
	XDGX175024PDER-GM	
	XDGX175030PDER-GM	
	XDGX175032PDER-GM	
	XDGX175040PDER-GM	
	XDGX175050PDER-GM	
	XDGX175004PDFR-GM	L046
	XDGX175008PDFR-GM	
	XDGX175012PDFR-GM	
	XDGX175016PDFR-GM	
	XDGX175020PDFR-GM	
	XDGX175024PDFR-GM	
	XDGX175030PDFR-GM	
	XDGX175032PDFR-GM	
	XDGX175040PDFR-GM	
	XDGX175050PDFR-GM	
	XDGX227008PDFR-GL	L046
	XDGX227016PDFR-GL	
	XDGX227020PDFR-GL	
	XDGX227030PDFR-GL	
	XDGX227032PDFR-GL	
	XDGX227040PDFR-GL	
	AEMW150304ER	L023
	AEMW150308ER	
	AEMW19T304ER	
	AEMW19T308ER	
	APGT1135PDFR-G2	L023

CLASSIFICATION







PLAQUETTES DE FRAISAGE







Fraise	Référence	Page
	APMT1135PDER-M0	L023
	APMT1135PDER-M1	
	APMT1135PDER-M2	
	APMT1135PDER-H1	L023
	APMT1135PDER-H2	
	APMT1135PDER-H3	
	APMT1135PDER-H4	
	APMT1135PDER-H6	
	APGT1604PDFR-G2	L023
	APMT1604PDER-M2	L023
	APMT1604PDER-H1	L023
	APMT1604PDER-H2	
	APMT1604PDER-H4	
	APMT1604PDER-H6	
	APMT1604PDER-H8	
	SFAN1203ZFFR2	L037
	SFAN1203ZFFL2	
	SFCN1203ZFFR2	
	SNC43B2S	L037
	SNMF43B2G	L037

Fraise	Référence	Page
	RPMT08T2M0E-JS	L034
	RPMT10T3M0E-JS	
	RPMT1204M0E-JS	
	RPMT1606M0E-JS	
	RPMW08T2M0E	L034
	RPMW08T2M0T	
	RPMW10T3M0E	
	RPMW10T3M0T	
	RPMW1204M0E	
	RPMW1204M0T	
	RPMW1606M0E	
	RPMW1606M0T	
	SPMB1204APT	L040
	JPMT060204-E	L025
	MPMT070308	L030
	MPMT090308	
	MPMT120408	
	SPMW090304	L040
	SPMW090308	
	SPMW120304	
	SPMW120308	
	CCMX083508EN-A	L024
	CCMX09T308EN-A	

Fraise	Référence	Page
	CCMX09T308EN-B	L024
	ZCMX083508ER-A	L048
	ZCMX09T308ER-A	
	ZCMX09T308ER-B	L048
	SPEN1203EEER1	L039
	SPEN1203EEEL1	
	SPNN1203EEER1	
	SPNN1203EEEL1	
	SPER1203EEER-JS	L039
	SPEN1203EETR1	L051
	WPC42EEER10C	L050
	SPCA53Z	L039
	SPCG53Z	L039

Fraise	Référence	Page
FMAX 	GOER1404PXFR2 GOER1408PXFR2	L051
	GOER1408PXFR2-8	L051
NEW 		L051
	GOER1401ZXFR2	L051
		L051
NEW 	NP-GOEN1404PXSR05 NP-GOEN1408PXSR05	L051
FP490 	SPEN424A	L039
LSE445 SE445 	SEEN1203AFEN1 SEEN1203AFTN1 SEEN1203AFTN3	L035
	SEER1203AFEN-JS	L035
NSE300 SE300 	TECN1603PEFR1W TECN1603PEER1W TECN1603PETR1W	L044



Fraise	Référence	Page
NSE300 SE300 	TECN1603PEFR1	L051
		L051
	TEEN1603PEFR1 TEEN1603PEER1 TEEN1603PETR1 TEEN1603PESR1 TEEN1603PEZR1	L044
		L044
	NSE300 TEER1603PEER-JS	L044
		L044
	NSE400 TEER2204PEER-JS	L044
		L044
	NSE400 SE400	L044
	TECN2204PEFR1 TECN2204PEER1 TECN2204PETR1 TEEN2204PEFR1 TEEN2204PEER1 TEEN2204PETR1 TEEN2204PESR1	L044
		L044
		L044
		L044
		L044
		L044
		L044
		L044
OCTACUT 	OEMX12T3ETR1 OEMX12T3ESR1 OEMX1705ETR1 OEMX1705ESR1	L031
		L031
	OEMX12T3EER1-JS OEMX1705EER1-JS OEMX1705ETR1-JS	L031
		L031
		L031
		L031
	REMX1705SN	L033
		L033

Fraise	Référence	Page
OCTACUT 	REMX12T3EN-JS REMX1705EN-JS	L033
		L033
PMF 	TPEW1303ZPER2	L045
		L045
	TPEW1303ZPTR2	L052
		L052
RRD 	RDHX0501M0E RDHX0501M0S RDHX07T1M0E RDHX07T1M0S RDHX0702M0E RDHX0702M0S RDHX1003M0E RDHX1003M0S	L032
		L032
		L032
		L032
		L032
		L032
		L032
		L032
		L032
		L032
	RDHX12T3M0E RDHX12T3M0S RDHX1604M0E RDHX1604M0S	L032
		L032
		L032
		L032
		L032
		L032
		L032
		L032
		L032
		L032
	RDMX07T1M0E RDMX07T1M0T RDMX0702M0E RDMX0702M0T RDMX1003M0E RDMX1003M0S RDMX1003M0T RDMX12T3M0E RDMX12T3M0S RDMX12T3M0T RDMX1604M0E RDMX1604M0S RDMX1604M0T	L033
		L033
		L033
		L033
		L033
		L033
		L033
		L033
		L033
		L033



CLASSIFICATION

PLAQUETTES DE FRAISAGE

Fraise	Référence	Page	Fraise	Référence	Page	Fraise	Référence	Page		
	RDZX0501M0E	L033		SEEN1504AFEN1	L035		SRBT10	L042		
	RDZX07T1M0E			SEEN1504AFTN1			SRBT12			
	RDZX0702M0E			SEEN1504AFTN3			SRBT16			
	RDZX1003M0E			SEEN1504AFSN1			SRBT20			
	RDZX1003M0S		SEER1504AFEN-JS	SRBT25						
	RDZX12T3M0E			L035	SRBT30					
	RDZX12T3M0S				SRBT32					
	RDZX1604M0E				SRF		SRFT10			
RDZX1604M0S	SRFT12	L042								
	SRFT16									
	SRFT20									
	CPMT1205ZPEN-M2		L024		WEC53AFTR5C	L049		SRFT25	L042	
	CPMT1205ZPEN-M3									
	CPMT1906ZPEN-M2									
	CPMT1906ZPEN-M3									
	SEEN1203EFFR1	L035		RGEN2004M0EN	L033		SRG16C	L042		
	SEEN1203EFER1			RGEN2004M0SN						
	SEEN1203EFTR1		JPMX140412-JM		JPMX190412-JM		L025			SRG20C
	SEEN1203EFTR3				JPMX140412-WH					
	SEEN1203EFSR1				JPMX190412-WH					
	SEER1203EFER-JS		JPMX140412-WH	L025		SRG25C				
			JPMX190412-WH							
	SEER1203EFER-JS	L036		MPMX120412-JM	L030		SRG30C	L043		
							JPMX120412-WH			
	SECN1203EFFR1	L051		MPMX120412-WH	L030		SRG32C	L043		
	WEC42EFTR5C	L049		SPMX120408-JM	L041		SRG40C	L042		
	SECN1504EFTR1	L036		SPMX120408-WH	L041		SRG50C	L042		
	SEEN1504EFER1									
	SEEN1504EFTR1	L049					SRG40E	L042		
	SEEN1504EFSR1									
	WEC53EFTR5C	L049					SRG50E	L042		
							APMT1135PDER-M2	L023		
							APMT1604PDER-M2			















Fraise	Référence	Page
SRM2 ϕ 40 ϕ 50 	APMT1135PDER-H2	L023
	APMT1604PDER-H2	
SUF 	SUFT10R05	L043
	SUFT10R10	
	SUFT10R20	
	SUFT12R05	
	SUFT12R10	
	SUFT12R20	
	SUFT12R30	
	SUFT16R05	
	SUFT16R10	
	SUFT16R15	
	SUFT16R20	
	SUFT16R30	
	SUFT20R05	
	SUFT20R10	
	SUFT20R15	
	SUFT20R20	
	SUFT20R30	
	SUFT25R05	
	SUFT25R10	
	SUFT25R20	
	SUFT25R30	
	SUFT30R05	
	SUFT30R10	
	SUFT30R20	
	SUFT30R30	
	SUFT32R05	
	SUFT32R10	
	SUFT32R20	

Fraise	Référence	Page
DCV3 Fraise 3 tailles 	LNGU090604PNER-M	L026
	LNGU090604PNEL-M	
	LNGU090608PNER-M	
	LNGU090608PNEL-M	
	LNGU090612PNER-M	
	LNGU090612PNEL-M	
	LNGU090616PNER-M	
	LNGU090616PNEL-M	
	LNGU090620PNER-M	
	LNGU090620PNEL-M	
	LNGU090624PNER-M	
	LNGU090624PNEL-M	
	LNGU090630PNER-M	
	LNGU090630PNEL-M	
	LNGU090640PNER-M	
LNGU090640PNEL-M		
DCV4 Fraise 3 tailles 	LNGU130804PNER-M	L026
	LNGU130804PNEL-M	
	LNGU130808PNER-M	
	LNGU130808PNEL-M	
	LNGU130820PNER-M	
	LNGU130820PNEL-M	
	LNGU130830PNER-M	
	LNGU130830PNEL-M	
	LNGU130840PNER-M	
	LNGU130840PNEL-M	
NEW 	LNGU130804PNER-R	L026
	LNGU130804PNEL-R	
	LNGU130808PNER-R	
	LNGU130808PNEL-R	
	LNGU130812PNER-R	
	LNGU130812PNEL-R	
	LNGU130816PNER-R	
	LNGU130816PNEL-R	
	LNGU130820PNER-R	
	LNGU130820PNEL-R	
	LNGU130824PNER-R	
	LNGU130824PNEL-R	
	LNGU130830PNER-R	
	LNGU130830PNEL-R	
	LNGU130840PNER-R	
LNGU130840PNEL-R		
LNGU130850PNER-R		
LNGU130850PNEL-R		

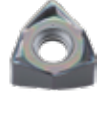
Fraise	Référence	Page
DCV4 Fraise 3 tailles 	LNGU171004PNER-R	L027
	LNGU171004PNEL-R	
	LNGU171008PNER-R	
	LNGU171008PNEL-R	
	LNGU171012PNER-R	
	LNGU171012PNEL-R	
	LNGU171016PNER-R	
	LNGU171016PNEL-R	
	LNGU171020PNER-R	
	LNGU171020PNEL-R	
	LNGU171024PNER-R	
	LNGU171024PNEL-R	
	LNGU171030PNER-R	
	LNGU171030PNEL-R	
	LNGU171040PNER-R	
LNGU171040PNEL-R		
LNGU171050PNER-R		
LNGU171050PNEL-R		
LNGU171060PNER-R		
LNGU171060PNEL-R		
LNGU171070PNER-R		
LNGU171070PNEL-R		
VPX200 	LOGU0904020PNER-L	L028
	LOGU0904040PNER-L	
	LOGU0904080PNER-L	
	LOGU0904100PNER-L	
	LOGU0904120PNER-L	
	LOGU0904160PNER-L	
	LOGU0904020PNFR-L	
	LOGU0904040PNFR-L	
	LOGU0904080PNFR-L	
	LOGU0904100PNFR-L	
LOGU0904160PNFR-L		
NEW 	LOGU0904020PNER-M	L028
	LOGU0904040PNER-M	
	LOGU0904080PNER-M	
	LOGU0904100PNER-M	
	LOGU0904120PNER-M	
	LOGU0904160PNER-M	
	LOGU0904020PNFR-M	
	LOGU0904040PNFR-M	
	LOGU0904080PNFR-M	
	LOGU0904100PNFR-M	
LOGU0904120PNFR-M		
LOGU0904160PNFR-M		

CLASSIFICATION

PLAQUETTES DE FRAISAGE

Fraise	Référence	Page	Fraise	Référence	Page	Fraise	Référence	Page	
	LOGU1207020PNER-L	L029		XNMU160708R-MS	L047		NEW JOMU090512ZZER-L	L025	
	LOGU1207040PNER-L			XNMU160712R-MS			NEW JOMU140715ZZER-L		
	LOGU1207080PNER-L			XNMU160716R-MS			NEW JOMU090512ZZER-M		
	LOGU1207100PNER-L			XNMU160724R-MS			JOMU140715ZZER-M		
	LOGU1207120PNER-L			XNMU160732R-MS			NEW JOMU090512ZZER-R		
	LOGU1207160PNER-L			XNMU160740R-MS			NEW JOMU140715ZZER-R		
	LOGU1207200PNER-L			XNMU160708R-HS					
	LOGU1207240PNER-L								
	LOGU1207300PNER-L								
	LOGU1207320PNER-L								
	LOGU1207020PNFR-L								
	LOGU1207040PNFR-L		XNMU160708R-LS						
	LOGU1207080PNFR-L								
	LOGU1207100PNFR-L								
	LOGU1207120PNFR-L								
	LOGU1207160PNFR-L								
	LOGU1207200PNFR-L								
	LOGU1207240PNFR-L								
	LOGU1207300PNFR-L								
	LOGU1207320PNFR-L								
	LOGU1207020PNER-M	L029		XNMU190912R-MS	L047		SNGU140812ANFR-L	L037	
	LOGU1207040PNER-M			XNMU190916R-MS			SNGU140812ANFL-L		
	LOGU1207080PNER-M			XNMU190924R-MS			SNGU140812ANER-L		
	LOGU1207100PNER-M			XNMU190932R-MS			SNGU140812ANEL-L		
	LOGU1207120PNER-M			XNMU190940R-MS			SNGU140812ANER-M		
	LOGU1207160PNER-M			XNMU190950R-MS			SNGU140812ANEL-M		
	LOGU1207200PNER-M			XNMU190912R-HS			SNMU140812ANER-M		
	LOGU1207240PNER-M			SNMU140812ANER-R					
	LOGU1207300PNER-M			SNMU140812ANER-R					
	LOGU1207320PNER-M			SNMU140812ANER-H					
	LOGU1207020PNFR-M								
	LOGU1207040PNFR-M								
	LOGU1207080PNFR-M								
	LOGU1207100PNFR-M								
	LOGU1207120PNFR-M								
	LOGU1207160PNFR-M								
	LOGU1207200PNFR-M								
	LOGU1207240PNFR-M								
	LOGU1207300PNFR-M								
	LOGU1207320PNFR-M								
		L029		SONX1206PER	L038		6NGU1409040PNER-L	L022	
				SONX1206PEL			6NGU1409080PNER-L		
					6NGU1409040PNFR-L				
					6NGU1409080PNFR-L				
					6NMU1409040PNER-M				
					6NMU1409080PNER-M				
					6NMU1409080PNER-R				
		L029		TPNX1605N	L045		TPEN1603PPR	L045	
							TPEN1603PPN		
							TPEN2204PDR		L045
							SPEN1203EDR		
							SPEN1203EDL	L039	
							SPEN1504EDR		
							SPEN1504EDL	L041	
							SPNN1203EDR		

Fraise	Référence	Page
Angle d'attaque 45° 15° Positive 	SDEN1203AEN	L035
Angle d'attaque 45° 20° Positive 	SEER1204AFEN-JS	L035
	SEEW1204AFTN	L036
	SEMN1204AZTN	L036
Négatives 	SNEN1204EN SNEN1504EN	L037
	SNMN120408 SNMN120412	L038
11° Positive 	SPGN120304	L040
	SPGN120308	
	SPGN120312	
	SPGN150404	
	SPGN150408	
	SPMN120304	
	SPMN120304T	
	SPMN120308	
	SPMN120312	
	SPMN120408	
	SPMN120412	
	SPMN150408 SPMN150412	

Fraise	Référence	Page
11° Positive 	TPMN160304	L045
	TPMN160308	
	TPMN160312	
	TPMN220404	
	TPMN220408	
	TPMN220408T TPMN220412	

PLAQUETTES DE FRAISAGE

PLAQUETTES DE FRAISAGE

Forme	Référence	Classe	Honing	Revêtu								Carbure	Dimensions (mm)						Géométrie				
				MC5020	MP6120	MP6130	MP7130	MP9120	MP9130	VP15TF	VP20RT	TF15	L	LE	W1	S	BS	RE					
Matière P Acier M Acier Inoxydable K Fonte N Non-ferreux S Alliage réfractaire, Alliage titane H Matières traitées / trempées												Conditions de coupe (Guide): ● : Coupe Stable ● : Coupe Générale ✖ : Coupe Instable Honing: E : Arrondie F : Vive											
WWX400 ↻K056 NEW 	6NGU1409040PNER-L	G	E	★	★	★	●	●	●	●	●	●	●			-	-	-	7	1.7	0.4		
	6NGU1409080PNER-L	G	E	★	●	●	●	●	●	●	●	●	●	●			-	-	-	7	1.3		0.8
	6NGU1409040PNFR-L	G	F												●		-	-	-	7	1.7		0.4
	6NGU1409080PNFR-L	G	F												●		-	-	-	7	1.3		0.8
	6NMU1409040PNER-M	M	E	●	●	●	●	●	●	●	●	●	●	●			-	-	-	7	1.7		0.4
	6NMU1409080PNER-M	M	E	●	●	●	●	●	●	●	●	●	●	●			-	-	-	7	1.3		0.8
	6NMU1409080PNER-R	M	E	●	●	●		●	●	●	●	●	●	●			-	-	-	7	1.3		0.8
APX3000 ↻K133 APX3000 Série longue ↻K147 	AOGT123602PEFR-GM	G	F											●		12	10	6.6	3.6	1.8	0.2		
	AOGT123604PEFR-GM	G	F											●		12	10	6.6	3.6	1.6	0.4		
	AOGT123608PEFR-GM	G	F											●		12	10	6.6	3.6	1.2	0.8		
APX3000 ↻K133 APX3000 Série longue ↻K147 	AOAMT123604PEER-H	M	E	●	●	●	●	●	●	●	●	●	●			12	10	6.6	3.6	1.6	0.4		
	AOAMT123608PEER-H	M	E	●	●	●	●	●	●	●	●	●	●			12	10	6.6	3.6	1.2	0.8		
	AOAMT123616PEER-H	M	E	●	●	●	●	●	●	●	●	●	●			12	10	6.6	3.6	0.4	1.6		
APX3000 ↻K133 APX3000 Série longue ↻K147 	AOAMT123602PEER-M	M	E	●	●	●	●	●	●	●	●	●	●			12	10	6.6	3.6	1.8	0.2		
	AOAMT123604PEER-M	M	E	●	●	●	●	●	●	●	●	●	●			12	10	6.6	3.6	1.6	0.4		
	AOAMT123608PEER-M	M	E	●	●	●	●	●	●	●	●	●	●			12	10	6.6	3.6	1.2	0.8		
	AOAMT123610PEER-M	M	E	●	●	●	●	●	●	●	●	●	●			12	10	6.6	3.6	1.0	1.0		
	AOAMT123612PEER-M	M	E	●	●	●	●	●	●	●	●	●	●			12	10	6.6	3.6	0.8	1.2		
	AOAMT123616PEER-M	M	E	●	●	●	●	●	●	●	●	●	●			12	10	6.6	3.6	0.4	1.6		
	AOAMT123620PEER-M	M	E	●	●	●	●	●	●	●	●	●	●			12	10	6.6	3.6	0.4	2.0		
	AOAMT123624PEER-M	M	E	●	●	●	●	●	●	●	●	●	●			12	10	6.6	3.6	0.4	2.4		
	AOAMT123630PEER-M	M	E	●	●	●	●	●	●	●	●	●	●			12	10	6.6	3.6	0.4	3.0		
AOAMT123632PEER-M	M	E	●	●	●	●	●	●	●	●	●	●			12	10	6.6	3.6	0.4	3.2			
APX4000 ↻K140 APX4000 Série longue ↻K151 	AOAMT184804PEER-H	M	E	●	●	●	●	●	●	●	●	●	●			18	15	9	4.8	1.8	0.4		
	AOAMT184808PEER-H	M	E	●	●	●	●	●	●	●	●	●	●			18	15	9	4.8	1.4	0.8		
	AOAMT184816PEER-H	M	E	●	●	●	●	●	●	●	●	●	●			18	15	9	4.8	0.4	1.6		
	AOAMT184832PEER-H	M	E		●	●							●				18	15	9	4.8	0.4		3.2
	AOAMT184840PEER-H	M	E		●	●							●				18	15	9	4.8	0.4		4.0
	AOAMT184850PEER-H	M	E		●	●							●				18	15	9	4.8	-		5.0
	AOAMT184864PEER-H	M	E		●	●							●				18	15	9	4.8	-		6.35
APX4000 ↻K140 APX4000 Série longue ↻K151 	AOAMT184804PEER-M	M	E	●	●	●	●	●	●	●	●	●	●			18	15	9	4.8	1.8	0.4		
	AOAMT184808PEER-M	M	E	●	●	●	●	●	●	●	●	●	●			18	15	9	4.8	1.4	0.8		
	AOAMT184810PEER-M	M	E	●				●	●	●	●	●	●			18	15	9	4.8	1.0	1.0		
	AOAMT184812PEER-M	M	E	●				●	●	●	●	●	●			18	15	9	4.8	0.8	1.2		
	AOAMT184816PEER-M	M	E	●	●	●	●	●	●	●	●	●	●			18	15	9	4.8	0.4	1.6		
	AOAMT184820PEER-M	M	E	●				●	●	●	●	●	●			18	15	9	4.8	0.4	2.0		











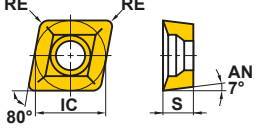

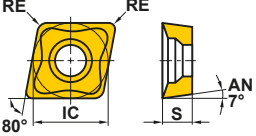
● : Article stocké. ★ : Article standard Japon.
 (10 plaquettes par boîte)

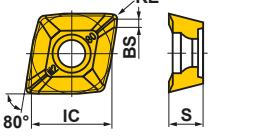

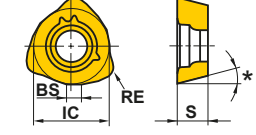
Matière	P	Acier	●	●	●	●	●	Conditions de coupe (Guide): ●: Coupe Stable ●: Coupe Générale ✖: Coupe Instable																				
	M	Acier Inoxydable	●	●	●	●	●																					
	K	Fonte	✖	●	●	●	●																					
Forme	N	Non-ferreux	●	●	●	●	●	Honing: E: Arrondie F: Vive																				
	S	Alliage réfractaire, Alliage titane	●	●	●	●	●																					
	H	Matières traitées / trempées	●	●	●	●	●																					
Forme	Référence	Classe	Honing	Revêtu						Cermet						Carbure						Dimensions (mm)						Géométrie
				F7030	VP15TF	UP20M	NX2525	NX4545	UT120T	HT10	L	LE	W1	S	BS	RE												
	BAE	AEMW150304ER	M	E				★	●	●						16.696	15.2	9.525	3.18	—	0.4							
		AEMW150308ER	M	E				★	★	●						16.623	14.8	9.525	3.18	—	0.8							
		AEMW19T304ER	M	E				★	●							20.161	18.4	12.7	3.97	—	0.4							
		AEMW19T308ER	M	E				★	★							20.088	18.0	12.7	3.97	—	0.8							
	BAP300	APGT1135PDR-G2	G	F												11.3	9.7	6.35	3.5	1.2	0.8							
	BAP400	APGT1604PDR-G2	G	F												17.02	14	9.525	4.76	1.4	0.8							
	BAP300	APMT1135PDER-H1	M	E	●	●		●	★	●						11.25	9	6.35	3.5	1.5	0.4							
	SRM2	APMT1135PDER-H2	M	E	●	●		●	●	●						11.25	9	6.35	3.5	1.2	0.8							
	Ⓚ220	APMT1135PDER-H3	M	E	●											11.26	9	6.35	3.5	0.8	1.2							
		APMT1135PDER-H4	M	E	●											11.24	9	6.35	3.5	0.4	1.6							
		APMT1135PDER-H6	M	E	●											11.10	9	6.35	3.5	0.4	2.4							
	BAP400	APMT1604PDER-H1	M	E	●			●		●						17.02	14	9.525	4.76	1.7	0.4							
	SRM2	APMT1604PDER-H2	M	E	●	●		●	●	●						17.11	14	9.525	4.76	1.4	0.8							
	Ⓚ220	APMT1604PDER-H4	M	E	●											17.06	14	9.525	4.76	0.4	1.6							
	SRM2φ40	APMT1604PDER-H6	M	E	●											16.93	14	9.525	4.76	0.4	2.4							
	φ50	APMT1604PDER-H8	M	E	●											16.79	14	9.525	4.76	0.4	3.2							
	BAP300	APMT1135PDER-M0	M	E	★											11.25	9	6.35	3.5	1.8	0.2							
	SRM2	APMT1135PDER-M1	M	E	★											11.25	9	6.35	3.5	1.5	0.4							
	Ⓚ220	APMT1135PDER-M2	M	E	●	●		●								11.18	9	6.35	3.5	1.2	0.8							
	BAP400	APMT1604PDER-M2	M	E	●	●		●								17.10	14	9.525	4.76	1.4	0.8							
	SRM2																											
Ⓚ220																												
SRM2φ40																												
φ50																												
Ⓚ228																												

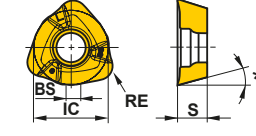
PLAQUETTES DE FRAISAGE

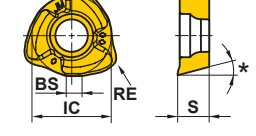
PLAQUETTES DE FRAISAGE

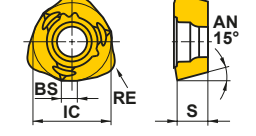
Matière	P	Acier	●	●	●	●	●	●	●	●	●	●	●	Conditions de coupe (Guide): ●: Coupe Stable ●: Coupe Générale ✖: Coupe Instable								
	M	Acier Inoxydable	●	●	●	●	●	●	●	●	●	●	●									
Matière	K	Fonte	●	●	●	●	●	●	●	●	●	●	●	Honing: E: Arrondie S: Chanfrein + Rayon								
	N	Non-ferreux	●	●	●	●	●	●	●	●	●	●	●									
	S	Alliage réfractaire, Alliage titane	●	●	●	●	●	●	●	●	●	●	●									
Forme	Référence	Classe	Honing	Revêtu								Carbure	Dimensions (mm)				Géométrie					
				F7030	FH7020	MP6120	MP6130	MP7130	MP7140	MP9120	MP9130	MP9140	NEW	VP15TF	VP30RT	UP20M		UTi20T	IC	S	BS	RE
	DCCC K200	CCMX083508EN-A	M	E	●										★	★	7.94	3.5	—	0.8		
		CCMX09T308EN-A	M	E	●											●	★	9.525	3.97	—		0.8
	DCCC K200	CCMX09T308EN-B	M	E	●											★	9.525	3.97	—	0.8		
	PMR K236	CPMT1205ZPEN-M2	M	E												●	12.7	5.56	1.4	0.8		
		CPMT1205ZPEN-M3	M	E													★	12.7	5.56	1.4		1.2
		CPMT1906ZPEN-M2	M	E													●	19.05	6.35	1.4		0.8
		CPMT1906ZPEN-M3	M	E													★	19.05	6.35	1.4		1.2
	AJX K180	JOMW06T215ZZSR-FT	M	S	●	●	●	●	●	●	●	●	●	●	●	●	6.35	2.78	1.2	1.5		
		JOMW080320ZZSR-FT	M	S	●	●	●	●	●	●	●	●	●	●	●	●	8	3.18	1.4	2		
		JDMW09T320ZDSR-FT	M	S	●	●	●	●	●	●	●	●	●	●	●	●	9.525	3.97	1.8	2		
		JDMW120420ZDSR-FT	M	S	●	●	●	●	●	●	●	●	●	●	●	●	12	4.76	2.5	2		
		JDMW140520ZDSR-FT	M	S	●	●	●	●	●	●	●	●	●	●	●	●	14	5.56	2.8	2		
*JOMW... : 13°, JDMW... : 15°																						
	AJX K180	JOMT06T216ZZER-JL	M	E												●	6.35	2.78	1.2	1.6		
		JOMT080322ZZER-JL	M	E													●	8	3.18	1.4		2.2
		JDMT09T323ZDER-JL	M	E													●	9.525	3.97	1.8		2.3
		JDMT120423ZDER-JL	M	E													●	12	4.76	2.5		2.3
		JDMT140523ZDER-JL	M	E													●	14	5.56	2.8		2.3
*JOMT... : 13°, JDMT... : 15°																						
	AJX K180	JOMT06T215ZZSR-JM	M	S	●	●	●	●	●	●	●	●	●	●	●	●	6.35	2.78	1.2	1.5		
		JOMT080320ZZSR-JM	M	S	●	●	●	●	●	●	●	●	●	●	●	●	8	3.18	1.4	2		
		JDMT09T320ZDSR-JM	M	S	●	●	●	●	●	●	●	●	●	●	●	●	9.525	3.97	1.8	2		
		JDMT120420ZDSR-JM	M	S	●	●	●	●	●	●	●	●	●	●	●	●	12	4.76	2.5	2		
		JDMT140520ZDSR-JM	M	S	●	●	●	●	●	●	●	●	●	●	●	●	14	5.56	2.8	2		
*JOMT... : 13°, JDMT... : 15°																						
	AJX K180	JDMT120420ZDSR-ST	M	S	●	●	●	●	●	●	●	●	●	●	●	●	12	4.76	2.5	2		
		JDMT140520ZDSR-ST	M	S	●	●	●	●	●	●	●	●	●	●	●	●	14	5.56	2.8	2		



● = NEW

● : Article stocké. ★ : Article standard Japon.
(10 plaquettes par boîte)

Matière	P	Acier	●	●	●	●	●	●	●	●	●	●	●	Conditions de coupe (Guide): ●: Coupe Stable ●: Coupe Générale ✖: Coupe Instable																		
	M	Acier Inoxydable	●	●	●	●	●	●	●	●	●	●	●																			
Matière	K	Fonte	●	●	●	●	●	●	●	●	●	●	●	Honing: E: Arrondie S: Chanfrein + Rayon																		
	N	Non-ferreux	●	●	●	●	●	●	●	●	●	●	●																			
	S	Alliage réfractaire, Alliage titane	●	●	●	●	●	●	●	●	●	●	●																			
Forme	Référence	Classe	Honing	Revêtu										Carbure	Dimensions (mm)						Géométrie											
				MC7020	MP6120	MP6130	MP7130	MP7140	MP9120	MP9130	NEW MP9140	VP15TF	VP20RT		VP30RT	UP20M	UTi20T	L	LE	IC		S	BS	RE								
	WJX09	JOMU090512ZZER-L	M	E	●	●	●	●	●	●	●	●	●	●	●	●	●	●	●	●	●	●	●	●								
	⊕K072	JOMU140715ZZER-L	M	E	●	●	●	●	●	●	●	●	●	●	●	●	●	●	●	●	●	●	●	●								
	⊕K079	JOMU090512ZZER-M	M	E	●	●	●	●	●	●	●	●	●	●	●	●	●	●	●	●	●	●	●	●								
		JOMU140715ZZER-M	M	E	●	●	●	●	●	●	●	●	●	●	●	●	●	●	●	●	●	●	●	●								
		JOMU090512ZZER-R	M	E	●	●	●	●	●	●	●	●	●	●	●	●	●	●	●	●	●	●	●	●								
		JOMU140715ZZER-R	M	E	●	●	●	●	●	●	●	●	●	●	●	●	●	●	●	●	●	●	●	●								
	ASPX	JPGX1404080PPER-JM	G	E																												
	⊕K208	JPGX1404120PPER-JM	G	E																												
		JPGX1404160PPER-JM	G	E																												
	NEW	JPGX1404240PPER-JM	G	E																												
		JPGX1404320PPER-JM	G	E																												
		JPGX1404400PPER-JM	G	E																												
		JPGX1404500PPER-JM	G	E																												
		JPGX1404635PPER-JM	G	E																												
	TAB	JPMT060204-E	M	E																												
	SPX	JPMX140412-JM	M	E																												
	⊕K203	JPMX190412-JM	M	E																												
	SPX	JPMX140412-WH	M	E																												
	⊕K203	JPMX190412-WH	M	E																												

● ★ = NEW

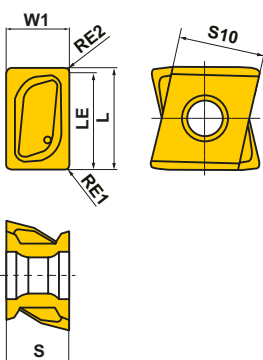
PLAQUETTES DE FRAISAGE

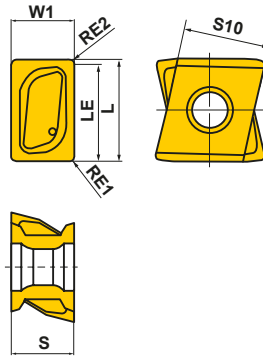
Forme	Référence	Sens	Classe	Honing	Revêtu	Dimensions (mm)							Géométrie
						L	LE	S	S10	RE1	RE2	W1	
						MP6120	VP15TF						
DCV3 Fraise 3 Tailles 	LNGU090604PNER-M	R	G	E	●	9.0	8.6	6.0	8.5	0.4	0.4	6.0	
	LNGU090604PNEL-M	L	G	E	●	9.0	8.6	6.0	8.5	0.4	0.4	6.0	
	LNGU090608PNER-M	R	G	E	●	9.0	8.6	6.0	8.5	0.8	0.4	6.0	
	LNGU090608PNEL-M	L	G	E	●	9.0	8.6	6.0	8.5	0.8	0.4	6.0	
	LNGU090612PNER-M	R	G	E	●	9.0	8.6	6.0	8.5	1.2	0.4	6.0	
	LNGU090612PNEL-M	L	G	E	●	9.0	8.6	6.0	8.5	1.2	0.4	6.0	
	LNGU090616PNER-M	R	G	E	●	9.0	8.6	6.0	8.5	1.6	0.4	6.0	
	LNGU090616PNEL-M	L	G	E	●	9.0	8.6	6.0	8.5	1.6	0.4	6.0	
	LNGU090620PNER-M	R	G	E	●	9.0	8.6	6.0	8.5	2.0	0.4	6.0	
	LNGU090620PNEL-M	L	G	E	●	9.0	8.6	6.0	8.5	2.0	0.4	6.0	
	LNGU090624PNER-M	R	G	E	●	9.0	8.6	6.0	8.5	2.4	0.4	6.0	
	LNGU090624PNEL-M	L	G	E	●	9.0	8.6	6.0	8.5	2.4	0.4	6.0	
	LNGU090630PNER-M	R	G	E	●	9.0	8.6	6.0	8.5	3.0	0.4	6.0	
	LNGU090630PNEL-M	L	G	E	●	9.0	8.6	6.0	8.5	3.0	0.4	6.0	
	LNGU090640PNER-M	R	G	E	●	9.0	8.6	6.0	8.5	4.0	0.4	6.0	
LNGU090640PNEL-M	L	G	E	●	9.0	8.6	6.0	8.5	4.0	0.4	6.0		
DCV4 Fraise 3 Tailles 	LNGU130804PNER-M	R	G	E	●	13.0	12.2	8.0	11.0	0.4	0.8	8.0	
	LNGU130804PNEL-M	L	G	E	●	13.0	12.2	8.0	11.0	0.4	0.8	8.0	
	LNGU130808PNER-M	R	G	E	●	13.0	12.2	8.0	11.0	0.8	0.8	8.0	
	LNGU130808PNEL-M	L	G	E	●	13.0	12.2	8.0	11.0	0.8	0.8	8.0	
	LNGU130820PNER-M	R	G	E	●	13.0	12.2	8.0	11.0	2.0	0.8	8.0	
	LNGU130820PNEL-M	L	G	E	●	13.0	12.2	8.0	11.0	2.0	0.8	8.0	
	LNGU130830PNER-M	R	G	E	●	13.0	11.4	8.0	11.0	3.0	1.6	8.0	
	LNGU130830PNEL-M	L	G	E	●	13.0	11.4	8.0	11.0	3.0	1.6	8.0	
	LNGU130840PNER-M	R	G	E	●	13.0	11.4	8.0	11.0	4.0	1.6	8.0	
	LNGU130840PNEL-M	L	G	E	●	13.0	11.4	8.0	11.0	4.0	1.6	8.0	
	LNGU130850PNER-M	R	G	E	●	13.0	11.4	8.0	11.0	5.0	1.6	8.0	
	LNGU130850PNEL-M	L	G	E	●	13.0	11.4	8.0	11.0	5.0	1.6	8.0	
	NEW LNGU130804PNER-R	R	G	E	●●	13.0	12.2	8.0	11.0	0.4	0.8	8.0	
	NEW LNGU130804PNEL-R	L	G	E	●●	13.0	12.2	8.0	11.0	0.4	0.8	8.0	
	NEW LNGU130808PNER-R	R	G	E	●●	13.0	12.2	8.0	11.0	0.8	0.8	8.0	
	NEW LNGU130808PNEL-R	L	G	E	●●	13.0	12.2	8.0	11.0	0.8	0.8	8.0	
	NEW LNGU130812PNER-R	R	G	E	●●	13.0	12.2	8.0	11.0	1.2	0.8	8.0	
	NEW LNGU130812PNEL-R	L	G	E	●●	13.0	12.2	8.0	11.0	1.2	0.8	8.0	
	NEW LNGU130816PNER-R	R	G	E	●●	13.0	12.2	8.0	11.0	1.6	0.8	8.0	
	NEW LNGU130816PNEL-R	L	G	E	●●	13.0	12.2	8.0	11.0	1.6	0.8	8.0	
NEW LNGU130820PNER-R	R	G	E	●●	13.0	12.2	8.0	11.0	2.0	0.8	8.0		
NEW LNGU130820PNEL-R	L	G	E	●●	13.0	12.2	8.0	11.0	2.0	0.8	8.0		

Plaquette représentée à droite.

Plaquette représentée à droite.



● = NEW

● : Article stocké.
(10 plaquettes par boîte)

PLAQUETTES DE FRAISAGE

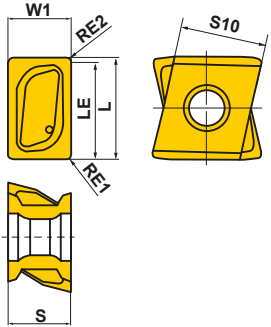

NEW

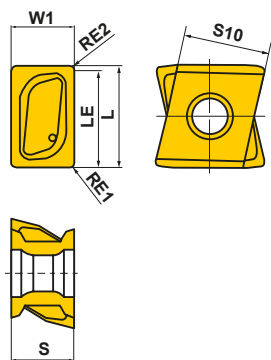
Matière	P	Acier			●	●	●	●	Conditions de coupe (Guide) : ●: Coupe Stable ●: Coupe Générale ❖: Coupe Instable				Géométrie		
	M	Acier Inoxydable													
	K	Fonte							●	●	●	●		●	●
N	Non-ferreux								Honing: E: Arrondie						
S	Alliage réfractaire, Alliage titane														
H	Acier trempé														
Forme	Référence	Sens	Classe	Honing	Revêtu		Dimensions (mm)						Géométrie		
					MP6120	VP15TF	L	LE	S	S10	RE1	RE2		W1	
DCV4 Fraise 3 Tailles 	NEW LNGU130824PNER-R	R	G	E	●	●	13.0	12.2	8.0	11.0	2.4	0.8	8.0		
	NEW LNGU130824PNEL-R	L	G	E	●	●	13.0	12.2	8.0	11.0	2.4	0.8	8.0		
	NEW LNGU130830PNER-R	R	G	E	●	●	13.0	11.4	8.0	11.0	3.0	1.6	8.0		
	NEW LNGU130830PNEL-R	L	G	E	●	●	13.0	11.4	8.0	11.0	3.0	1.6	8.0		
	NEW LNGU130840PNER-R	R	G	E	●	●	13.0	11.4	8.0	11.0	4.0	1.6	8.0		
	NEW LNGU130840PNEL-R	L	G	E	●	●	13.0	11.4	8.0	11.0	4.0	1.6	8.0		
	NEW LNGU130850PNER-R	R	G	E	●	●	13.0	11.4	8.0	11.0	5.0	1.6	8.0		
DCV5 Fraise 3 Tailles 	LNGU171004PNER-R	R	G	E	●	●	17.0	16.2	10.0	13.0	0.4	0.8	10.0		
	LNGU171004PNEL-R	L	G	E	●	●	17.0	16.2	10.0	13.0	0.4	0.8	10.0		
	LNGU171008PNER-R	R	G	E	●	●	17.0	16.2	10.0	13.0	0.8	0.8	10.0		
	LNGU171008PNEL-R	L	G	E	●	●	17.0	16.2	10.0	13.0	0.8	0.8	10.0		
	LNGU171012PNER-R	R	G	E	●	●	17.0	16.2	10.0	13.0	1.2	0.8	10.0		
	LNGU171012PNEL-R	L	G	E	●	●	17.0	16.2	10.0	13.0	1.2	0.8	10.0		
	LNGU171016PNER-R	R	G	E	●	●	17.0	16.2	10.0	13.0	1.6	0.8	10.0		
	LNGU171016PNEL-R	L	G	E	●	●	17.0	16.2	10.0	13.0	1.6	0.8	10.0		
	LNGU171020PNER-R	R	G	E	●	●	17.0	16.2	10.0	13.0	2.0	0.8	10.0		
	LNGU171020PNEL-R	L	G	E	●	●	17.0	16.2	10.0	13.0	2.0	0.8	10.0		
	LNGU171024PNER-R	R	G	E	●	●	17.0	16.2	10.0	13.0	2.4	0.8	10.0		
	LNGU171024PNEL-R	L	G	E	●	●	17.0	16.2	10.0	13.0	2.4	0.8	10.0		
	LNGU171030PNER-R	R	G	E	●	●	17.0	15.4	10.0	13.0	3.0	1.6	10.0		
	LNGU171030PNEL-R	L	G	E	●	●	17.0	15.4	10.0	13.0	3.0	1.6	10.0		
	LNGU171040PNER-R	R	G	E	●	●	17.0	15.4	10.0	13.0	4.0	1.6	10.0		
	LNGU171040PNEL-R	L	G	E	●	●	17.0	15.4	10.0	13.0	4.0	1.6	10.0		
	LNGU171050PNER-R	R	G	E	●	●	17.0	15.4	10.0	13.0	5.0	1.6	10.0		
	LNGU171050PNEL-R	L	G	E	●	●	17.0	15.4	10.0	13.0	5.0	1.6	10.0		
LNGU171060PNER-R	R	G	E	●	●	17.0	15.4	10.0	13.0	6.0	1.6	10.0			
LNGU171060PNEL-R	L	G	E	●	●	17.0	15.4	10.0	13.0	6.0	1.6	10.0			
LNGU171070PNER-R	R	G	E	●	●	17.0	15.4	10.0	13.0	7.0	1.6	10.0			
LNGU171070PNEL-R	L	G	E	●	●	17.0	15.4	10.0	13.0	7.0	1.6	10.0			

Plaquette représentée à droite.

Plaquette représentée à droite.

● = NEW

PLAQUETTES DE FRAISAGE

Matière	P	Acier	●							●		●		●		Conditions de coupe (Guide): ● : Coupe Stable ● : Coupe Générale ✖ : Coupe Instable	
	M	Acier Inoxydable	●							●		●		Honing: E : Arrondie F : Vive			
	K	Fonte	●							●		●					
Forme	N	Non-ferreux	Revêtu	Carbure	Dimensions (mm)					Géométrie							
	S	Alliage réfractaire, Alliage titane			L	RE	LE	S	BS								
	H	Acier trempé															
Référence	Classe	Honing	MC5020	MP6120	MP6130	MP7130	MP9120	MP9130	VP15TF	TF15	L	RE	LE	S	BS	Géométrie	
			VPX200 K086 VPX200 Série longue K114	LOGU0904020PNER-L	G	E	★	★	★								★
	LOGU0904040PNER-L	G	E	●	●	●	●	●	●	●	★	★	★	★	★	★	
	LOGU0904080PNER-L	G	E	●	●	●	●	●	●	●	★	★	★	★	★	★	
	LOGU0904100PNER-L	G	E	★	★	★	★	★	★	★	★	★	★	★	★	★	
	LOGU0904120PNER-L	G	E	★	★	★	★	★	★	★	★	★	★	★	★	★	
NEW	LOGU0904160PNER-L	G	E	●	●	●	●	●	●	●	★	★	★	★	★	★	
	LOGU0904020PNFR-L	G	F							●	★	★	★	★	★	★	
	LOGU0904040PNFR-L	G	F							●	★	★	★	★	★	★	
	LOGU0904080PNFR-L	G	F							●	★	★	★	★	★	★	
	LOGU0904100PNFR-L	G	F							★	★	★	★	★	★	★	
	LOGU0904120PNFR-L	G	F							★	★	★	★	★	★	★	
	LOGU0904160PNFR-L	G	F							★	★	★	★	★	★	★	Outil représenté à droite.
VPX200 K086 VPX200 Série longue K114	LOGU0904020PNER-M	G	E	★	★	★	★	★	★	★	★	★	★	★	★	★	
	LOGU0904040PNER-M	G	E	●	●	●	●	●	●	●	★	★	★	★	★	★	
	LOGU0904080PNER-M	G	E	●	●	●	●	●	●	●	★	★	★	★	★	★	
	LOGU0904100PNER-M	G	E	★	★	★	★	★	★	★	★	★	★	★	★	★	
	LOGU0904120PNER-M	G	E	★	★	★	★	★	★	★	★	★	★	★	★	★	
	LOGU0904160PNER-M	G	E	●	●	●	●	●	●	●	★	★	★	★	★	★	
	LOGU0904020PNFR-M	G	F							●	★	★	★	★	★	★	
	LOGU0904040PNFR-M	G	F							●	★	★	★	★	★	★	
	LOGU0904080PNFR-M	G	F							●	★	★	★	★	★	★	
	LOGU0904100PNFR-M	G	F							★	★	★	★	★	★	★	
	LOGU0904120PNFR-M	G	F							★	★	★	★	★	★	★	
	LOGU0904160PNFR-M	G	F							★	★	★	★	★	★	★	



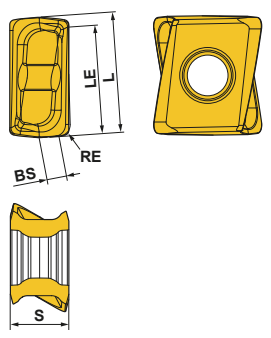
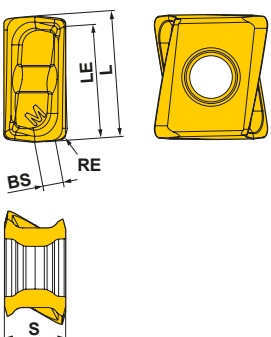







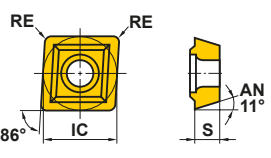

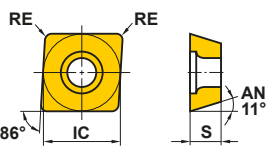
● ★ = NEW

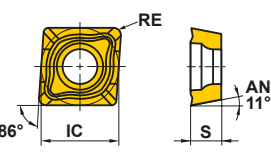
Matière	P	Acier	● ● ● ● ● ●						Conditions de coupe (Guide): ●: Coupe Stable ●: Coupe Générale ✦: Coupe Instable	Honing: E: Arrondie F: Vive	Forme	Référence	Classe	Honing	Revêtu						Carbure	Dimensions (mm)					Géométrie
	M	Acier Inoxydable	● ● ● ● ● ●												TF15	L	RE	LE	S	BS							
	K	Fonte	● ● ● ● ● ●																								
N	Non-ferreux	● ● ● ● ● ●																									
S	Alliage réfractaire, Alliage titane	● ● ● ● ● ●																									
H	Acier trempé	● ● ● ● ● ●																									
VPX300 K100 VPX300 Série longue K124	LOGU1207020PNER-L	G	E	★	★	★	★	★	★	★	★	★			12.4	0.2	11.3	7.0	3.0								
	LOGU1207040PNER-L	G	E	●	●	●	●	●	●	●	●	★			12.4	0.4	11.3	7.0	2.8								
	LOGU1207080PNER-L	G	E	●	●	●	●	●	●	●	●	★			12.4	0.8	11.3	7.0	2.6								
	LOGU1207100PNER-L	G	E	★	★	★	★	★	★	★	★	★			12.4	1.0	11.3	7.0	2.5								
	LOGU1207120PNER-L	G	E	●	●	●	●	●	●	●	●	★			12.4	1.2	11.3	7.0	2.4								
	LOGU1207160PNER-L	G	E	●	●	●	●	●	●	●	●	★			12.4	1.6	11.3	7.0	1.8								
	LOGU1207200PNER-L	G	E	●	●	●	●	●	●	●	●	★			12.4	2.0	11.3	7.0	1.4								
	LOGU1207240PNER-L	G	E	●	●	●	●	●	●	●	●	★			12.4	2.4	11.3	7.0	1.2								
	LOGU1207300PNER-L	G	E	★	★	★	★	★	★	★	★	★			12.4	3.0	11.3	7.0	0.6								
	LOGU1207320PNER-L	G	E	●	●	●	●	●	●	●	●	★			12.4	3.2	11.3	7.0	0.4								
	LOGU1207020PNFR-L	G	F									★			12.4	0.2	11.3	7.0	3.0								
	LOGU1207040PNFR-L	G	F									●			12.4	0.4	11.3	7.0	2.8								
	LOGU1207080PNFR-L	G	F									●			12.4	0.8	11.3	7.0	2.6								
	LOGU1207100PNFR-L	G	F									★			12.4	1.0	11.3	7.0	2.5								
	LOGU1207120PNFR-L	G	F									●			12.4	1.2	11.3	7.0	2.4								
	LOGU1207160PNFR-L	G	F									●			12.4	1.6	11.3	7.0	1.8								
	LOGU1207200PNFR-L	G	F									●			12.4	2.0	11.3	7.0	1.4								
	LOGU1207240PNFR-L	G	F									●			12.4	2.4	11.3	7.0	1.2								
	LOGU1207300PNFR-L	G	F									★			12.4	3.0	11.3	7.0	0.6								
	LOGU1207320PNFR-L	G	F									●			12.4	3.2	11.3	7.0	0.4								
VPX300 K100 VPX300 Série longue K124	LOGU1207020PNER-M	G	E	★	★	★	★	★	★	★	★	★			12.4	0.2	11.3	7.0	3.0								
	LOGU1207040PNER-M	G	E	●	●	●	●	●	●	●	●	★			12.4	0.4	11.3	7.0	2.8								
	LOGU1207080PNER-M	G	E	●	●	●	●	●	●	●	●	★			12.4	0.8	11.3	7.0	2.4								
	LOGU1207100PNER-M	G	E	★	★	★	★	★	★	★	★	★			12.4	1.0	11.3	7.0	2.3								
	LOGU1207120PNER-M	G	E	●	●	●	●	●	●	●	●	★			12.4	1.2	11.3	7.0	2.1								
	LOGU1207160PNER-M	G	E	●	●	●	●	●	●	●	●	★			12.4	1.6	11.3	7.0	1.7								
	LOGU1207200PNER-M	G	E	●	●	●	●	●	●	●	●	★			12.4	2.0	11.3	7.0	1.4								
	LOGU1207240PNER-M	G	E	●	●	●	●	●	●	●	●	★			12.4	2.4	11.3	7.0	1.0								
	LOGU1207300PNER-M	G	E	★	★	★	★	★	★	★	★	★			12.4	3.0	11.3	7.0	0.5								
	LOGU1207320PNER-M	G	E	●	●	●	●	●	●	●	●	★			12.4	3.2	11.3	7.0	0.3								
	LOGU1207020PNFR-M	G	F									★			12.4	0.2	11.3	7.0	3.0								
	LOGU1207040PNFR-M	G	F									●			12.4	0.4	11.3	7.0	2.8								
	LOGU1207080PNFR-M	G	F									●			12.4	0.8	11.3	7.0	2.4								
	LOGU1207100PNFR-M	G	F									★			12.4	1.0	11.3	7.0	2.3								
	LOGU1207120PNFR-M	G	F									●			12.4	1.2	11.3	7.0	2.1								
	LOGU1207160PNFR-M	G	F									●			12.4	1.6	11.3	7.0	1.7								
	LOGU1207200PNFR-M	G	F									●			12.4	2.0	11.3	7.0	1.4								
	LOGU1207240PNFR-M	G	F									●			12.4	2.4	11.3	7.0	1.0								
	LOGU1207300PNFR-M	G	F									★			12.4	3.0	11.3	7.0	0.5								
	LOGU1207320PNFR-M	G	F									●			12.4	3.2	11.3	7.0	0.3								

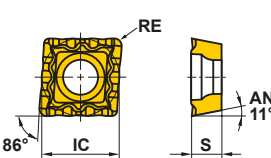

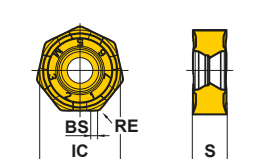

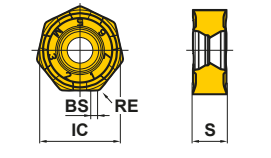

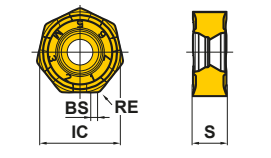



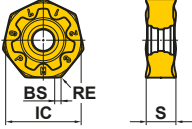

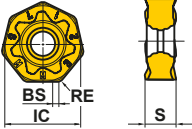
● ★ = NEW

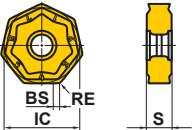
PLAQUETTES DE FRAISAGE

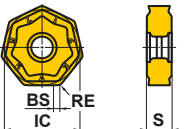

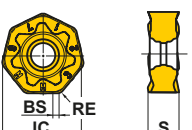

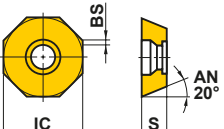
PLAQUETTES DE FRAISAGE

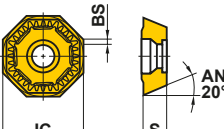
Forme	Référence	Classe	Honing	Revêtu								Carbure	Dimensions (mm)				Géométrie	
				MC5020	MP6120	MP6130	MP7130	MP7140	VP15TF	VP20RT	UP20M	UT120T	IC	S	BS	RE		
	MPMT070308	M	E															
	MPMT090308	M	E						★	★	●							
	MPMT120408	M	E							★	●							
	MPMW070308	M	E															
	MPMW090308	M	E								●							
	MPMW120408	M	E								●							
	MPMX120412-JM	M	E															
	MPMX120412-WH	M	E															
	NNMU130508ZER-L	M	E	●	●	●	●	●	★									
	NNMU130508ZEN-M	M	E	●	●	●	●	●	★									
	NNMU130532ZEN-M	M	E	●	●	●	●	●	★									
	NNMU130532ZEN-R	M	E	●	●	●	●	●	★									
	NNMU130532ZEN-R	M	E	●	●	●	●	●	★									
	NNMU130532ZEN-R	M	E	●	●	●	●	●	★									

● : Article stocké. ★ : Article standard Japon.
(10 plaquettes par boîte)

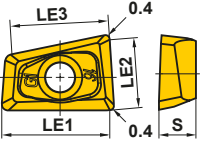
Forme	Référence	Classe	Honing	Revêtu								Cermet	Dimensions (mm)				Géométrie		
				MP6120	MP6130	MP9120	MP9130	F7010	F7030	MC5020	MP7030	VP15TF	VP20RT	NX4545	IC	S		BS	RE
AHX640S 	NNMU200708ZEN-M	M	E	●	●										20	8	1	0.8	
	NNMU200708ZEN-MP	M	E							●					20	8	1	0.8	
AHX640S 	NNMU200712ZER-MM	M	E								●				20	8	1	1.2	
AHX640W AHX640S 	NNMU200608ZEN-MK	M	E							●	★	★			20	6.55	1	0.8	
AHX640W AHX640S 	NNMU200608ZEN-HK	M	E							●	★	★			20	6.55	1	0.8	
AHX640S 	NNMU200712ZER-L	M	E	●	●										20	8	1	1.2	
OCTACUT 	OEMX12T3ETR1	M	T					●				★		12.7	3.97	1	—		
	OEMX12T3ESR1	M	S					●						12.7	3.97	1	—		
	OEMX1705ETR1	M	T					●		★	●			17	5	1.4	—		
	OEMX1705ESR1	M	S					●						17	5	1.4	—		
OCTACUT 	OEMX12T3EER1-JS	M	E					●						12.7	3.97	1	—		
	OEMX1705EER1-JS	M	E					●						17	5	1.4	—		
	OEMX1705ETR1-JS	M	T							★				17	5	1.4	—		

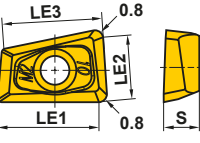

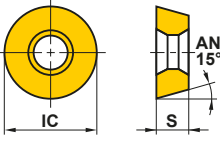
PLAQUETTES DE FRAISAGE

Matière	P	Acier	●	●	●	●	●	●	●	●	●	●	●	Conditions de coupe (Guide) : ● : Coupe Stable ● : Coupe Générale ✪ : Coupe Instable Honing : E : Arrondie F : Vive S : Chanfrein + Rayon							
	M	Acier Inoxydable	●	●	●	●	●	●	●	●	●	●	●								
Forme	K	Fonte	●	●	●	●	●	●	●	●	●	●	●	Revêtu F7030 MP6120 MP6130 MP7130 MP7140 MP9120 VP15TF VP30RT VP10H VP05HT MP8010 HTi10 Carbure Dimensions (mm) LE1 LE2 LE3 IC S Géométrie							
	N	Non-ferreux	●	●	●	●	●	●	●	●	●	●	●								
	S	Alliage réfractaire, Alliage titane	●	●	●	●	●	●	●	●	●	●	●								
	H	Matières traitées / trempées	●	●	●	●	●	●	●	●	●	●	●								
AQX ↻K172 	QOGT0830R-G1	G	E *1	★				★	●					●	7.7	4.9	7.3	-	3		
	QOGT1035R-G1	G	E *1	★				★	●					●	9.9	6.4	9.3	-	3.5		
	QOGT1342R-G1	G	E *1	★				★	●					●	12.4	8.1	11.6	-	4.2		
	QOGT1651R-G1	G	E *1	★				★	●					●	15.8	10.4	14.6	-	5.1		
	QOGT1856R-G1	G	E *1	★				★	●					●	17.3	11.4	16	-	5.6		
	QOGT2062R-G1	G	E *1	★				★	●					●	19.8	13.1	18.1	-	6.2		
	QOGT2576R-G1	G	E *1	★				★	●					●	25.2	16.6	23.1	-	7.6		
AQX ↻K172 	QOMT0830R-M2	M	E	●	●	●	●	●	●	●	●	●			7.3	4.4	7.3	-	3		
	QOMT1035R-M2	M	E	●	●	●	●	●	●	●	●	●			9.5	5.9	9.3	-	3.5		
	QOMT1342R-M2	M	E	●	●	●	●	●	●	●	●	●			12	7.6	11.6	-	4.2		
	QOMT1651R-M2	M	E	●	●	●	●	●	●	●	●	●			15.4	9.9	14.6	-	5.1		
	QOMT1856R-M2	M	E	●	●	●	●	●	●	●	●	●			16.9	10.9	16	-	5.6		
	QOMT2062R-M2	M	E	●	●	●	●	●	●	●	●	●			19.4	12.6	18.1	-	6.2		
	QOMT2576R-M2	M	E	●	●	●	●	●	●	●	●	●			24.8	16.1	23.1	-	7.6		
RRD 	RDHX0501M0E	H	E	●				●	●	●					-	-	-	5	1.5		
	RDHX0501M0S	H	S	●				●	●							-	-	-	5		1.5
	RDHX07T1M0E	H	E	●				●	●	●						-	-	-	7		1.98
	RDHX07T1M0S	H	S	●				●	●	●						-	-	-	7		1.98
	RDHX0702M0E	H	E	●				●	●	●						-	-	-	7		2.38
	RDHX0702M0S	H	S	●				●	●							-	-	-	7		2.38
	RDHX1003M0E	H	E	●				●	●	●						-	-	-	10		3.18
	RDHX1003M0S	H	S	●				●	●	●						-	-	-	10		3.18
	RDHX12T3M0E	H	E	●				●	●	●						-	-	-	12		3.97
	RDHX12T3M0S	H	S	●				●	●							-	-	-	12		3.97
	RDHX1604M0E	H	E	●				●	●	●						-	-	-	16		4.76
	RDHX1604M0S	H	S	●				●	●							-	-	-	16		4.76

*1 La nuance HTi10 a une préparation d'arête "F".



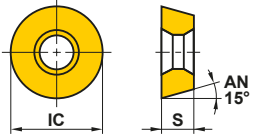

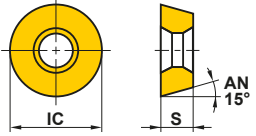
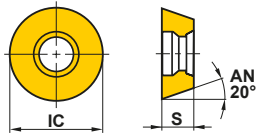
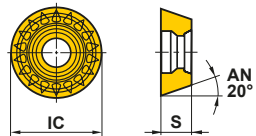
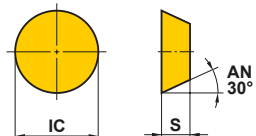

● : Article stocké. ★ : Article standard Japon.

□ : Article non stocké - Fabrication sur commande uniquement. (10 plaquettes par boîte)

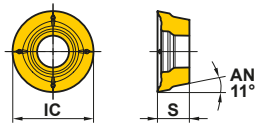
Forme	Référence	Classe	Honing	Revêtu						Cermet	Carbure	Dimensions (mm)		Géométrie
				F7030	VP15TF	VP20M	VP10H	VP05HT	UP20M	NX4545	UTi20T	HTi10	IC	
	RRD RDMX07T1M0E	M	E									7	1.98	
	RDMX07T1M0T	M	T	□	●	●						7	1.98	
	RDMX0702M0E	M	E				□					7	2.38	
	RDMX0702M0T	M	T	●	●	●						7	2.38	
	RDMX1003M0E	M	E				●					10	3.18	
	RDMX1003M0S	M	S		●	●						10	3.18	
	RDMX1003M0T	M	T	●	●	●		●	□			10	3.18	
	RDMX12T3M0E	M	E				●					12	3.97	
	RDMX12T3M0S	M	S		●	●						12	3.97	
	RDMX12T3M0T	M	T	●	●	●		□	□			12	3.97	
	RDMX1604M0E	M	E				●					16	4.76	
	RDMX1604M0S	M	S		●	●						16	4.76	
	RDMX1604M0T	M	T	●	●	●		□	□			16	4.76	
	RRD RDZX0501M0E	Z	E		●							5	1.50	
	RDZX07T1M0E	Z	E		●							7	1.98	
	RDZX0702M0E	Z	E		●							7	2.38	
	RDZX1003M0E	Z	E		●							10	3.18	
	RDZX1003M0S	Z	S		●	●						10	3.18	
	RDZX12T3M0E	Z	E		●							12	3.97	
	RDZX12T3M0S	Z	S		●	●						12	3.97	
	RDZX1604M0E	Z	E		●							16	4.76	
	RDZX1604M0S	Z	S		●	●						16	4.76	
OCTACUT	REMX1705SN	M	S	★								17.25	5.2	
OCTACUT	REMX12T3EN-JS	M	E	★								12.95	4.17	
	REMX1705EN-JS	M	E	★								17.25	5.2	
SG20	RGEN2004M0EN	E	E	★								20	4.76	
	RGEN2004M0SN	E	S	●			●		●	●		20	4.76	

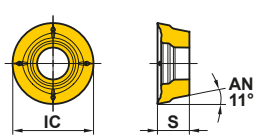
PLAQUETTES DE FRAISAGE

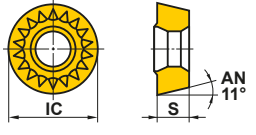

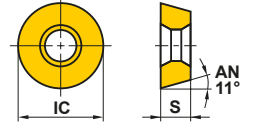





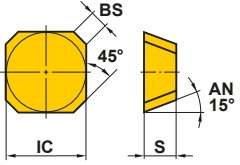
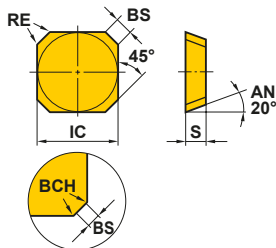

PLAQUETTES DE FRAISAGE

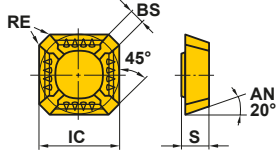
Matière	P Acier		M Acier Inoxydable		K Fonte		N Non-ferreux		S Alliage réfractaire, Alliage titane		H Matières traitées / trempées		Conditions de coupe (Guide): ●: Coupe Stable ●: Coupe Générale ✦: Coupe Instable Honing: E: Arrondie T: Chanfrein					
	●	●	●	●	●	●	●	●	●	●	●							
Forme	Référence	Classe	Honing	Revêtu							Cermet	Carbure	Dimensions (mm)			Géométrie		
				F7010	F7030	MC7020	MP7130	MP9130	NEW MP9140	VP15TF	AP20M	NX2525	NX4545	UT120T	IC		S	BS
	ARP5/6 K238	RPHT1040M0E4-L	H	E			●	●	●						10	3.97	—	
		RPHT1248M0E4-L	H	E			●	●	●						12	4.76	—	
		RPHT1040M0E4-M	H	E			●	●	●						10	3.97	—	
		RPHT1248M0E4-M	H	E			●	●	●						12	4.76	—	
		RPHT1040M0E4-R	H	E			●	●	●						10	3.97	—	
		RPHT1248M0E4-R	H	E			●	●	●						12	4.76	—	
	ARP5/6 K238	RPMT1040M0E4-L	M	E			●	●	●						10	3.97	—	
		NEW RPMT1040M0E8-L1	M	E			●	●	●	●					10	3.97	—	
		NEW RPMT1040M0E4-L2	M	E						●					10	3.97	—	
		RPMT1248M0E4-L	M	E			●	●	●						12	4.76	—	
		NEW RPMT1248M0E8-L1	M	E			●	●	●	●					12	4.76	—	
		NEW RPMT1248M0E4-L2	M	E						●					12	4.76	—	
		RPMT1040M0E4-M	M	E			●	●	●						10	3.97	—	
		NEW RPMT1040M0E8-M1	M	E			●	●	●	●					10	3.97	—	
		NEW RPMT1040M0E4-M2	M	E						●					10	3.97	—	
		RPMT1248M0E4-M	M	E			●	●	●						12	4.76	—	
		NEW RPMT1248M0E8-M1	M	E			●	●	●	●					12	4.76	—	
		NEW RPMT1248M0E4-M2	M	E						●					12	4.76	—	
		RPMT1040M0E4-R	M	E			●	●	●						10	3.97	—	
		NEW RPMT1040M0E8-R1	M	E			●	●	●						10	3.97	—	
	RPMT1248M0E4-R	M	E			●	●	●						12	4.76	—		
	NEW RPMT1248M0E8-R1	M	E			●	●	●						12	4.76	—		
	BRP K190	RPMT08T2M0E-JS	M	E			●				●		●	8	2.78	—		
		RPMT10T3M0E-JS	M	E			●				●		●	10	3.97	—		
		RPMT1204M0E-JS	M	E	●	●					●	●		●	12	4.76		—
		RPMT1606M0E-JS	M	E	●						●	●		●	16	6.35		—
	BRP K190	RPMW08T2M0E	M	E									●	8	2.78	—		
		RPMW08T2M0T	M	T						●				8	2.78	—		
		RPMW10T3M0E	M	E	★						★	□		10	3.97	—		
		RPMW10T3M0T	M	T						●				10	3.97	—		
		RPMW1204M0E	M	E	●						●	□	●	●	12	4.76		—
		RPMW1204M0T	M	T						●		●			12	4.76		—
		RPMW1606M0E	M	E	●						●	□	●	●	16	6.35		—
		RPMW1606M0T	M	T						●					16	6.35		—

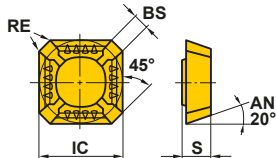
● = NEW

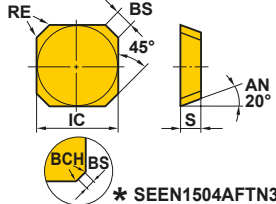
● : Article stocké. ★ : Article standard Japon.

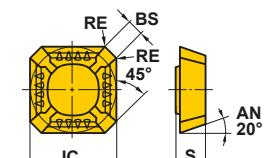
□ : Article non stocké - Fabrication sur commande uniquement. (10 plaquettes par boîte)

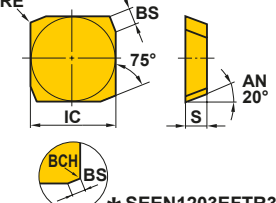
Matière	P	Acier	●	●	●	●	●	●	Conditions de coupe (Guide): ●: Coupe Stable ●: Coupe Générale ✖: Coupe Instable Honing: E: Arrondie F: Vive S: Chanfrein + Rayon T: Chanfrein Z: Renfort					
	M	Acier Inoxydable	●	●	●	●	●	●						
Matière	K	Fonte	●	●	●	●	●	●	Conditions de coupe (Guide): ●: Coupe Stable ●: Coupe Générale ✖: Coupe Instable Honing: E: Arrondie F: Vive S: Chanfrein + Rayon T: Chanfrein Z: Renfort					
	N	Non-ferreux	●	●	●	●	●	●						
	S	Alliage réfractaire, Alliage titane	●	●	●	●	●	●						
Forme	Référence	Classe	Honing	Revêtu		Cermet	Carbure	Dimensions (mm)					Géométrie	
				F7010	F7030	MC5020	VP15TF	UP20M	NX2525	NX4545	UTi20T	HTi10		IC
Angle d'attaque 45° 	SDEN1203AEN	E	T				●		12.7	3.18	1.2	—	—	
	LSE445 SE445	E	E				●		12.7	3.18	1.4	—	1.0	 * SEEN1203AFTN3
	SEEN1203AFEN1	E	E				●		12.7	3.18	1.4	—	1.0	
	SEEN1203AFTN1	E	T			●			12.7	3.18	1.4	—	1.0	
	* SEEN1203AFTN3	E	T				●		12.7	3.18	1.4	0.77	—	
LSE445 SE445 	SEER1203AFEN-JS	E	E	●	●	●	●		12.7	3.18	1.4	—	1.0	
Angle d'attaque 45° 	SEER1204AFEN-JS	E	E	●					12.7	4.76	1.4	—	1.0	
SE545 	SEEN1504AFEN1	E	E			★			15.875	4.76	1.4	—	1.0	 * SEEN1504AFTN3
	SEEN1504AFTN1	E	T	□		●	★	●	15.875	4.76	1.4	—	1.0	
	* SEEN1504AFTN3	E	T	●					15.875	4.76	1.4	0.77	—	
	SEEN1504AFSN1	E	S	●	●				15.875	4.76	1.4	—	1.0	
SE545 	SEER1504AFEN-JS	E	E	●	●	★			15.875	4.76	1.4	—	1.0	
SE415 	SEEN1203EFFR1	E	F					●	12.7	3.18	1.4	—	1.0	 * SEEN1203EFTR3 Plaquette représentée à droite.
	SEEN1203EFER1	E	E			★			12.7	3.18	1.4	—	1.0	
	SEEN1203EFTR1	E	T				★	●	12.7	3.18	1.4	—	1.0	
	* SEEN1203EFTR3	E	T					●	12.7	3.18	1.4	—	—	
	SEEN1203EFSTR1	E	S	●	●				12.7	3.18	1.4	—	1.0	

PLAQUETTES DE FRAISAGE

PLAQUETTES DE FRAISAGE

PLAQUETTES DE FRAISAGE

Forme	Référence	Classe	Honing	Revêtu											Cermet	Carbure	Dimensions (mm)				Géométrie							
				F7030	MC5020	MP6120	MP6130	MP7130	MP7140	MP9120	MP9130	VP15TF	VP30RT	UP20M	NX2525	NX4545	UTi20T	HTi10	IC	S		BS	RE					
Matière P Acier M Acier Inoxydable K Fonte N Non-ferreux S Alliage réfractaire, Alliage titane H Matières traitées / trempées		Conditions de coupe (Guide): ● : Coupe Stable ●● : Coupe Générale ✕ : Coupe Instable Honing: E : Arrondie F : Vive S : Chanfrein + Rayon T : Chanfrein																										
	SEER1203EFER-JS	E	E	●	★													12.7	3.18	1.4	1.0	 Plaquette représentée à droite.						
	SE515	SECN1504EFTR1	C	T										★					15.875	4.76	1.4		1.0					
	SEEN1504EFER1	E	E															15.875	4.76	1.4	1.0	 Plaquette représentée à droite.						
	SEEN1504EFTR1	E	T											●				15.875	4.76	1.4	1.0							
	SEEN1504EFRS1	E	S	●														15.875	4.76	1.4	1.0							
Angle d'attaque 45° 	SEEW1204AFTN	E	T													●●●		12.7	4.76	2.6	1.0	 Plaquette représentée à droite.						
Angle d'attaque 45° 	SEM1204AZTN	M	T													●●●		12.7	4.76	2.0	0.2							
	ASX445 K026	G	F															●	13.4	3.97	2.2	—	 Plaquette représentée à droite.					
	ASX445 K026	SEET13T3AGEN-JL	E	E	●	●	●	●	●	●	●	●	●	●			●		13.4	3.97	1.9	1.5						
	ASX445 K026	M	S	●															13.4	3.97	1.9	1.5	 Plaquette représentée à droite.					

● : Article stocké. ★ : Article standard Japon.











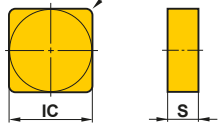

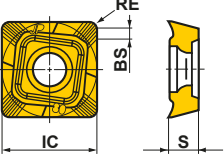
(10 plaquettes par boîte)

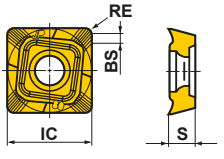
Matière	P	Acier	●	●	●	●	●	●	●	●	●	●	●	●	●	●	●	●	●	●	Conditions de coupe (Guide) : ● : Coupe Stable ● : Coupe Générale ✱ : Coupe Instable Honing : E : Arrondie F : Vive S : Chanfrein + Rayon T : Chanfrein				
	M	Acier Inoxydable	●	●	●	●	●	●	●	●	●	●	●	●	●	●	●	●	●	●					
Matière	K	Fonte	●	●	●	●	●	●	●	●	●	●	●	●	●	●	●	●	●	●					
	N	Non-ferreux	●	●	●	●	●	●	●	●	●	●	●	●	●	●	●	●	●	●					
	S	Alliage réfractaire, Alliage titane	●	●	●	●	●	●	●	●	●	●	●	●	●	●	●	●	●	●					
Matière	H	Matières traitées / trempées	●	●	●	●	●	●	●	●	●	●	●	●	●	●	●	●	●	●					
	Forme		Référence	Classe	Honing	Revêtu										Cermet	Carbure	Dimensions (mm)		Géométrie					
					F7030	MC5020	MP6120	MP6130	MP7130	MP7140	MP9120	MP9130	VP15TF	VP20RT	VP30RT	UP20M	MX3030	NX4545	VP45N		UTi20T	HTi10	TF15	IC	S
ASX445 K026	SEMT13T3AGSN-JH	M	S	●	●	●	●	●	●	●	●	●	●	●	●	●							13.4	3.97	
	SEMT13T3AGSN-JM	M	S	●	●	●	●	●	●	●	●	●	●	●	●	●	●	●	●				13.4	3.97	
BF407	SFAN1203ZFFR2	A	F																	●			12.7	3.175	
	SFAN1203ZFFL2	A	F																	★			12.7	3.175	
	SFCN1203ZFFR2	C	F																	●			12.7	3.175	
BN425 DN	SNC43B2S	C	T																★				12.7	4.8	
	SNEN1204EN	E	E																	●			12.7	4.76	
	SNEN1504EN	E	E																	★			15.88	4.76	
WSX445 K016	SNGU140812ANFR-L	G	F																	●			14	8.4	
	SNGU140812ANFL-L	G	F																	★			14	8.4	
	SNGU140812ANER-L	G	E	●	●	●	●	●	●	●	●	●	★	★			●						14	8.4	
	SNGU140812ANEL-L	G	E	★	★	★												★					14	8.4	
	SNGU140812ANER-M	G	E	●	●	●	●	●	●	●	●	●	★	★			●						14	8.4	
	SNGU140812ANEL-M	G	E	★	★	★												★					14	8.4	
	SNMU140812ANER-M	M	E	●	●	●	●	●	●	●	●	●	★	★			●						14	8.4	
	SNMU140812ANEL-M	M	E	★	★	★												★					14	8.4	
	SNMU140812ANER-R	M	E	●	●	●								★	★								14	8.4	
	SNMU140812ANEL-R	M	E	★	★	★																	14	8.4	
SNMU140812ANER-H	M	E	●	●	●								★	★								14	8.4		
BN425 DN	SNMF43B2G	M	E	★																			12.7	4.8	

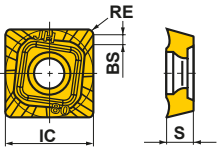
PLAQUETTES DE FRAISAGE

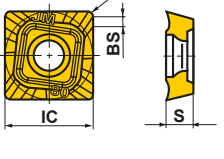

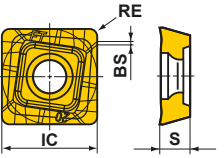

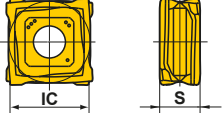

PLAQUETTES DE FRAISAGE

PLAQUETTES DE FRAISAGE

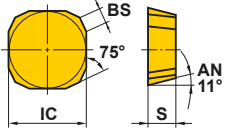
Matière	P	Acier	●	●	●	●	●	●	●	●	●	●	●	●	Conditions de coupe (Guide) : ● : Coupe Stable ● : Coupe Générale ✖ : Coupe Instable Honing : E : Arrondie F : Vive							
	M	Acier Inoxydable	●	●	●	●	●	●	●	●	●	●	●	●								
	K	Fonte	●	●	●	●	●	●	●	●	●	●	●	●								
N	Non-ferreux																					
S	Alliage réfractaire, Alliage titane																					
H	Matières traitées / trempées																					
Forme	Référence	Classe	Honing	Revêtu										Cermet	Carbure	Dimensions (mm)				Géométrie		
				F7030	MC5020	MP6120	MP6130	MP7130	MP7140	MP9120	MP9130	VP15TF	VP30RT			NX2525	NX4545	UTi20T	HTi10		IC	S
	SNMN120408	M	E		★										★	●	★	12.7	4.76	—	0.8	
	SNMN120412	M	E		●										★	●		12.7	4.76	—	1.2	
	ASX400 K068 SOET12T308PEER-JL	E	E	●		●	●	●	●	●	●	●	●	●	●			12.7	3.97	1.4	0.8	
	ASX400 K068 SOGT12T308PEFR-JP	G	F													●		12.7	3.97	1.4	0.8	
	ASX400 K068 SOMT12T308PEER-JH	M	E	●	●	●	●	●	●	●	●	●	●	●	●			12.7	3.97	1.4	0.8	
	ASX400 K068 SOMT12T308PEER-JM	M	E	●	●	●	●	●	●	●	●	●	●	●	●	●		12.7	3.97	1.4	0.8	 Plaque représentée à droite.
	ASX400 Fraise 3 Tailles SOMT12T308PEEL-JM	M	E													●		12.7	3.97	1.4	0.8	
	ASX400 K068 SOMT12T320PEER-FT	M	E	●	●					★	★	●						12.7	3.97	0.5	2.0	
	VOX400 K065 SONX1206PER	N	E	●												●		12.7	6.3	—	—	 Plaque représentée à droite.
	SONX1206PEL	N	E													★		12.7	6.3	—	—	

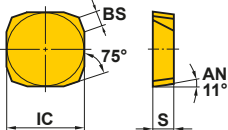
● : Article stocké. ★ : Article standard Japon.

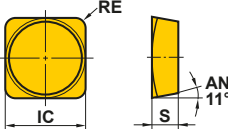
□ : Article non stocké - Fabrication sur commande uniquement. (10 plaquettes par boîte)

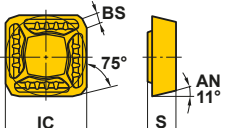
Matière	P	Acier									Conditions de coupe (Guide): ●: Coupe Stable ●: Coupe Générale ✘: Coupe Instable				
	M	Acier Inoxydable													
Matière	K	Fonte									Honing: E: Arrondie F: Vive T: Chanfrein				
	N	Non-ferreux													
	S	Alliage réfractaire, Alliage titane													
	H	Matières traitées / trempées													
Forme	Référence	Classe	Honing	Revêtu			Cermet		Carbure		Dimensions (mm)				Géométrie
				F7030	MC5020	UP20M	NX2525	NX4545	UTi20T	HTi10	IC	S	BS	RE	
Angle d'attaque 15° 	SPEN1203EDR	E	T	●				● ●			12.7	3.18	1.4	—	 Plaquette représentée à droite.
	SPEN1203EDL	E	T *1					□ ★ □			12.7	3.18	1.4	—	
	SPEN1504EDR	E	T *1		●			□ ● □			15.875	4.76	1.4	—	
	SPEN1504EDL	E	T						●		15.875	4.76	1.4	—	
FBP415 	SPEN1203EEER1	E	E	●					★		12.7	3.175	1.4	—	 Plaquette représentée à droite.
	SPEN1203EEEL1	E	E	★					★		12.7	3.175	1.4	—	
	SPNN1203EEER1	N	E	★					★		12.7	3.18	1.3	—	
	SPNN1203EEEL1	N	E						★		12.7	3.18	1.3	—	
FP490 	SPEN424A	E	F						★		12.7	3.18	—	1.6	
FBP415 	SPER1203EEER-JS	E	E	●							12.7	3.18	1.4	—	

*1 La nuance HTi10 a une préparation d'arête "F".







PLAQUETTES DE FRAISAGE

PLAQUETTES DE FRAISAGE

Matière	P Acier		M Acier Inoxydable		K Fonte		N Non-ferreux		S Alliage réfractaire, Alliage titane		H Matières traitées / trempées		Revêtu		Cermet	Carbure	Dimensions (mm)				Géométrie	
	●	●	●	●	●	●	●	●	●	●	●	●	●	●	●	●	IC	S	BS	RE		
<p>Conditions de coupe (Guide): ●: Coupe Stable ●: Coupe Générale ✖: Coupe Instable</p> <p>Honing: E: Arrondie F: Vive T: Chanfrein</p>																						
11° Positive	SPGN120304	G	E *1												★	★ ●	12.7	3.18	—	0.4		
	SPGN120308	G	E *1												★	★ ●	12.7	3.18	—	0.8		
	SPGN120312	G	F													★		12.7	3.18	—		1.2
	SPGN150404	G	E													★		15.875	4.76	—		0.4
	SPGN150408	G	E *1													★		15.875	4.76	—		0.8
	SPMN120304	M	E *1													★	● ●	12.7	3.18	—		0.4
	SPMN120304T	M	T													●		12.7	3.18	—		0.4
	SPMN120308	M	E *1		★											★ ★	● ●	12.7	3.18	—		0.8
	SPMN120312	M	E *1		★											★	● ●	12.7	3.18	—		1.2
	SPMN120408	M	E *1		★											★	● ★	12.7	4.76	—		0.8
	SPMN120412	M	E		★											★		12.7	4.76	—		1.2
	SPMN150408	M	E													●		15.875	4.76	—		0.8
	SPMN150412	M	E													●		15.875	4.76	—		1.2
	ASPX K208	SPGX1204100PPER-JM	G	E												●		12.7	4.8	—		1.0
BSP	SPMB1204APT	M	T												●	●	12.7	4.76	1.4	—		
TBE1	SPMT120408-A	M	E												●	●	12.7	4.76	—	0.8		
CESP CFSP CGSP K230	SPMW090304	M	E *2												★ ● ● ● ● ●	9.525	3.18	—	0.4			
	SPMW090308	M	E *2												★ ● ★ ★ ● ●	9.525	3.18	—	0.8			
	SPMW120304	M	E *2												★ ● ● ● ● ●	12.7	3.18	—	0.4			
	SPMW120308	M	E *2												★ ● ● ● ● ●	12.7	3.18	—	0.8			

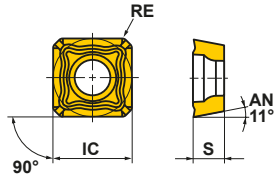

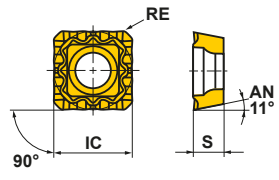

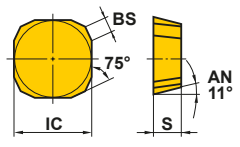



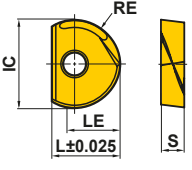

*1 La nuance HTi10 a une préparation d'arête "F".
 *2 La nuance HTi10 a une préparation d'arête "T".

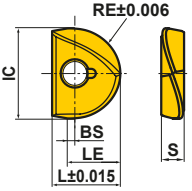
● = NEW

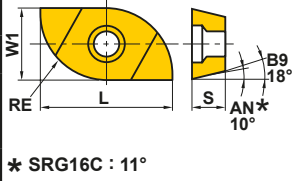
Matière	P	Acier	●	●		●	Conditions de coupe (Guide) : ● : Coupe Stable ● : Coupe Générale ✚ : Coupe Instable Honing : E : Arrondie				
	M	Acier Inoxydable	●	●		●					
K	Fonte	✚	✚		✚						
N	Non-ferreux										
S	Alliage réfractaire, Alliage titane	●	✚								
H	Matières traitées / trempées	●									
Forme	Référence	Classe	Honing	Revêtu	Carbure	Dimensions (mm)				Géométrie	
				VP15TF	VP20RT	UTi20T	IC	S	BS		RE
SPX  	SPMX120408-JM	M	E	●	●		12.7	4.80	—	0.8	
SPX  	SPMX120408-WH	M	E	●	●		12.7	4.76	—	0.8	
Angle d'attaque 15° 	SPNN1203EDR	N	E			●	12.7	3.18	1.4	—	 <p>Plaquette représentée à droite.</p>

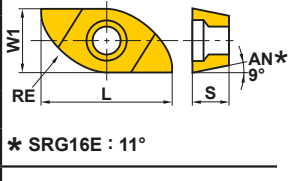
PLAQUETTES DE FRAISAGE

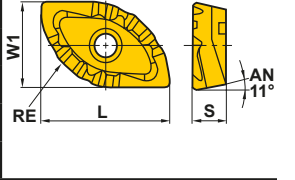
PLAQUETTES DE FRAISAGE

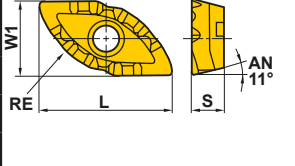
Forme	Référence	Classe	Honing	Revêtu							Dimensions (mm)						Géométrie	
				EP6120	MP6120	MP9120	VP15TF	VP20RT	VP30RT	MP8010	RE	L	LE	W1	IC	S		BS
				P	M	K	N	S	H	●	●	●	●	●	●	●		●
	* SRBT10	-	F	●	●	●	●	●	●	5	8.5	5	-	10	2.6	-		
	* SRBT12	-	F	●	●	●	●	●	●	6	10	6	-	12	3	-		
	* SRBT16	-	F	●	●	●	●	●	●	8	12	8	-	16	4	-		
	* SRBT20	-	F	●	●	●	●	●	●	10	15	10	-	20	5	-		
	* SRBT25	-	F	●	●	●	●	●	●	12.5	18.5	12.5	-	25	6	-		
	* SRBT30	-	F	●	●	●	●	●	●	15	22.5	15	-	30	7	-		
	* SRBT32	-	F	●	●	●	●	●	●	16	23.5	16	-	32	7	-		
	* SRFT10	-	F	●	●	●	●	●	5	8.5	5.5	-	10	2.6	0.5			
	* SRFT12	-	F	●	●	●	●	●	6	10	6.5	-	12	3	0.5			
	* SRFT16	-	F	●	●	●	●	●	8	12	9	-	16	4	1			
	* SRFT20	-	F	●	●	●	●	●	10	15	11	-	20	5	1			
	* SRFT25	-	F	●	●	●	●	●	12.5	18.5	13.5	-	25	6	1			
	* SRFT30	-	F	●	●	●	●	●	15	22.5	16	-	30	7	1			
	* SRFT32	-	F	●	●	●	●	●	16	23.5	17	-	32	7	1			
	SRG16C	G	E	●	★	●			8	16	-	8.2	-	3.5	-			
	SRG20C	G	E	●	★	●			10	19	-	10.2	-	4.6	-			
	SRG25C	G	E	●	★	●			12.5	24	-	12.8	-	5.5	-			
	SRG30C	G	E	●	★	●			15	28	-	15.3	-	7	-			
	SRG32C	G	E	●	★	●			16	28	-	16.3	-	7	-			
* SRG16C : 11°																		
	SRG16E	G	E	●	★	●			8	13.5	-	6.7	-	3.5	-			
	SRG20E	G	E	●	★	●			10	15.5	-	8.5	-	4.6	-			
	SRG25E	G	E	●	★	●			12.5	20.5	-	10.2	-	5.5	-			
	SRG30E	G	E	●	★	●			15	25.2	-	12.2	-	7	-			
	SRG32E	G	E	●	★	●			16	26.1	-	13.1	-	7	-			
* SRG16E : 11°																		
	* SRG40C	G	E		●	●	●		20	36	-	20.5	-	8	-			
	* SRG50C	G	E		●	●	●		25	40	-	26	-	8.5	-			
	* SRG40E	G	E		●	●	●		20	32	-	16.6	-	8	-			
	* SRG50E	G	E		●	●	●		25	35.8	-	20	-	8.5	-			

*Conditionnées par 2.







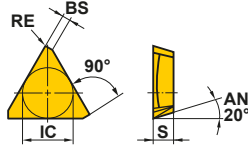

● : Article stocké. ★ : Article standard Japon.
(10 plaquettes par boîte)

Matière	P	Acier		Conditions de coupe (Guide):												
	M	Acier Inoxydable		●: Coupe Stable ●: Coupe Générale ✖: Coupe Instable												
K	Fonte	Honing:														
N	Non-ferreux	E: Arrondie F: Vive														
S	Alliage réfractaire, Alliage titane															
H	Matières traitées / trempées															
Forme	Référence	Classe	Honing	Revêtu				Dimensions (mm)						Géométrie		
				MP6120	MP9120	VP15TF	MP8010	RE	L	LE	W1	S	BS		AN	
SRM2 K220 	SRM16C-M	M	E	● ★ ●	●	●			8	16	—	8.2	3.5	—	11°	
	SRM20C-M	M	E	● ★ ●					10	19	—	10.2	4.6	—	10°	
	SRM25C-M	M	E	● ★ ●					12.5	24	—	12.8	5.5	—	10°	
	SRM30C-M	M	E	● ★ ●					15	28	—	15.3	7	—	10°	
	SRM32C-M	M	E	● ★ ●					16	28	—	16.3	7	—	10°	
SRM2 K220 	SRM16E-M	M	E	● ★ ●					8	13.5	—	6.7	3.5	—	11°	
	SRM20E-M	M	E	● ★ ●					10	15.5	—	8.5	4.6	—	9°	
	SRM25E-M	M	E	● ★ ●					12.5	20.5	—	10.2	5.5	—	9°	
	SRM30E-M	M	E	● ★ ●					15	25.2	—	12.2	7	—	9°	
	SRM32E-M	M	E	● ★ ●					16	26.1	—	13.1	7	—	9°	
SUF K216 	* SUFT10R05	—	F	● ●	● ●				0.5	8.5	1.5	10	2.6	1	—	
	* SUFT10R10	—	F	● ●	● ●				1	8.5	2	10	2.6	1	—	
	* SUFT10R20	—	F	★ ●	● ●				2	8.5	3	10	2.6	1	—	
	* SUFT12R05	—	F	● ●	● ●				0.5	10	1.7	12	3	1.2	—	
	* SUFT12R10	—	F	● ●	● ●				1	10	2.2	12	3	1.2	—	
	* SUFT12R20	—	F	● ●	● ●				2	10	3.2	12	3	1.2	—	
	* SUFT12R30	—	F	● ★	● ●				3	10	4.2	12	3	1.2	—	
	* SUFT16R05	—	F	● ●	● ●				0.5	12	2.1	16	4	1.6	—	
	* SUFT16R10	—	F	● ●	● ●				1	12	2.6	16	4	1.6	—	
	* SUFT16R15	—	F	● ★	● ●				1.5	12	3.1	16	4	1.6	—	
	* SUFT16R20	—	F	● ●	● ●				2	12	3.6	16	4	1.6	—	
	* SUFT16R30	—	F	● ★	● ●				3	12	4.6	16	4	1.6	—	
	* SUFT20R05	—	F	● ●	● ●				0.5	15	2.5	20	5	2	—	
	* SUFT20R10	—	F	● ●	● ●				1	15	3	20	5	2	—	
	* SUFT20R15	—	F	● ★	● ●				1.5	15	3.5	20	5	2	—	
	* SUFT20R20	—	F	● ●	● ●				2	15	4	20	5	2	—	
	* SUFT20R30	—	F	● ●	● ●				3	15	5	20	5	2	—	
	* SUFT25R05	—	F	● ★	● ●				0.5	18.5	3	25	6	2.5	—	
	* SUFT25R10	—	F	★ ●	● ●				1	18.5	3.5	25	6	2.5	—	
	* SUFT25R20	—	F	● ★	● ●				2	18.5	4.5	25	6	2.5	—	
* SUFT25R30	—	F	● ★	● ●				3	18.5	5.5	25	6	2.5	—		
* SUFT30R05	—	F	★ ★	● ●				0.5	22.5	3.5	30	7	3	—		
* SUFT30R10	—	F	★ ★	● ●				1	22.5	4	30	7	3	—		
* SUFT30R20	—	F	★ ★	● ●				2	22.5	5	30	7	3	—		
* SUFT30R30	—	F	★ ★	● ●				3	22.5	6	30	7	3	—		
* SUFT32R05	—	F	★ ★	● ●				0.5	23.5	3.7	32	7	3.2	—		
* SUFT32R10	—	F	★ ★	● ●				1	23.5	4.2	32	7	3.2	—		
* SUFT32R20	—	F	★ ★	● ●				2	23.5	5.2	32	7	3.2	—		

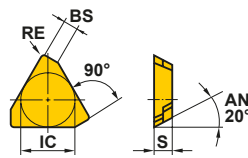
*Conditionnées par 2.

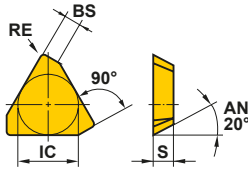

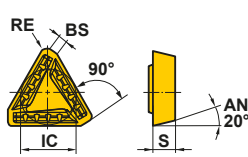

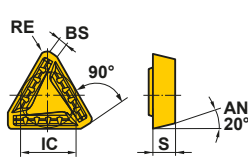

PLAQUETTES DE FRAISAGE

PLAQUETTES DE FRAISAGE

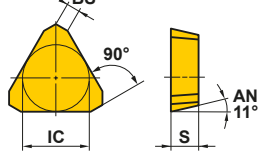
Matière	P	Acier	●	●	●	●	●	●	Conditions de coupe (Guide) : ● : Coupe Stable ● : Coupe Générale ✖ : Coupe Instable Honing : E : Arrondie F : Vive S : Chanfrein + Rayon T : Chanfrein Z : Renfort							
	M	Acier Inoxydable	●	●	●	●	●	●								
	K	Fonte	●	●	●	●	●	●								
N	Non-ferreux															
S	Alliage réfractaire, Alliage titane															
H	Matières traitées / trempées															
Forme	Référence	Classe	Honing	Revêtu						Cermet	Carbure	Dimensions (mm)				Géométrie
				F7030	MC5020	VP15TF	UP20M	NX2525	NX4545	UTi20T	HTi10	IC	S	BS	RE	
	TECN1603PEFR1W	C	F								★	9.525	3.175	1.4	0.4	Face polie glacée 
	TECN1603PEER1W	C	E								★	9.525	3.175	1.4	0.4	
	TECN1603PETR1W	C	T						★	★	★	9.525	3.175	1.4	0.4	
	TEEN1603PEFR1	E	F								●	9.525	3.175	1.4	0.4	
	TEEN1603PEER1	E	E			★					●	9.525	3.175	1.4	0.4	
	TEEN1603PETR1	E	T				●	●	●	●	9.525	3.175	1.4	0.4		
	TEEN1603PESR1	E	S	●	●						9.525	3.175	1.4	0.4		
	TEEN1603PEZR1	E	Z					●			9.525	3.175	1.4	0.4		
	TECN2204PEFR1	C	F								★	12.7	4.76	1.4	1.0	
	TECN2204PEER1	C	E								★	12.7	4.76	1.4	1.0	
	TECN2204PETR1	C	T					★	★	★	12.7	4.76	1.4	1.0		
	TEEN2204PEFR1	E	F								●	12.7	4.76	1.4	1.0	
	TEEN2204PEER1	E	E			★					●	12.7	4.76	1.4	1.0	
	TEEN2204PETR1	E	T				●	●	●		12.7	4.76	1.4	1.0		
	TEEN2204PESR1	E	S	●	●						12.7	4.76	1.4	1.0		
	TEER1603PEER-JS	E	E	●							●	9.525	3.175	1.4	0.4	Plaquette représentée à droite. 
	TEER2204PEER-JS	E	E	●							★	12.7	4.76	1.4	1.0	

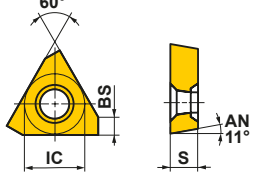
● : Article stocké. ★ : Article standard Japon.

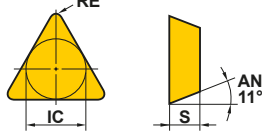
□ : Article non stocké - Fabrication sur commande uniquement. (10 plaquettes par boîte)

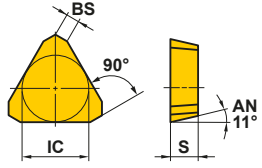
Matière	P	Acier											Conditions de coupe (Guide) : ● : Coupe Stable ● : Coupe Générale ✖ : Coupe Instable Honing : E : Arrondie T : Chanfrein	
	M	Acier Inoxydable												
K	Fonte													
N	Non-ferreux													
S	Alliage réfractaire, Alliage titane													
H	Matières traitées / trempées													
Forme	Référence	Classe	Honing	Revêtu				Cermet	Carbure	Dimensions (mm)				Géométrie
				F7030	VP15TF	UP20M	AP10H	NX2525	NX4545	UTi20T	HTi10	IC	S	
Angle d'attaque 0° 	TPEN1603PPR	E	T	●				●		9.525	3.18	1.2	—	
	TPEN1603PPN	E	T *1						●	9.525	3.18	1.2	—	
	TPEN2204PDR	E	T *1	●				● ●	●	12.7	4.76	1.4	—	
	TPEN2204PDL	E	T *1						□	12.7	4.76	1.4	—	
PMF K234 	TPEW1303ZPER2	E	E		●	●				7.94	3.18	2	—	
11° Positive 	TPMN160304	M	E *1	●	★	★		●	● ●	9.525	3.18	—	0.4	
	TPMN160308	M	E *2	●	★	●		●	● ●	9.525	3.18	—	0.8	
	TPMN160312	M	E *1			●			★	9.525	3.18	—	1.2	
	TPMN220404	M	E						●	12.7	4.76	—	0.4	
	TPMN220408	M	E *1	●	★	●			● ●	12.7	4.76	—	0.8	
	TPMN220408T	M	T					●		12.7	4.76	—	0.8	
	TPMN220412	M	E *1	★	★				● ●	12.7	4.76	—	1.2	
Angle d'attaque 0° 	TPNN2204PDR	N	E						●	12.7	4.76	1.4	—	

*1 La nuance HTi10 a une préparation d'arête "F".

*2 La nuance HTi10 a une préparation d'arête "F" et la nuance NX2525 "T".









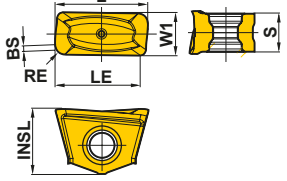

PLAQUETTES DE FRAISAGE

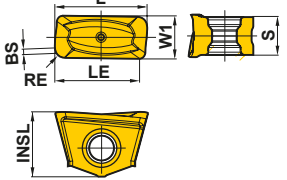
PLAQUETTES DE FRAISAGE

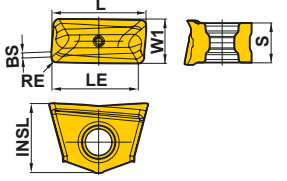

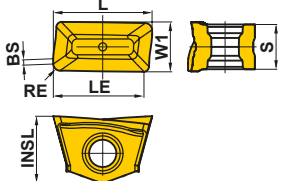
Matière	P	Acier									Conditions de coupe (Guide) : ● : Coupe Stable ● : Coupe Générale ✦ : Coupe Instable Honing : E : Arrondie F : Vive		
	M	Acier Inoxydable											
	K	Fonte											
N	Non-ferreux		✦ ✦			● ●							
S	Alliage réfractaire, Alliage titane												
H	Matières traitées / trempées												
Forme	Référence	Classe	Honing	Revêtu		Carbure		Dimensions (mm)					Géométrie
				MP9120	LC15TF	NEW	TF15	L	LE	S	BS	RE	
AXD4000 ↻K155 AXD4000A ↻K162	XDGX175004PDFR-GL	G	F	★			●	23.0	16.9	5	1.7	0.4	
	XDGX175008PDFR-GL	G	F	★			●	23.0	17.0	5	1.3	0.8	
	XDGX175012PDFR-GL	G	F	★			●	23.0	17.0	5	0.9	1.2	
	XDGX175016PDFR-GL	G	F	★			●	22.0	16.4	5	1.4	1.6	
	XDGX175020PDFR-GL	G	F	★			●	22.0	16.4	5	1.0	2.0	
	XDGX175024PDFR-GL	G	F	★			●	22.0	16.4	5	0.6	2.4	
	XDGX175030PDFR-GL	G	F	★			●	21.1	16.1	5	0.8	3.0	
	XDGX175032PDFR-GL	G	F	★			●	21.1	16.1	5	0.6	3.2	
	XDGX175040PDFR-GL	G	F	★			●	20.0	15.6	5	0.8	4.0	
XDGX175050PDFR-GL	G	F	★			●	19.4	15.3	5	0.4	5.0		
AXD4000 ↻K155 AXD4000A ↻K162	XDGX175004PDER-GM	G	E	●				23.0	17.0	5	1.7	0.4	
	XDGX175008PDER-GM	G	E	●				23.0	17.0	5	1.2	0.8	
	XDGX175012PDER-GM	G	E	●				23.0	17.0	5	0.9	1.2	
	XDGX175016PDER-GM	G	E	●				22.0	15.9	5	1.3	1.6	
	XDGX175020PDER-GM	G	E	●				22.0	15.9	5	0.8	2.0	
	XDGX175024PDER-GM	G	E	●				22.0	15.9	5	0.4	2.4	
	XDGX175030PDER-GM	G	E	●				21.1	16.0	5	0.6	3.0	
	XDGX175032PDER-GM	G	E	●				21.1	16.0	5	0.4	3.2	
	XDGX175040PDER-GM	G	E	●				20.0	14.8	5	0.5	4.0	
XDGX175050PDER-GM	G	E	●				19.4	15.0	5	0.3	5.0		
AXD4000 ↻K155 AXD4000A ↻K162	XDGX175004PDFR-GM	G	F			● ●		23.0	17.0	5	1.7	0.4	
	XDGX175008PDFR-GM	G	F			● ●		23.0	17.0	5	1.2	0.8	
	XDGX175012PDFR-GM	G	F			★ ●		23.0	17.0	5	0.9	1.2	
	XDGX175016PDFR-GM	G	F			● ●		22.0	15.9	5	1.3	1.6	
	XDGX175020PDFR-GM	G	F			● ●		22.0	15.9	5	0.8	2.0	
	XDGX175024PDFR-GM	G	F			★ ●		22.0	15.9	5	0.4	2.4	
	XDGX175030PDFR-GM	G	F			● ●		21.1	16.0	5	0.6	3.0	
	XDGX175032PDFR-GM	G	F			● ●		21.1	16.0	5	0.4	3.2	
	XDGX175040PDFR-GM	G	F			● ●		20.0	14.8	5	0.5	4.0	
XDGX175050PDFR-GM	G	F			★ ●		19.4	15.0	5	0.3	5.0		
AXD7000 ↻K166	XDGX227008PDFR-GL	G	F	★			●	30.0	21.6	7	2.0	0.8	
	XDGX227016PDFR-GL	G	F	★			●	30.0	21.7	7	1.2	1.6	
	XDGX227020PDFR-GL	G	F	★			●	30.0	21.7	7	0.8	2.0	
	XDGX227030PDFR-GL	G	F	★			●	28.8	21.2	7	0.8	3.0	
	XDGX227032PDFR-GL	G	F	★			●	28.8	21.2	7	0.6	3.2	
	XDGX227040PDFR-GL	G	F	★			●	27.5	20.6	7	0.9	4.0	
	XDGX227050PDFR-GL	G	F	★			●	27.0	20.3	7	0.4	5.0	

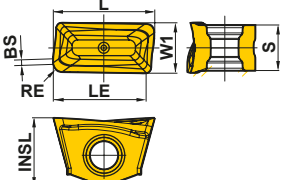
● ★ = NEW

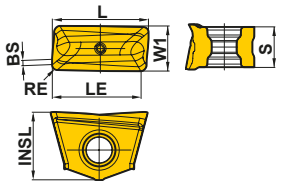
● : Article stocké. ★ : Article standard Japon.
 (10 plaquettes par boîte)

Matière	P	Acier	Classe	Honing	Revêtu	Dimensions (mm)							Géométrie
	M	Acier Inoxydable				L	LE	W1	INSL	S	BS	RE	
	K	Fonte											
	N	Non-ferreux											
	S	Alliage réfractaire, Alliage titane											
	H	Matières traitées / trempées											
VFX5 	XNMU160708R-MS	M	E	●		16.0	13.4	7.0	11.1	6.5	1.0	0.8	
	XNMU160712R-MS	M	E	●		16.0	13.8	7.0	11.1	6.5	1.0	1.2	
	XNMU160716R-MS	M	E	●		16.0	13.8	7.0	11.1	6.5	1.0	1.6	
	XNMU160724R-MS	M	E	●		16.0	13.8	7.0	11.1	6.5	1.0	2.4	
	XNMU160732R-MS	M	E	●		17.3	14.4	7.0	11.1	6.5	—	3.2	
	XNMU160740R-MS	M	E	●		18.9	15.2	7.0	11.1	6.5	—	4.0	
VFX5 	XNMU160708R-HS	M	E	●		16.0	13.4	7.0	11.1	6.5	1.0	0.8	
VFX5 	XNMU160708R-LS	M	E	●		16.0	13.4	7.0	11.1	6.5	1.0	0.8	
VFX6 	XNMU190912R-MS	M	E	●		19.1	16.5	9.5	12.7	8.5	1.0	1.2	
	XNMU190916R-MS	M	E	●		19.1	16.5	9.5	12.7	8.5	1.0	1.6	
	XNMU190924R-MS	M	E	●		19.1	16.6	9.5	12.7	8.5	1.0	2.4	
	XNMU190932R-MS	M	E	●		20.2	17.1	9.5	12.7	8.5	—	3.2	
	XNMU190940R-MS	M	E	●		21.8	17.8	9.5	12.7	8.5	—	4.0	
	XNMU190950R-MS	M	E	●		21.8	17.8	9.5	12.7	8.5	—	5.0	
VFX6 	XNMU190912R-HS	M	E	●		19.1	16.5	9.5	12.7	8.5	1.0	1.2	
VFX6 	XNMU190912R-LS	M	E	●		19.1	16.5	9.5	12.7	8.5	1.0	1.2	

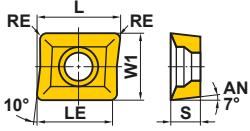
PLAQUETTES DE FRAISAGE

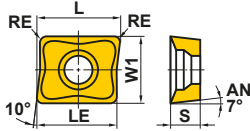
Matière	P	Acier	●	●	●	●	●	●	●	Conditions de coupe (Guide) : ● : Coupe Stable ● : Coupe Générale ✖ : Coupe Instable Honing : E : Arrondie			
	M	Acier Inoxydable	●	●	●	●	●	●	●				
Matière	K	Fonte	✖	✖	✖	✖	✖	✖	✖				
	N	Non-ferreux	●	●	●	●	●	●	●				
	S	Alliage réfractaire, Alliage titane	●	●	●	●	●	●	●				
H	Matières traitées / trempées	●	●	●	●	●	●	●	●				
Forme	Référence	Classe	Honing	Revêtu			Carbure	Dimensions (mm)					Géométrie
				F7030	VP15TF	UP20M	UT120T	L	LE	W1	S	RE	
DCCC ↻K200 	ZCMX083508ER-A	M	E	●			★	11	8.5	7.94	3.5	0.8	
	ZCMX09T308ER-A	M	E	●	●	●	★	12.7	11	9.525	3.97	0.8	
DCCC ↻K200 	ZCMX09T308ER-B	M	E	●	★			12.7	11	9.525	3.97	0.8	

PLAQUETTES DE FRAISAGE

● : Article stocké. ★ : Article standard Japon.
(10 plaquettes par boîte)







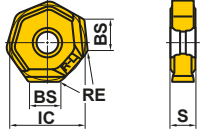
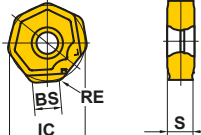

PLAQUETTES DE PLANAGE

Forme	Référence	Classe	Honing	Revêtement						Dimensions (mm)					Géométrie																																								
				MP6120	MC5020	VP15TF	NX2525	VP25N	HTi05T	L	W1	IC	S	BS		RE																																							
				●	●	●	●	●	●																																														
Matière		<table border="1"> <tr><td>P</td><td>Acier</td></tr> <tr><td>M</td><td>Acier Inoxydable</td></tr> <tr><td>K</td><td>Fonte</td></tr> <tr><td>N</td><td>Non-ferreux</td></tr> <tr><td>S</td><td>Alliage réfractaire, Alliage titane</td></tr> <tr><td>H</td><td>Matières traitées / trempées</td></tr> </table>		P	Acier	M	Acier Inoxydable	K	Fonte	N	Non-ferreux	S	Alliage réfractaire, Alliage titane	H	Matières traitées / trempées	<table border="1"> <tr><td>●</td><td>●</td><td>●</td><td>●</td><td>●</td><td>●</td></tr> <tr><td>●</td><td>●</td><td>●</td><td>●</td><td>●</td><td>●</td></tr> <tr><td>●</td><td>●</td><td>●</td><td>●</td><td>●</td><td>●</td></tr> <tr><td>●</td><td>●</td><td>●</td><td>●</td><td>●</td><td>●</td></tr> <tr><td>●</td><td>●</td><td>●</td><td>●</td><td>●</td><td>●</td></tr> <tr><td>●</td><td>●</td><td>●</td><td>●</td><td>●</td><td>●</td></tr> </table>		●	●	●	●	●	●	●	●	●	●	●	●	●	●	●	●	●	●	●	●	●	●	●	●	●	●	●	●	●	●	●	●	●	●	●	●	Conditions de coupe (Guide) : ● : Coupe Stable ● : Coupe Générale ✖ : Coupe Instable Honing : E : Arrondie T : Chanfrein	
P	Acier																																																						
M	Acier Inoxydable																																																						
K	Fonte																																																						
N	Non-ferreux																																																						
S	Alliage réfractaire, Alliage titane																																																						
H	Matières traitées / trempées																																																						
●	●	●	●	●	●																																																		
●	●	●	●	●	●																																																		
●	●	●	●	●	●																																																		
●	●	●	●	●	●																																																		
●	●	●	●	●	●																																																		
●	●	●	●	●	●																																																		
SE545	WEC53AFTR5C	C	T				★				18.505	15.875	—	4.76	5	1.0																																							
SE415	WEC42EFTR5C	C	T				★				13.728	12.7	—	3.18	5	1.0																																							
SE515	WEC53EFTR5C	C	T				★				16.903	15.875	—	4.76	5	1.0																																							
ASX445 ⓀK026	WEEW13T3AGER8C	E	E	●	●				●		16.6	16.48	—	3.97	7.5	1.5																																							
	WEEW13T3AGTR8C	E	T				●	●			16.6	16.48	—	3.97	7.5	1.5																																							
AHX440S ⓀK034	WNEU1305ZEN4C-M	E	E	●	●	★					—	—	13.4	5.1	4	2.7																																							
AHX640S ⓀK041	WNEU2007ZEN7C-M	E	E	●							—	—	20	6.9	7.2	0.8																																							

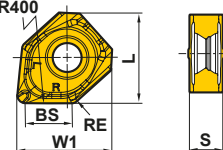
PLAQUETTES DE FRAISAGE

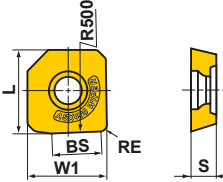
PLAQUETTES DE PLANAGE

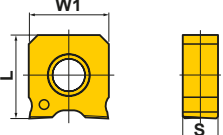

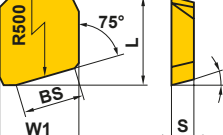







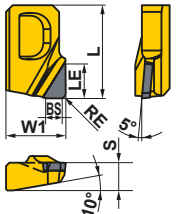

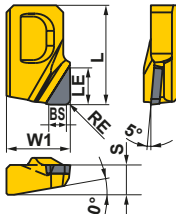
PLAQUETTES DE FRAISAGE

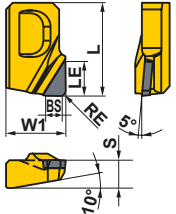
Forme	Référence	Classe	Honing	Revêtu			Cermet		Carbure	Dimensions (mm)						Géométrie	
				MC5020	MP6120	VP15TF	NX2525	MX3020	HT105T	L	W1	IC	S	BS	RE		
				Matière: P Acier, M Acier Inoxydable, K Fonte, N Non-ferreux, S Alliage réfractaire, Alliage titane, H Matières traitées / trempées Conditions de coupe (Guide): ●: Coupe Stable, ◐: Coupe Générale, ✦: Coupe Instable Honing: E: Arrondie, T: Chanfrein													
AHX640S ↻K041 AHX640W ↻K048 	WNEU2006ZEN7C-WK	E	E	●							-	-	20	6.55	7.4	0.8	
	WNEU2007ZEN7C-WP	E	E	●							-	-	20	6.9	7.1	0.8	
WSX445 ↻K016 	WNGU1406ANEN8C-M	G	E	● ● ●			●				16.87	16.87	-	6	8	1.0	
ASX400 ↻K068 	WOEW12T308PEER8C	E	E					●			13.2	12.5	-	3.97	8	0.8	
	WOEW12T308PETR8C	E	T				●				13.2	12.5	-	3.97	8	0.8	
VOX400 ↻K065 	WOEX1206PER5C	E	E	●							13.025	12.5	-	5.5	-	-	
FBP415 	WPC42EEER10C	C	E					●			15.163	12.5	-	3.175	10	-	

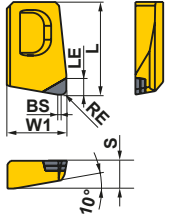
Plaquette représentée à droite.

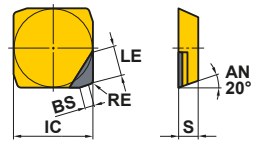
● : Article stocké. ★ : Article standard Japon.
 (10 plaquettes par boîte)

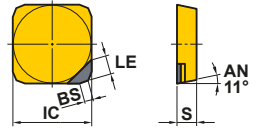

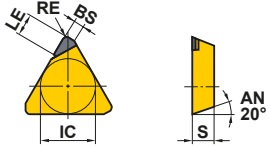
CBN ET PCD

Matière	K Fonte		● ●		Conditions de coupe (Guide):							Géométrie	
	N Non-ferreux		● ●		●: Coupe Stable ●: Coupe Générale ✦: Coupe Instable								
Forme	Référence	Classe	CBN		PCD		Dimensions (mm)						
			NEW MB4120 MB710		MD2030 MD220		L	LE	W1	IC	S	BS	RE
	GOER1404PXFR2	E			● ●	14.0	5.0	9.0	—	4.2	2.0	0.4	
	GOER1408PXFR2	E			● ●	14.0	5.0	9.0	—	4.2	2.0	0.8	
	GOER1408PXFR2-8	E			★	14.0	8.0	9.0	—	4.2	2.0	0.8	
	GOER1401ZXFR2	E			●	14.0	5.0	9.0	—	4.2	2.0	0.1	
	NP-GOEN1404PXSR05	E	●			14.0	2.5	9.0	—	4.2	0.5	0.4	
	NP-GOEN1408PXSR05	E	●			14.0	2.5	9.0	—	4.2	0.5	0.8	
	SECN1203EFFR1	C			★	—	5.0	—	12.7	3.18	1.4	1.0	
	SPEN1203EETR1	E	★			—	3.0	—	12.7	3.175	1.4	—	
	TECN1603PEFR1	C			★	—	5.0	—	9.525	3.175	1.4	0.4	

● ★ = NEW

● : Article stocké. ★ : Article standard Japon.
(Conditionnée par 1)

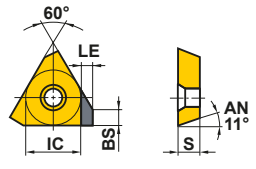
CBN ET PCD AVEC WIPER

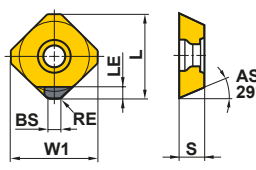
Matière	K Fonte		●	●	Conditions de coupe (Guide):							Géométrie
	N Non-ferreux				●: Coupe Stable ●: Coupe Générale ✚: Coupe Instable							
Forme	Référence	Classe	CBN		PCD		Dimensions (mm)					
			MB710	MD220	L	LE	W1	IC	S	BS	RE	
PMF ✚K234 	TPEW1303ZPTR2	E	●		—	1.5	—	7.94	3.18	2	—	
ASX445 ✚K026 	WEEW13T3AGFR3C	E		●	16.6	1.8	16.48	—	3.97	3.0	1.5	
	WEEW13T3AGTR3C	E	●		16.6	1.8	16.48	—	3.97	3.0	1.5	

PLAQUETTES DE FRAISAGE

Notes

A series of horizontal dashed lines for writing notes.

Notes

A series of horizontal dashed lines for writing notes, spanning the width of the page.

PIÈCES DÉTACHÉES

IDENTIFICATION N002

PIÈCES DÉTACHÉES

VIS DE FIXATION N003

VIS D'ATTACHEMENT N009

VIS / ÉCROU DE RÉGLAGE N010

ASSISE N011

GOUILLE / LEVIER N014

GOUILLE DE FIXATION N015

BRIDE DE SERRAGE N015

BRISE-COPEAUX N017

ANTI-GRIPPANT N018



IDENTIFICATION

IDENTIFICATION DES VIS DE SERRAGE (Filetage à droite métrique à pas fin)

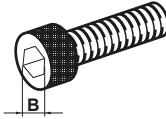

H SC 060 05

Longueur

Exemple	
Symbole	L
05	5
10	10
20	20
30	30

Diamètre vis

Exemple	
Symbole	d
050	M5
060	M6

Dimensions trou 6 pans

Diamètre	Pas	Dimensions B			
		HBH	HFC	HSC	HS \odot
M2	0.4	—	—	1.5	0.9
M2.5	0.45	—	—	2	1.3
M3	0.5	2	2	2.5	1.5
M4	0.7	2.5	2.5	3	2
M5	0.8	3	3	4	2.5
M6	1	4	4	5	3
M8	1.25	5	5	6	4
M10	1.5	6	6	8	5

PIÈCES DÉTACHÉES

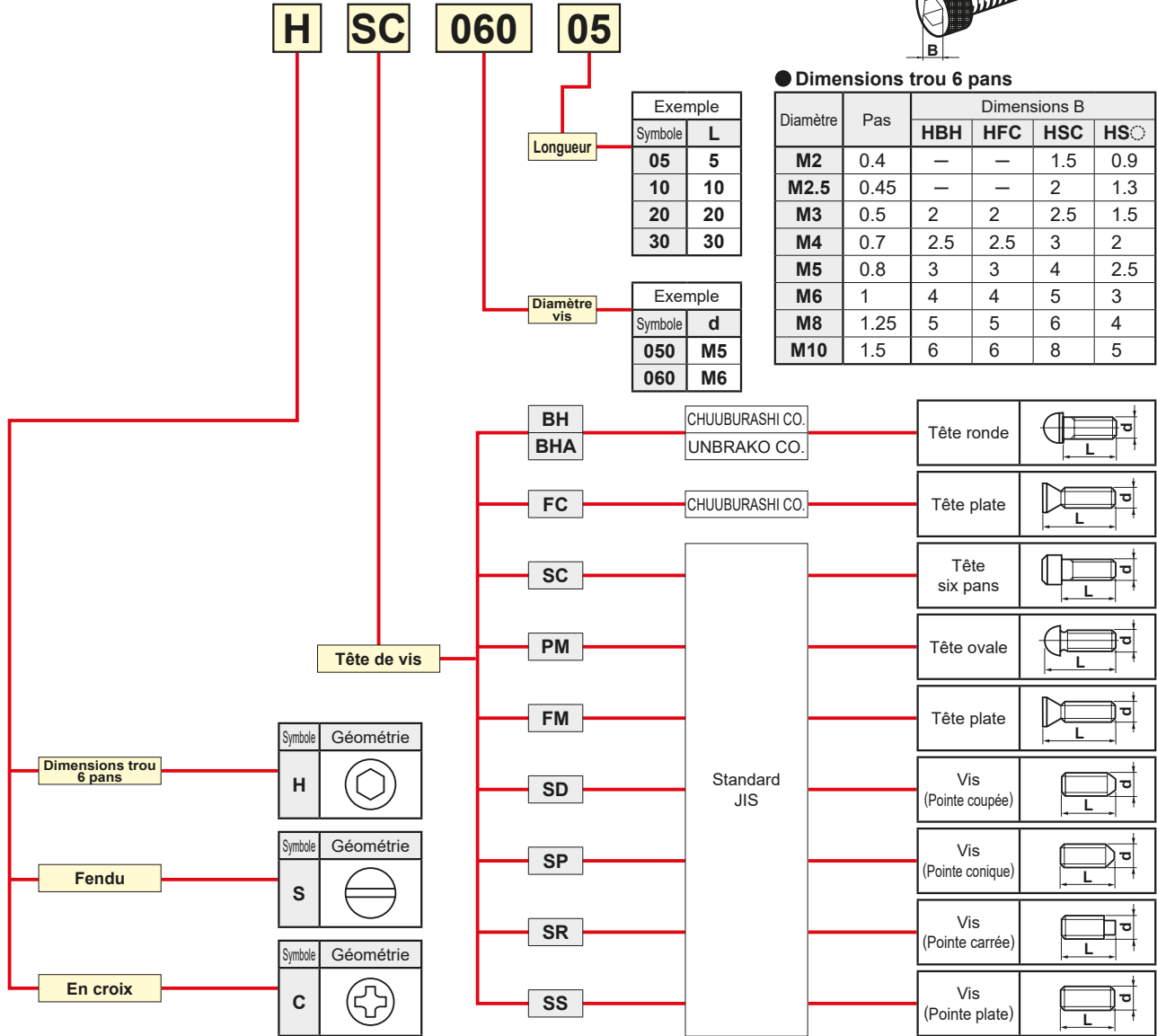

IDENTIFICATION CLÉ

HKY 15 R

Symbole	Clé
HKY	Clé hexagonale
TKY	Tournevis Torx
RKY	Tournevis R
TIP	Tournevis Torx plus

Clé hexagonale		
Symbole	B	
15	1.5	
20	2	
25	2.5	
30	3	
35	3.5	
40	4	
50	5	
60	6	

Tournevis Torx		
Symbole	B	Dimension
06	1.7	T6
08	2.3	T8
10	2.7	T10
15	3.3	T15
20	3.8	T20
25	4.4	T25
27	5.0	T27
30	5.5	T30

Tournevis Torx plus		
Symbole	B	Dimension
06	1.8	6IP
07	2.1	7IP
08	2.4	8IP
10	2.8	10IP
15	3.4	15IP

R	Clé allen	
L	Clé allen type long	
T	Clé T	
F	Clé drapeau	
FS	Clé drapeau	
W	Clé drapeau	
D	Tournevis	
DS	Tournevis	
S	Clé	

IMX 10 - WR

Symbole	Clé
IMX	Clé pour embouts iMX

Clé hexagonale	
Symbole	B
10	8
12	10
16	13
20	16
25	20

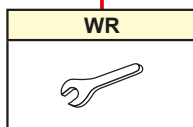

PIÈCES DÉTACHÉES

VIS DE FIXATION

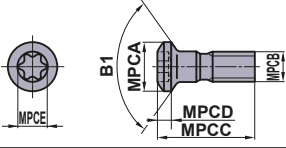
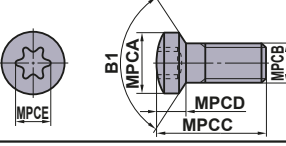
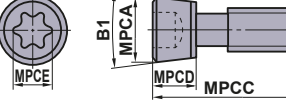
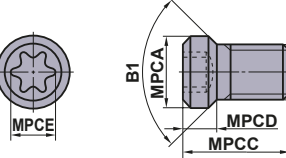
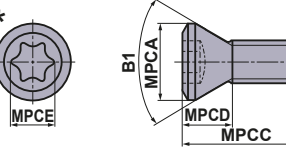
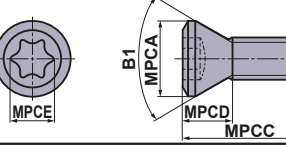
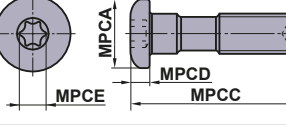
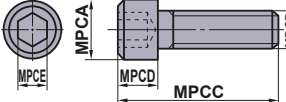

Géométrie	Référence	Dimensions (mm)					Angle B1	MPCOS	TQ (N·m)	Porte-outil
		MPCA	MPCB	MPCC	MPCD	MPCE				
	AJS3010T10	5	M3×0.5	10	1.5	2.8	120°	T10	2.5	Porte-outil Profil (⊕C032) AJX (⊕K180) AJX (⊕K180)
	AJS4012T15	7	M4×0.7	12	2.2	3.4	120°	T15	3.5	
	AJS5014T25	8	M5×0.8	14	2.7	4.5	120°	T25	7.5	
	BRS103	5	M3×0.5	9.9	2.9	3.4	120°	T15	3.5	
	BRS105	8	M5×0.8	13.8	3.8	4.5	120°	T25	7.5	
	CAS51T	7.9	M5×0.8	19	5	4.5	10°	T25	8.5	
 	CS200T	3.2	M2×0.4	5	1.6	1.8	90°	T6	0.6	Barre d'alésage F (⊕E027)
	CS250T	3.7	M2.5×0.45	6	1.8	2.4	90°	T8	1.0	Outils de fraisage (⊕K001) BRP (⊕K190)
	* CS250560T	3.9	M2.5×0.45	5.2	2.5	2.4	60°	T8	1.0	
	CS300590T	4.1	M3×0.5	5.5	2.1	2.4	90°	T8	1.0	DCCC (⊕K200)
	CS300790TS	4.7	M3×0.5	7	2.3	2.8	90°	T10	2.0	
	CS300890T	4.1	M3×0.5	8	2.1	2.4	90°	T8	1.0	
	CS350690T	4.8	M3.5×0.6	6.5	2.4	2.8	90°	T10	2.5	Barre d'alésage MMTI (⊕G026) BRP (⊕K190) DCCC (⊕K200)
	* CS350760T	5.5	M3.5×0.6	7	4.0	3.4	60°	T15	3.5	
	CS350790T	4.8	M3.5×0.6	7	2.4	2.8	90°	T10	3.5	
	* CS350860T	5.5	M3.5×0.6	8.4	4.0	3.4	60°	T15	3.5	Porte-outil type AL (⊕C034) AHX640S (⊕K041)
	CS350990T	4.8	M3.5×0.6	9	2.4	2.8	90°	T10	2.5	
	CS400990T	6.0	M4×0.7	9	2.8	3.4	90°	T15	3.5	
	CS401160T	5.7	M4×0.7	11	4.5	3.4	60°	T15	3.5	Porte-outil type AL (⊕C034) AHX640S (⊕K041)
	CS401990T	6.0	M4×0.7	19	3.0	3.9	90°	T20	3.5	
	CS451190T	6.3	M4.5×0.75	11	2.9	3.9	90°	T20	5.0	
	* CS501160T	7.0	M5×0.8	11	3.6	3.9	60°	T20	5.0	AHX640S (⊕K041)
CS501290T	7.0	M5×0.8	11	3.5	4.5	90°	T25	7.5		
* CS5015060T	7.2	M5×0.8	15	2.4	3.9	60°	T20	5.0		
CS502190T	8.5	M5×0.8	21	4.0	5.1	90°	T27	7.5	PMR (⊕K236)	
CS6016060T	8.5	M6×1.0	16	4.5	4.5	60°	T25	7.5		
	CSF401260T	7.2	M4×0.5	12	5.2	3.9	60°	T20	5.0	
	DC0520T	8.5	M5×0.8	22.5	2.5	3.4	—	T15	3.5	Porte-outil DOUBLE-FORCE (⊕C008)
	DC0621T	10.5	M6×1.0	25	4	3.9	—	T20	5.0	BARRE D'ALÉSAGE DIMPLE BAR (⊕E015) Porte-outil HSK (⊕H001)
	DKS4	5.6	M4×0.7	18	3.5	3	—	—	3.3	
DKS5	7.6	M5×0.8	19	4.5	4	—	—	7.0		

N

PIÈCES DÉTACHÉES

PIÈCES DÉTACHÉES

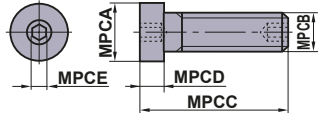
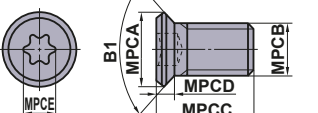
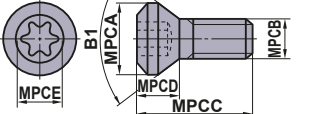
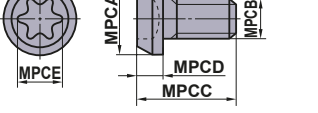
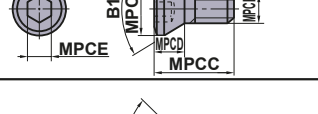
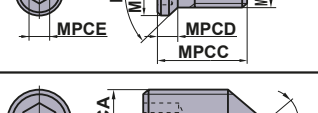
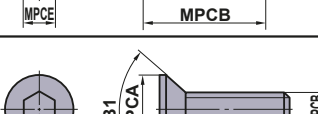
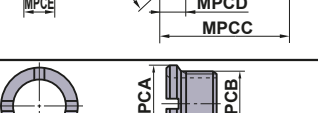
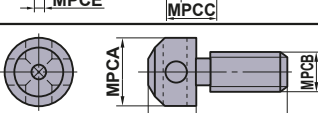
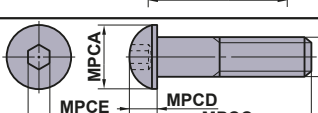
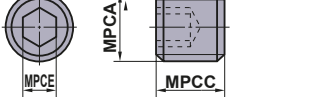
VIS DE FIXATION

Géométrie	Référence	Dimensions (mm)					Angle	MPCOS	TQ (N·m)	Porte-outil
		MPCA	MPCB	MPCC	MPCD	MPCE	B1			
	EGS06019	9	M6×1	22.5	3.5	3	—	—	3.3	
	EGS08024	11	M8×1.25	28.5	4.5	4	—	—	7.0	
	FC400890T	5.6	M4×0.7	7.5	1.3	2.8	90°	T10	2.5	Porte-outil type AL (☉C035) Barre d'alésage AL (☉E041)
	GY05016S	8.7	M5×0.8	16	3.5	3.9	90°	T20	5.0	Série GY (☉F004)
	GY06013M	12	M6×1	18	5	5.6	—	T30	6.0	Série GY (☉F004)
	HFF06015	10	M6×1	15	6	5	80°	—	8.2	
	HS4L	5.4	M4×0.7	14	2.3	2.5	80°	—	3.8	
	HS5S	6.8	M5×0.8	9	2.8	3	80°	—	3.3	
	HS5L	6.8	M5×0.8	15	2.8	3	80°	—	6.6	
	HSP05008C	M5×0.8	8	—	—	2.5	—	—	2.5	Porte-outil type MP (☉C019)
	HY-A1	4.4	M3×0.5	7	2.1	2	82°	—	1.5	
	HY-V1	5.5	M3×0.5	7	2.5	2	82°	—	1.5	
	HY2	5.5	M3×0.5	10	2.5	2	82°	—	1.5	
	HY3	7	M3.5×0.6	12	2.9	2	82°	—	1.5	
	HY4	9.3	M5×0.8	16	3.6	3	82°	—	3.3	
	JSS6	6.9	M6×0.75	4.5	1.5	0.8	—	—	—	
	JSS7	8	M7×0.75	4.4	1.5	1	—	—	—	
	KS1	7	M4×0.7	14	5	—	—	—	—	
	KS2	10	M6×1	18	7	—	—	—	—	
	KS2S	10	M6×1	18	7	—	—	—	—	
	KS12	10	M6×1	26	4	4	—	—	7.0	
	LLR1	M5×0.8	—	3.5	—	2.5	—	—	—	
	LLR2	M6×1	—	5	—	3	—	—	—	

N

PIÈCES DÉTACHÉES

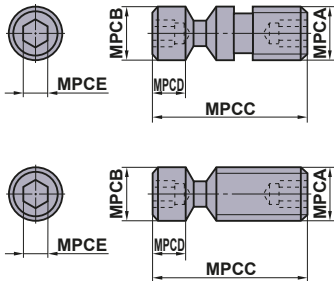
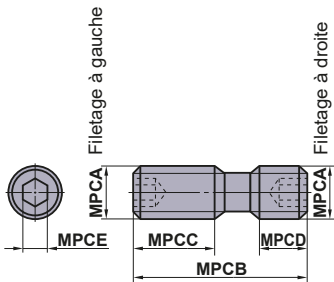
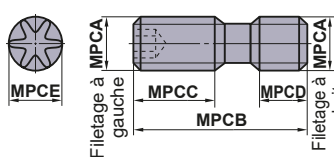
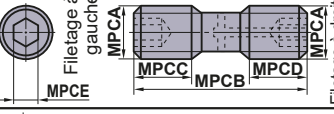
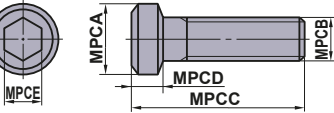
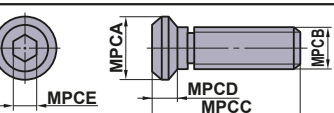
Géométrie	Référence	Dimensions (mm)					Angle B1	MPCOS	TQ (N·m)	Porte-outil
		MPCA	MPCB	MPCC	MPCD	MPCE				
 <p>LLCS103, LLCS105 LLCS112, LLCS125 LLCS205</p> <p>Les produits ayant une "*" ne sont pas pourvus du trou marqué de la lettre MPCB à l'extrémité.</p> <p>Les produits ayant une "☆" ne sont pas pourvus du trou marqué de la lettre MPCA à l'extrémité.</p>	☆ LLCS103	M3×0.5	4	11	4.6	2	—	—	1.5	Barre d'alésage P (⊕E037) Porte-outil HSK (⊕H001)
	* LLCS105	M5×0.8	M5×0.8	10	1.5	2	—	—	1.5	
	LLCS106	M6×1	6	16.5	3.5	2.5	—	—	2.2	
	* LLCS106S	M6×1	6	13.4	0.7	2.5	—	—	2.2	
	LLCS108	M8×1.25	8	21	6.5	3	—	—	3.3	
	* LLCS108S	M8×1.25	8	16.5	2	3	—	—	3.3	
	LLCS110	M10×1.5	10	29	8	4	—	—	7.0	
	LLCS112	M12×1	11.9	36.2	9	5	—	—	8.0	
	LLCS125	M5×0.8	M5×0.8	12	2	2	—	—	1.5	
	LLCS205	M5×0.8	M5×0.8	16	4	2	—	—	1.5	
	LLCS206	M6×1	6	26	13	2.5	—	—	2.2	
	LLCS208	M8×1.25	8	24	6.5	3	—	—	3.3	
	LLCS306	M6×1	6	21	4	2.5	—	—	2.2	
	LLCS308	M8×1.25	8	42	27.5	3	—	—	3.3	
	LLCS310	M10×1	10	29	8	4	—	—	7.0	
	LLCS410	M10×1	10	30	6.6	4	—	—	7.0	
	LLCS508	M8×1	8	24	6.5	3	—	—	3.3	
	* LLCS508S	M8×1	8	20.5	3	3	—	—	3.3	
 <p>*Sans empreinte hexagonale côté filetage à droite</p>	LS1	M6×1	22	8	8	3	—	—	5.0	Outils de fraisage (⊕K001)
	LS2	M8×1	29	13	10	4	—	—	8.2	
	LS3	M8×1	32	13	13	4	—	—	8.2	
	* LS4	M6×1	15	8	4	3	—	—	5.0	
	* LS5	M6×1	18	8	5	3	—	—	5.0	
	* LS6	M8×1	24	13	5	4	—	—	8.2	
	* LS7	M8×1	27	13	8	4	—	—	8.2	
	* LS8	M6×0.75	18	7	7	3	—	—	5.0	
	* LS9	M6×0.75	22	8	8	3	—	—	5.0	
	* LS10	M7×0.75	16	6	6	4	—	—	8.2	
	* LS11	M8×1	16	6	6	4	—	—	7.8	
	* LS12	M8×1	24	7	7	4	—	—	7.8	
	* LS13	M8×1	34	12	12	4	—	—	7.8	
	* LS14	M7×0.75	24	10	10	4	—	—	7.8	
	* LS16	M7×0.75	23	11	8	4	—	—	7.8	
	* LS18	M7×0.75	14	6	4	4	—	—	7.8	
	* LS20	M10×1.5	26	9	9	5	—	—	9.0	
	* LS21	M10×1.5	32	12	12	5	—	—	9.0	
LS24	M8×1.25	24	8.5	8.5	4	—	—	7.8		
LS25	M8×1	28.5	12.0	10.5	4	—	—	8.2		
	LS10T	M7×0.75	14	6	5	4.5	—	T25	8.0	Porte-outil DOUBLE-FORCE (⊕C009)
	LS14T	M7×0.75	24	10	10	4.5	—	T25	8.0	
	LS15T	M7×0.75	18	7	7	4.5	—	T25	8.0	
	LS19T	M6×0.75	11	4	4	3.4	—	T15	5.0	
	LS10TS	M7×0.75	13	6	4	4.5	—	T25	8.5	
	LS0622T	M6×0.75	22	8	8	3.4	—	T15	6.0	
	LS24H	M8×1.25	24	8.5	8.5	4	—	—	8.2	
	MGS6	10	M6×1	26	4	5	—	—	9.0	APX3000 (⊕K133)
	MHT1	11	M8×1	18.5	3.5	4	—	—	8.7	

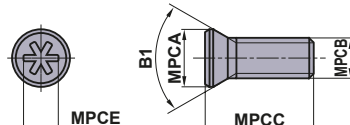
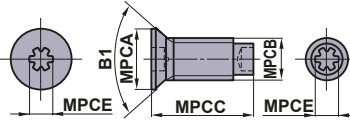
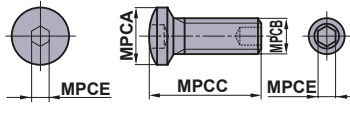
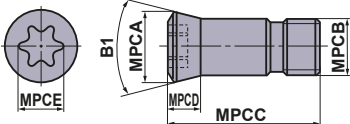
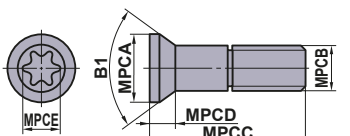
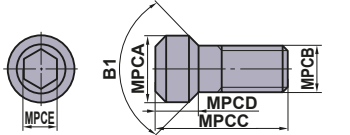
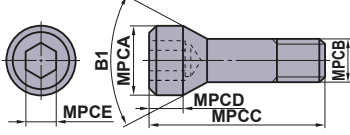
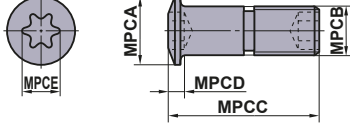
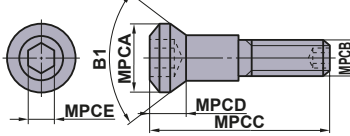
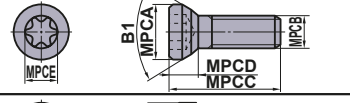
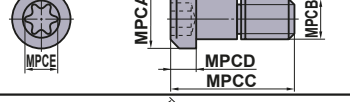
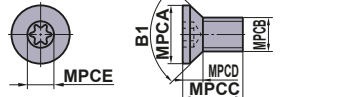

PIÈCES DÉTACHÉES

VIS DE FIXATION

Géométrie	Référence	Dimensions (mm)					Angle B1	MPCDS	TQ (N·m)	Porte-outil
		MPCA	MPCB	MPCD	MPCCE	MPCC				
	NS251	3.6	M2.5×0.45	7	—	2.2	60°	—	0.7	BTVH (⊕D016) CSVH (⊕D027) CTAH-S (⊕D020)
	NS401	5.8	M4×0.7	6	—	3.6	60°	—	3.5	
	NS402W	5.85	M4×0.7	10	—	2.2	60°	—	0.7	CTAH (⊕D020) CTBH (⊕D022)
	NS403W	5.85	M4×0.7	12	—	2.2	60°	—	0.7	
	NS404W	5.8	M4×0.7	10	—	2.2	90°	—	0.7	
	NS501W	8	M5×0.8	16	—	2.5	120°	—	2.2	OUTILS MINI (⊕D001)
	NS502W	8	M5×0.8	20	—	2.5	120°	—	2.2	
	RN-S6	9.5	M6×0.75	20.3	4.6	3.9	61°	T20	5.0	
	RN-S7	11	M7×0.75	24.7	5.2	4.5	61°	T25	7.5	
	RS3008T	4.3	M3×0.35	8.6	2	2.4	61°	T8	1.5	SRF (⊕K212) SUF (⊕K216)
	RS3510T	5	M3.5×0.35	10	2.3	2.8	61°	T10	2.5	
	RS4015T	6	M4×0.5	14	2.7	3.4	61°	T15	3.3	
	RS5020T	8.1	M5×0.5	16.4	3.6	3.9	61°	T20	5.0	
	RS6025T	9.5	M6×0.75	21.5	4.2	4.5	61°	T25	7.5	
	RS8030T	12	M8×0.75	25	5	5.6	61°	T30	10.0	
	S1	3.5	M2×0.4	5.5	2.2	1.5	92°	—	0.6	
	S3	4.5	M3×0.5	7.7	2.4	2	92°	—	1.5	
	S4	5.3	M4×0.7	8	1.8	2.5	62°	—	2.2	
	S5	6.8	M5×0.8	9	2.4	3	62°	—	3.3	
	SD32	12	M8×1.25	28	7.2	6	50°	—	9.5	
	SD40	12	M8×1.25	36	7.2	6	50°	—	9.5	
	SD50	16	M10×1.5	46	8.2	8	50°	—	1.0	
	SD63	16	M10×1.5	61	8.2	8	50°	—	1.0	
	SETS51	6.8	M5×0.8	14.8	1.5	3.4	—	T15	3.5	Porte-outil type MMTE (⊕G019) Barre d'alésage MMTI (⊕G026) Porte-outil HSK (⊕H001)
	SETS61	8	M6×1	20	1.8	3.9	—	T20	5.0	
	SLCS105	10	M5×0.8	25	6.3	4	90°	—	7.0	Porte-outil type WP (⊕C017)
	SLCS106	12	M6×1	32	6.2	4	90°	—	7.0	
	SPS1	8.5	M5×0.8	16	4	4.5	70°	T25	5.0	
	SRS5	6.7	M5×0.8	16	3.5	3.9	—	T20	5.0	
	STS1	6.8	M3×0.5	7	2.2	2.8	90°	T10	2.5	

PIÈCES DÉTACHÉES

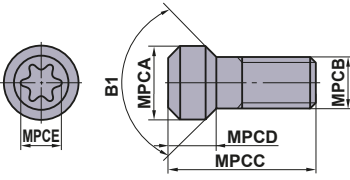
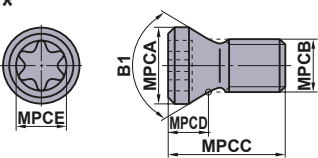
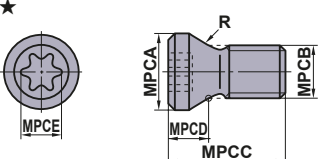
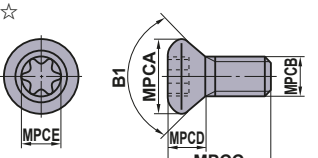
N

Géométrie	Référence	Dimensions (mm)					Angle	MPCCS	TQ (N.m)	Porte-outil
		MPCA	MPCB	MPCC	MPCD	MPCE				
	* TS16	2.5	M1.6×0.35	3.2	1.6	1.8	60°	T6	0.6	MICRO-DEX (☉E018)
	TS2	2.7	M2×0.4	4.6	1.4	1.8	60°	T6	0.6	
	* TS2A	2.7	M2×0.4	4.5	1.2	1.8	60°	T6	0.6	AQX (☉K172)
	TS2C	2.7	M2×0.4	3.8	1.4	1.8	60°	T6	0.6	
	☆ TS2D	3.8	M2×0.4	5.3	1.9	1.8	82°	T6	0.6	DIMPLE BARRE (☉E007)
	TS21	2.7	M2×0.4	3.4	1.4	1.8	60°	T6	0.6	Barre d'alésage F (☉E029)
	* TS22	3.0	M2.2×0.45	5	1.2	1.8	60°	T6	0.6	Barre d'alésage S (☉E030)
	* TS25	3.3	M2.5×0.45	5.5	1.7	2.4	60°	T8	1.0	AQX (☉K172) AJX (☉K180)
	☆ TS25D	4.4	M2.5×0.45	6.2	2.2	2.4	82°	T8	1.0	Barre d'alésage MMTI (☉G026)
	* TS25H	3.6	M2.5×0.45	5.5	2	2.4	60°	T8	1.0	SRM2 (☉K220)
	TS202	2.7	M2×0.4	5.5	1.8	1.8	60°	T6	0.6	
	TS253	3.3	M2.5×0.45	4.5	1.7	2.4	60°	T8	1.0	Outils de fraisage (☉K001)
	TS254	3.3	M2.5×0.45	7	1.7	2.4	60°	T8	1.0	OUTILS MINI (☉D001) PMF (☉K234)
	* TS255	3.5	M2.5×0.45	7.5	1.6	2.4	60°	T8	1.0	Porte-outil Profil (☉C032)
	TS3	3.9	M3×0.5	6	2	2.4	60°	T8	1.0	TSMP (☉K232)
	TS304	3.9	M3×0.5	10.5	2.0	2.4	60°	T8	1.5	
	TS3D	5.0	M3×0.5	6	2.3	2.8	82°	T10	2.5	DIMPLE BARRE (☉E007)
	* TS3SB	4.4	M3×0.5	8	2	2.4	80°	T8	1.5	AXD4000 (☉K155)
	TS3SBS	4.4	M3×0.5	6.5	2	2.4	80°	T8	1.5	AXD4000 (☉K155)
	☆ TS31D	4.8	M3×0.5	7.2	2.2	2.8	82°	T10	2.5	DIMPLE BARRE (☉E007)
	* TS32	3.9	M3×0.5	7.5	2	2.4	60°	T8	2.0	SRM2 (☉K220)
	* TS33	3.9	M3×0.5	6.7	2	2.4	60°	T8	1.5	AQX (☉K172) AJX (☉K180)
	TS35	4.8	M3.5×0.6	6.5	2.4	2.8	60°	T10	2.5	
	* TS35D	5.3	M3.5×0.6	12	2.8	3.4	60°	T15	3.5	Porte-outil HSK (☉H001)
	★ TS35R	5.7	M3.5×0.6	10	2.1	3.4	—	T15	3.5	AHX440S (☉K034) AHX475S (☉K038)
	TS351	4.8	M3.5×0.6	7.2	2.4	2.8	60°	T10	2.5	AJX (☉K180) SRM2 (☉K220)
	TS352	4.8	M3.5×0.6	10	3	2.8	60°	T10	2.5	VFX5 (☉K192)
	TS4S	5.4	M4×0.7	7	2.4	3.4	80°	T15	3.5	
	* TS4SL	5.4	M4×0.7	8	2.4	3.4	80°	T15	4.0	
	* TS4SB	5.8	M4×0.7	9	2.7	3.4	80°	T15	3.5	AXD7000 (☉K166)
	* TS4SBL	5.8	M4×0.7	10.5	2.7	3.4	80°	T15	3.5	Série GY (☉F004) AXD7000 (☉K166)
	TS4	5.4	M4×0.7	8	2.6	3.4	60°	T15	3.5	CE/CF/CGSP (☉K230) TSMP (☉K232)
	TS4D	5.6	M4×0.7	7.7	2.5	3.4	82°	T15	3.5	DIMPLE BARRE (☉E007)
	TS42	5.4	M4×0.7	6	2.6	3.4	60°	T15	3.5	
	TS43	5.4	M4×0.7	10	2.6	3.4	60°	T15	3.5	AJX (☉K180) BRP (☉K190) SRM2 (☉K220)
	TS44	5.4	M4×0.7	12	2.6	3.4	60°	T15	3.5	
	TS406	5.4	M4×0.7	15.5	2.6	3.4	60°	T15	3.5	
	TS407	5.4	M4×0.7	9	2.6	3.4	60°	T15	3.5	AQX (☉K172) AJX (☉K180)
	TS450	5.9	M4.5×0.75	13	3.6	3.9	60°	T20	5.0	VFX6 (☉K196)
	TS5S	6.8	M5×0.8	9	2.9	4.5	80°	T25	7.5	
	* TS5SL	6.8	M5×0.8	12	2.9	4.5	80°	T25	7.5	
	TS5	6.8	M5×0.8	9	3.2	4.5	60°	T25	7.5	Porte-outil SP (☉C024) CE/CF/CGSP (☉K230) TSMP (☉K232)
	TS5L	6.8	M5×0.8	15	2.9	4.5	80°	T25	7.5	
	★ TS5R	6.9	M5×0.8	12	3.5	3.9	—	T20	5.0	WWX400 (☉K056) WJX (☉K072)
	TS52	6.8	M5×0.8	8	3.2	4.5	60°	T25	7.5	CE/CF/CGSP (☉K230)
	TS53	6.8	M5×0.8	16	3.2	4.5	60°	T25	7.5	
	TS54	6.8	M5×0.8	12	3.2	4.5	60°	T25	7.5	AJX (☉K180)
	TS55	6.8	M5×0.8	10.5	3.2	4.5	60°	T25	7.5	Série GY (☉F004) AQX (☉K172) SPX (☉K203) SRM2 (☉K220)
	* TS6S	8.5	M6×1.0	13	4.4	5.6	60°	T30	10.0	AQX (☉K172) SRM2 (☉K220)
	* TS6	8.5	M6×1.0	16	4.4	5.6	60°	T30	10.0	SRM2 (☉K220)

N

PIÈCES DÉTACHÉES

PIÈCES DÉTACHÉES

VIS DE FIXATION

PIÈCES DÉTACHÉES

N

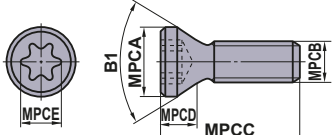
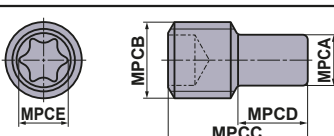
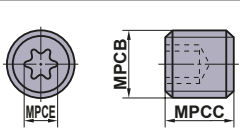
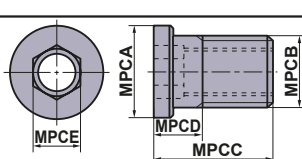
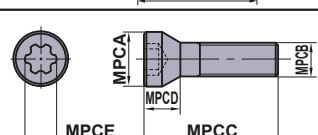
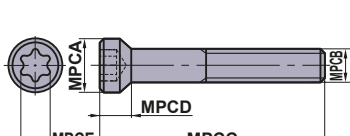
Géométrie	Référence	Dimensions (mm)					Angle B1	MPCDS	TQ (N·m)	Porte-outil
		MPCA	MPCB	MPCD	MPCD	MPCD				
	TPS20	2.7	M2×0.4	3.5	1.3	1.8	60°	6IP	0.5	
	TPS20-1	2.65	M2×0.4	4.7	2.4	1.8	60°	6IP	0.6	MVX (⊕M160)
	TPS22	3.0	M2.2×0.45	4.7	1.6	2.1	60°	7IP	0.5	
	TPS22S	3.0	M2.2×0.45	4.2	1.6	2.1	60°	7IP	0.5	
	TPS25	3.3	M2.5×0.45	5.5	1.7	2.1	60°	7IP	1.0	APX3000 (⊕K133) MVX (⊕M160)
	TPS25-1	3.3	M2.5×0.45	6.5	1.7	2.1	60°	7IP	1.0	APX3000 (⊕K133)
	TPS27F1	3.7	M2.7×0.35	6.5	1.8	2.1	60°	7IP	1.0	VPX200 (⊕K086)
	TPS27F2	3.7	M2.7×0.35	8.0	1.8	2.1	60°	7IP	1.0	VPX300 (⊕K100)
	TPS3	3.9	M3×0.5	6.7	1.4	2.82	60°	10IP	1.0	MVX (⊕M160)
	* TPS3R	4.6	M3×0.5	8.5	1.4	2.82	—	10IP	2.0	WJX09 (⊕K072)
	TPS3SB	4.4	M3×0.5	8	2.0	2.82	80°	10IP	3.0	AXD4000A (⊕K162)
	TPS35	5.3	M3.5×0.6	11.5	2.8	3.4	60°	15IP	3.5	ASX445 (⊕K026) ASX400 (⊕K068) PMR (⊕K236)
	TPS351	4.8	M3.5×0.6	7.2	1.4	2.82	60°	10IP	2.5	MVX (⊕M160)
	TPS351B	5.1	M3.5×0.6	7.2	1.4	2.82	60°	10IP	2.5	ARP (⊕K238)
	TPS4	5.3	M4×0.7	8	2.6	3.4	60°	15IP	3.5	APX4000 (⊕K140) ARP (⊕K238) MVX (⊕M160)
	TPS40F1	5.3	M4×0.5	10.5	2.8	3.4	60°	15IP	3.0	VPX300 (⊕K100)
TPS43	5.3	M4×0.7	10	2.6	3.4	60°	15IP	4.0	APX4000 (⊕K140) MVX (⊕M160)	
* TPS4R	6.4	M4×0.7	10.6	2.9	3.4	—	15IP	3.5	WSX445 (⊕K016)	
TPS54	6.8	M5×0.8	12	3.2	4.5	60°	25IP	7.5	MVX (⊕M160)	
	TSR05008S	3.5	M5×0.8	8	—	2.8	—	T10	—	
	TSR06011S	4	M6×1.0	11	—	3.9	—	T20	—	
	TSS04005	—	M4×0.7	5	—	2.4	—	T8	—	PMF (⊕K234)
	TSS04505S	—	M4.5×0.7	5	—	3.5	—	T10	3.5	FMAX (⊕K051)
	TSS05006	—	M5×0.8	6	—	2.8	—	T10	—	
	TSS06010	—	M6×1	10	—	3.9	—	T20	—	
	WCS503507H	6.3	M5×0.5	7	3.3	3.5	—	—	5.0	ASX445 (⊕K026) ASX400 (⊕K068) PMR (⊕K236)
	WCS604010H	7.8	M6×0.75	10	4.1	4.0	—	—	7.0	PMR (⊕K236)
	WS203107TPS	3.1	M2×0.25	7.3	1.7	1.8	60°	6IP	1.0	STAW (⊕M141)
	WS203108TPS	3.1	M2×0.25	8.3	1.9	1.8	60°	6IP	1.0	
	WS253909TPS	3.9	M2.5×0.35	9.5	2.4	2.4	60°	8IP	2.0	
	WS304912TPS	4.9	M3×0.35	12	3.25	2.82	60°	10IP	2.5	
	WS254012T	4	M2.5×0.45	11.5	2.2	2.4	80°	T8	2.0	TAW (⊕M150)
	WS254013T	4	M2.5×0.45	12.5	2.2	2.4	80°	T8	2.0	
	WS254014T	4	M2.5×0.45	13.5	2.2	2.4	80°	T8	2.0	
	WS254015T	4	M2.5×0.45	14.5	2.2	2.4	80°	T8	2.0	
	WS254016T	4	M2.5×0.45	15.5	2.2	2.4	80°	T8	2.0	
	WS304517T	4.5	M3×0.5	16.5	3.4	2.8	60°	T10	3.5	
	WS304518T	4.5	M3×0.5	17.5	3.4	2.8	60°	T10	3.5	
	WS355520T	5.5	M3.5×0.6	19.5	3.9	3.4	60°	T15	5.5	
	WS355521T	5.5	M3.5×0.6	20.5	3.9	3.4	60°	T15	5.5	
	WS406023T	6	M4×0.7	22.0	4.4	4.5	60°	T25	8.5	
	WS406024T	6	M4×0.7	23.0	4.4	4.5	60°	T25	8.5	
	WS508026T	8	M5×0.8	25.0	5.2	5.1	60°	T27	12.0	
WS508027T	8	M5×0.8	26.0	5.2	5.1	60°	T27	12.0		

VIS D'ATTACHEMENT

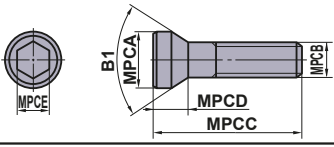
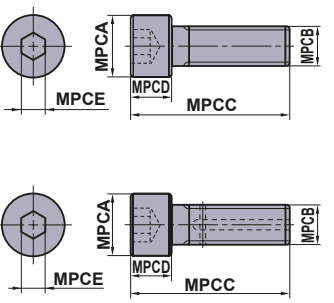
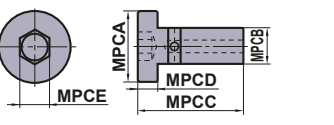
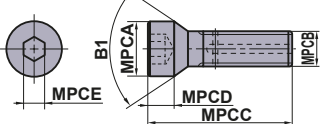
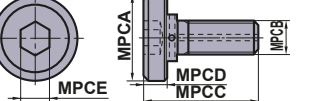
Géométrie	Référence	Dimensions (mm)					Angle	MPCDS	TQ (N·m)	Porte-outil
		MPCA	MPCB	MPCC	MPCD	MPCE				
	BOES101	15	M10×1.5	45	10	8	60°	—	10.0	
	* HSC08025H	13	M8×1.25	33	8	5	—	—	24	VPX200/300 (⊕K086,K100) ARP (⊕K238)
	HSC05030	8.5	M5×0.8	35	5	4	—	—	10	APX3000/4000 (⊕K133,K140)
	* HSC08030H	13	M8×1.25	38	8	5	—	—	24	WSX445 (⊕K016)
	HSC08045	13	M8×1.25	53	8	5	—	—	24	VPX200/300 (⊕K086,K100)
	HSC08040	13	M8×1.25	48	8	5	—	—	24	WSX445 (⊕K016)
	HSC08050	13	M8×1.25	58	8	5	—	—	24	VPX200/300 (⊕K086,K100)
	* HSC10030H	16	M10×1.5	40	10	6	—	—	40	APX3000/4000 (⊕K133,K140) AJX (⊕K180) WSX445 (⊕K016)
	HSC10035	16	M10×1.5	45	10	6	—	—	44	VFX5 (⊕K192) VFX6 (⊕K196)
	HSC10050	16	M10×1.5	60	10	8	—	—	44	APX3000/4000 (⊕K133,K140) VPX200/300 (⊕K086,K100)
	HSC10055	16	M10×1.5	65	10	8	—	—	44	VFX5 (⊕K192)
	HSC10060	16	M10×1.5	70	10	8	—	—	44	VPX200/300 (⊕K086,K100)
	HSC10070	16	M10×1.5	80	10	8	—	—	44	VPX200/300 (⊕K086,K100) ASPX (⊕K028)
	HSC12035	18	M12×1.75	47	12	10	—	—	80	WSX445 (⊕K016)
	* HSC12035H	18	M12×1.75	47	12	10	—	—	80	APX3000/4000 (⊕K133,K140) AJX (⊕K180)
	HSC12040	18	M12×1.75	52	12	10	—	—	80	
	HSC12045	18	M12×1.75	57	12	10	—	—	80	WSX445 (⊕K016)
	HSC12060	18	M12×1.75	72	12	10	—	—	80	VPX200/300 (⊕K086,K100)
	HSC12070	18	M12×1.75	82	12	10	—	—	80	APX3000/4000 (⊕K133,K140) AJX (⊕K180) WSX445 (⊕K016)
	HSC16040	24	M16×2	56	16	14	—	—	150	WSX445 (⊕K016)
	* HSC16040H	24	M16×2	56	16	14	—	—	150	APX3000/4000 (⊕K133,K140) AJX (⊕K180)
HSC16055	24	M16×2	71	16	14	—	—	150	VPX200/300 (⊕K086,K100)	
HSC16065	24	M16×2	81	16	14	—	—	150	VPX200/300 (⊕K086,K100)	
HSC16080	24	M16×2	96	16	14	—	—	150		
HSC20040	30	M20×2.5	60	20	17	—	—	320		
HSC20090	30	M20×2.5	110	20	17	—	—	320		
	HSCX12030H	24	M12×1.75	37	7	8	—	—	40	FMAX (⊕K051)
	HSCX16035H	30	M16×2	44	9	12	—	—	100	
	HSCX20035H	36	M20×2.5	46	11	14	—	—	180	
	HFF08033H	11	M8×1.25	33	5	5	90°	—	8.2	WJX09 (⊕K072)
	HFF08043H	11	M8×1.25	43	5	5	90°	—	8.2	AXD4000 (⊕K155)
	MBA16033H	40	M16×2	43	10	14	—	—	150	AHX640 (pour ⌀100) (⊕K041) WSX445 (⊕K016)
	MBA20040H	50	M20×2.5	54	14	17	—	—	320	APX4000 (⊕K140) AHX475S (⊕K038) AHX640S (⊕K041) AXD4000 (⊕K155) AXD7000 (⊕K166) AJX (⊕K180)

* Avec trou de lubrification.

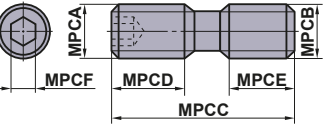
Géométrie	Référence	Dimensions (mm)						TQ (N·m)	Porte-outil
		MPCA	MPCB	MPCC	MPCD	MPCE	MPCF		
	HDS08030	M8×0.75	M8×1.25	30	13.5	11.5	4	8.2	BRP (⊕K190)
	HDS10031	M10×1.0	M10×1.5	31	14	12	5	9.0	PMF (⊕K234)

N

PIÈCES DÉTACHÉES

PIÈCES DÉTACHÉES

VIS DE RÉGLAGE GROSSIER

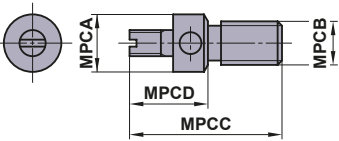
Géométrie	Référence	Dimensions (mm)					Angle	MPCDS	TQ (N·m)	Porte-outil
		MPCA	MPCB	MPCC	MPCD	MPCE	B1			
	KSS2	6.6	M5×0.8	17.5	9	—	—	—	FMAX (⊕K051)	

N

PIÈCES DÉTACHÉES

ÉCROU DE RÉGLAGE MICROMÉTRIQUE

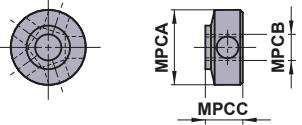
Géométrie	Référence	Dimensions (mm)					Angle	MPCDS	TQ (N·m)	Porte-outil
		MPCA	MPCB	MPCC	MPCD	MPCE	B1			
	KSN3	8.6	M3×0.35	4.3	—	—	—	—	FMAX (⊕K051)	

ASSISE

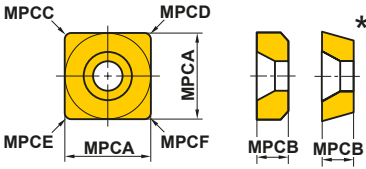
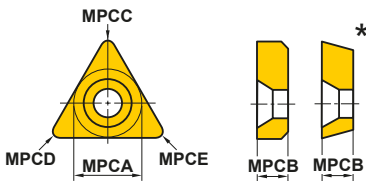
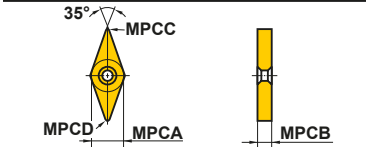
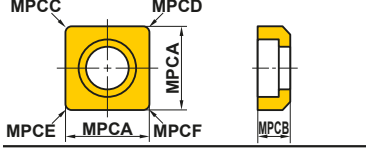
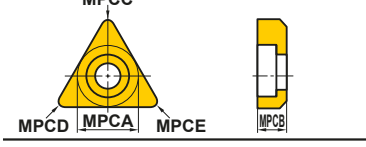
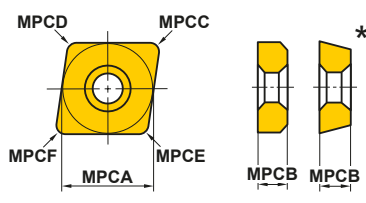
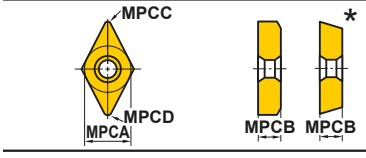
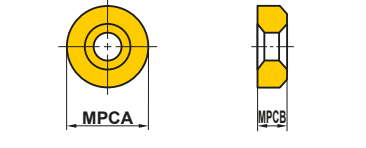
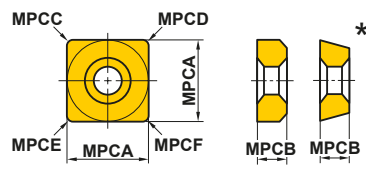
Géométrie	Référence	Dimensions (mm)						Porte-outil
		MPCA	MPCB	MPCC	MPCD	MPCE	MPCF	
	CS32	9.52	3.18	0.8	0.8	1.2	1.2	
	CS42	12.70	3.18	0.8	0.8	1.2	1.6	
	CS43	12.70	4.76	0.8	0.8	1.2	1.6	
	* PS31	8.28	2.38	0.2	0.2	0.6	0.6	
	* PS42	11.46	3.18	0.2	0.2	0.6	1.0	
	CT22	6.35	3.18	0.4	0.8	1.2	—	
	CT32	9.52	3.18	0.4	0.8	1.2	—	
	* PT21	5.11	2.38	0.2	0.2	0.6	—	
	* PT32	8.28	3.18	0.2	0.2	0.6	—	Barre d'alésage F (⊕E028)
	* PT42	10.85	3.18	0.3	0.3	0.7	—	
BPT322	7.8	3.18	—	—	—	—		
	DCSVN32	9.52	3.18	0.8	1.2	—	—	Porte-outil DOUBLE-FORCE (⊕C019) BARRE D'ALÉSAGE DIMPLE BAR (⊕E017)
	ESS42	12.70	3.18	0.8	0.8	1.2	1.6	
	EST32	9.52	3.18	0.4	0.8	1.2	—	
	EST43	12.70	4.76	0.4	0.8	1.2	—	
	LLSCN3T3	9.52	3.97	0.4	0.4	0.8	0.8	Porte-outil type LL (⊕C008)
	LLSCN33	9.52	4.76	0.4	0.4	0.8	0.8	Porte-outil type LL (⊕C008)
	LLSCN42	12.70	3.18	0.8	0.8	1.2	1.2	BARRE D'ALÉSAGE DIMPLE BAR (⊕E015)
	LLSCN53	15.87	4.76	1.2	1.2	1.6	1.6	Barre d'alésage P (⊕E038)
	LLSCN63	19.05	4.76	1.2	1.2	1.6	1.6	Porte-outil HSK (⊕H001)
	* LLSCP42	12.70	3.18	0.8	0.8	1.2	1.2	BARRE D'ALÉSAGE DIMPLE BAR (⊕E015)
	* LLSDP63	19.05	4.76	1.2	1.2	1.6	1.6	Barre d'alésage P (⊕E038)
	LLSDN32	9.52	3.18	0.8	1.2	—	—	Porte-outil DOUBLE-FORCE (⊕C010)
	LLSDN42	12.70	3.18	0.8	1.2	—	—	Porte-outil type LL (⊕C010)
	LLSDN43	12.70	4.76	0.8	1.2	—	—	BARRE D'ALÉSAGE DIMPLE BAR (⊕E015)
	LLSDN53	15.87	4.76	1.2	1.6	—	—	Barre d'alésage P (⊕E038)
* LLSDP42	12.70	3.18	0.8	1.2	—	—	Porte-outil HSK (⊕H001)	
	* LLSDP42	12.70	3.18	0.8	1.2	—	—	BARRE D'ALÉSAGE DIMPLE BAR (⊕E015)
	LLSRN103	8.3	3.18	—	—	—	—	Porte-outil type LL (⊕C026)
	LLSRN123	9.8	3.18	—	—	—	—	Porte-outil HSK (⊕H001)
	LLSRN164	13.6	4.76	—	—	—	—	
	LLSRN204	17.3	4.76	—	—	—	—	
	LLSRN256	22.0	6.35	—	—	—	—	
	LLSRN326	28.0	6.35	—	—	—	—	
	LLSSN32	9.52	3.18	0.8	0.8	1.2	1.2	
	LLSSN33	9.52	4.76	0.8	0.8	1.2	1.2	BARRE D'ALÉSAGE DIMPLE BAR (⊕E016)
	LLSSN42	12.70	3.18	0.8	0.8	1.2	1.6	Barre d'alésage P (⊕E037)
	LLSSN53	15.87	4.76	1.2	1.2	1.6	1.6	
	LLSSN63	19.05	4.76	1.2	1.2	1.6	2.0	
	LLSSN84	25.40	6.35	1.6	1.6	2.4	2.4	
* LLSSP42	12.70	3.18	0.8	0.8	1.2	1.6	BARRE D'ALÉSAGE DIMPLE BAR (⊕E016)	

PIÈCES DÉTACHÉES

ASSISE

PIÈCES DÉTACHÉES

N

Géométrie	Référence	Dimensions (mm)						Porte-outil
		MPCA	MPCB	MPCD	MPCE	MPCF		
	LLSTE32	7.6	3.18	0.4	0.4	0.4	—	Porte-outil type LL (☉C016) BARRE D'ALÉSAGE DIMPLE BAR (☉E016) Barre d'alésage P (☉E037)
	LLSTN32	9.52	3.18	0.4	0.8	1.2	—	
	LLSTN33	9.52	4.76	0.4	0.8	1.2	—	
	LLSTN42	12.70	3.18	0.4	0.8	1.2	—	
	LLSTN53	15.87	4.76	0.8	1.2	1.6	—	
	* LLSTP32	9.52	3.18	0.4	0.8	1.2	—	
* LLSTP42	12.70	3.18	0.4	0.8	1.2	—		
	LLSWN32	9.52	3.18	0.4	0.8	1.2	—	Porte-outil type LL (☉C022) Porte-outil DOUBLE-FORCE (☉C022) BARRE D'ALÉSAGE DIMPLE BAR (☉E017)
	LLSWN3T3	9.52	3.97	0.4	0.8	1.2	—	
	LLSWN42	12.70	3.18	0.4	0.8	1.2	—	
	* LLSWP32	9.52	3.18	0.4	0.8	1.2	—	
	* LLSWP42	12.70	3.18	0.4	0.8	1.2	—	
	MHS532R/L	9.4	15.7	4.5	0.8	0.8	—	
	MHS533R/L	9.4	15.7	4.5	1.2	1.2	—	
	MHS534R/L	9.4	15.7	4.5	1.6	1.6	—	
	MHS543R/L	9.4	15.7	6.5	1.2	1.2	—	
	MLCP42	12.58	3.18	1.2	1.2	1.2	1.2	Barre d'alésage P (☉E038)
	MLDP42	12.56	3.18	1.2	1.2	—	—	Barre d'alésage P (☉E038)
	MLSP42	12.63	3.18	1.2	1.2	1.2	1.2	Barre d'alésage P (☉E037)
	MLTP32	9.50	3.18	1.2	1.2	1.2	—	Barre d'alésage P (☉E037)
	MSCN63	18.8	4.76	1.6	1.6	1.6	1.6	Porte-outil DOUBLE-FORCE (☉C009) (pour coupe difficile)
	MSSN63	18.8	4.76	1.6	1.6	1.6	1.6	Porte-outil DOUBLE-FORCE (☉C012) (pour coupe difficile)
	CT32T1	9.525	15.03	3.18	—	—	—	
	* PT32T1R	8.28	13.34	3.18	—	—	—	
	* PT32T2R	8.28	13.19	3.18	—	—	—	

Géométrie	Référence	Dimensions (mm)						Porte-outil
		MPCA	MPCB	MPCC	MPCD	MPCE	MPCF	
	PV321	9.52	3.18	0.4	0.4	—	—	Porte-outil type MP (C019)
	PV322	9.52	3.18	0.8	0.8	—	—	
	PV323	9.52	3.18	1.2	1.2	—	—	
	SPSVN32	8.06	3.18	0.3	0.3	—	—	Porte-outil type SP (C030) Porte-outil HSK (H001)
	STASX400N	11.00	3.00	0.4	0.4	0.4	0.4	ASX400 (K068)
	STASX445N	10.76	3.00	—	—	—	—	ASX445 (K026)
	STBS500N	12.7	3.18	0.8	0.8	0.8	0.8	
	WPSTN33	9.3	4.76	0.8	0.4	1.2	—	Porte-outil type WP (C017)
	WPSTN43	12.50	4.76	0.8	0.4	1.2	—	
	* WPSWC43	12.50	4.76	0.4	0.8	1.2	—	Porte-outil type WP (C023)
	WPSWN43	12.50	4.76	0.4	0.8	1.2	—	
	SPSDN32	8.687	3.175	—	—	—	—	

PIÈCES DÉTACHÉES

GOUPILLE / LEVIER

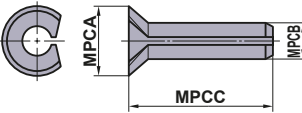
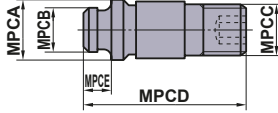
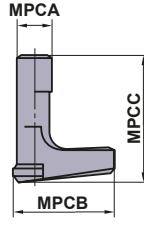
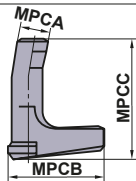
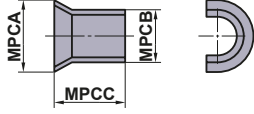
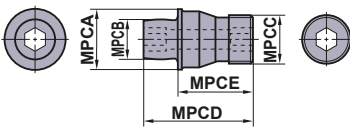
Géométrie	Référence	Dimensions (mm)					Porte-outil
		MPCA	MPCB	MPCC	MPCD	MPCE	
	BCP141	3.0	1.4	5.6	—	—	Porte-outil type SP (⊕C030) Barre d'alésage F (⊕E028) Porte-outil HSK (⊕H013)
	BCP201	4.3	2	7.4	—	—	
	BCP202	4.3	2	6.4	—	—	
	BCP251	4.8	2.5	7.4	—	—	
	BCP252	4.8	2.5	6.4	—	—	
	BCP301	5.3	3	7.4	—	—	
	CCP33	6.5	3.66	M5×0.8	18.5	3	Porte-outil WP (⊕C017)
	CCP34	7.5	5.0	M6×1.0	18.5	3	
	CCP44	7.5	5.0	M5×0.8	14.2	3	
	LLCL12S	2.1	9.3	5.6	—	—	Porte-outil type LL (⊕C016) Barre d'alésage P (⊕E037) Porte-outil HSK (⊕H001)
	LLCL13	3.6	10	12.5	—	—	
	LLCL13S	3.6	10	7.8	—	—	
	LLCL14	4.7	13.4	13.2	—	—	
	LLCL14S	4.7	13.6	12.2	—	—	
	LLCL15	6.0	19	17	—	—	
	LLCL16	7.5	20.8	21	—	—	
	LLCL18	8.6	25.4	25.2	—	—	
	LLCL23	3.6	12.0	11.5	—	—	
	LLCL23S	3.6	11.6	9.5	—	—	
	LLCL24	4.7	16.2	14.8	—	—	
	LLCL25	6.0	17.1	17	—	—	
	LLCL110	3.0	10.7	11.6	—	—	Porte-outil type LL (⊕C008)
	LLCL112	3.5	13	13.5	—	—	
	LLCL116	4.5	18.5	18	—	—	
	LLCL120	5.6	20.3	19	—	—	
	LLCL125	6	24	24	—	—	
	LLCL132	8	30	27	—	—	
	LLP13	5.55	4.85	5.3	—	—	Porte-outil DOUBLE-FORCE (⊕C008) BARRE D'ALÉSAGE DIMPLE BAR (⊕E015) Barre d'alésage P (⊕E037) Porte-outil HSK (⊕H001)
	LLP14	7.25	6.55	5.8	—	—	
	LLP15	8.8	8.05	8.6	—	—	
	LLP16	10.85	9.85	11.1	—	—	
	LLP18	15.35	13.05	12.0	—	—	
	LLP23	5.55	4.85	6.8	—	—	
	LLP24	7.25	6.55	9.1	—	—	
	MP6	11.9	7.8	M10×1	22.1	15	Porte-outil DOUBLE-FORCE (⊕C009) (pour coupe difficile)

PIÈCES DÉTACHÉES

N

GOUPILLE DE FIXATION

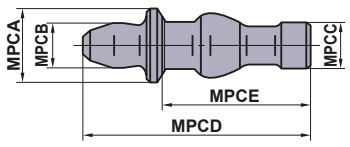
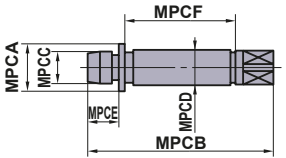
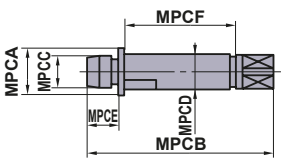
Géométrie	Référence	Dimensions (mm)						Porte-outil
		MPCA	MPCB	MPCC	MPCD	MPCE	MPCF	
	P11S	6	3.7	4	17	11.1	—	Porte-outil type MP (☉C019)
	P21S	7.5	4.9	4.5	17.2	11.5	—	
	P221US	4	18	2.11	3.5	3.3	7.7	
	P333WS	5.75	24	3.64	5.0	4.9	11.3	
	P434W	7.75	30	5.03	7.0	4.9	16.8	

BRIDE DE SERRAGE

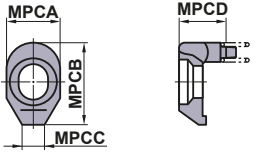
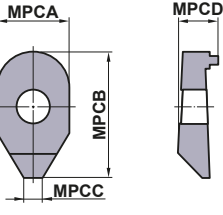
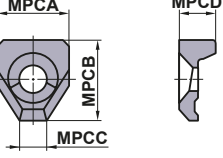
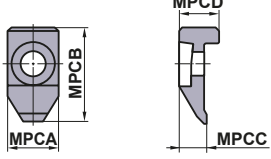
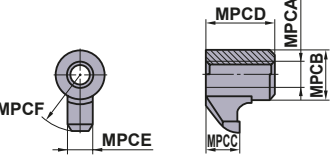
Géométrie	Référence	Dimensions (mm)						Porte-outil
		MPCA	MPCB	MPCC	MPCD	MPCE	MPCF	
	AMS3	7	12	3	3.3	—	—	Porte-outil Profil (☉C032) AJX (☉K180)
	AMS4	9	13.5	3	3.8	—	—	
	AMS5	10	15	3.5	5	—	—	
	CA142	8	15	4	7	—	—	
	CA150	9	16	4.5	7	—	—	
	CA151	10	17	5	7	—	—	
	CA152	10	19	5	7	—	—	
	CA153	10	24	5	7	—	—	
	CA161	13	20	6	8	—	—	
	CA162	13	24	6	8	—	—	
	CA163	13	27	6	8	—	—	
	CA181	16	30	8	10	—	—	
CA183	16	37	8	10	—	—		
	CCK13	15	18.5	6	9	—	—	Porte-outil type WP (☉C017)
	CCK14	19	22	8	9.5	—	—	
	CCTC1	13	25	7	10.2	—	—	
	CK231	M6×1	8	4	7.5	4.5	9.5	
	CK232	M6×1	8	4.5	8	4.5	11.5	
	CK341	M8×1	11	5.5	13.5	6	13.5	
	CK342	M8×1	11	6	14	6	16.5	

N

PIÈCES DÉTACHÉES

PIÈCES DÉTACHÉES

BRIDE DE SERRAGE

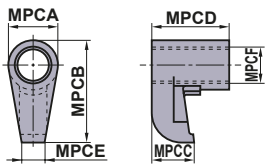
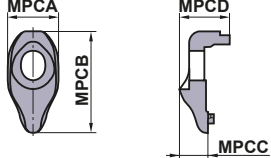
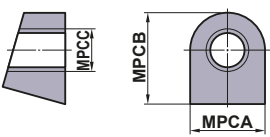
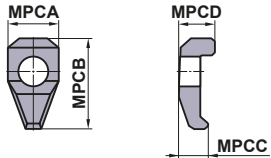
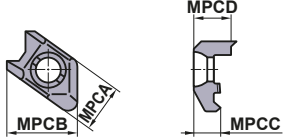
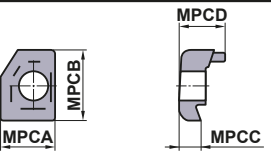
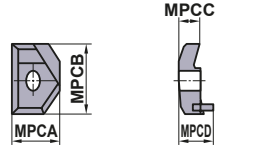
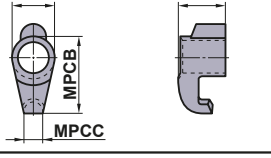
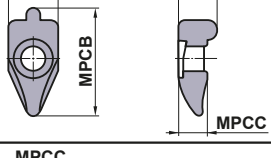
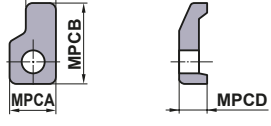
Géométrie	Référence	Dimensions (mm)						Porte-outil
		MPCA	MPCB	MPCC	MPCD	MPCE	MPCF	
	CKW6	10.9	22.5	9.2	16.8	5	M8×1	Porte-outil DOUBLE-FORCE (⊕C009) (pour coupe difficile)
	DCK2211 DCK2613 DCK3113	11 13 13	22 26.5 31	6.57 7.35 9	11.1 12.9 14.5	— — —	— — —	Porte-outil DOUBLE-FORCE (⊕C008) BARRE D'ALÉSAGE DIMPLE BAR (⊕E015) Porte-outil HSK (⊕H001)
	KGC1	12.0	15.0	M7×0.75	—	—	—	
	LK1	8	14.3	4.5	5.9	—	—	
	MHK5NR/L	15.5	23.5	8.1	12.1	—	—	
	MTK1R/L	13	17.5	5	12	—	—	Porte-outil type MG (⊕F124) Porte-outil type MT (⊕G024) Porte-outil HSK (⊕H001)
	MTK2R/L	18	28	7	14	—	—	
	SETK51 SETK61	6.8 8.9	14.5 18.1	2.9 4.1	8 8.6	— —	— —	Porte-outil type MMTE (⊕G019) Porte-outil type MMTI (⊕G026) Porte-outil HSK (⊕H001)
	SRK1R	9.4	21	5.5	7.5	—	—	
	UCR	12	24	8	7	—	—	

N
PIÈCES DÉTACHÉES

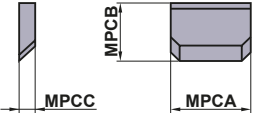
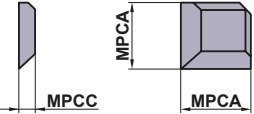
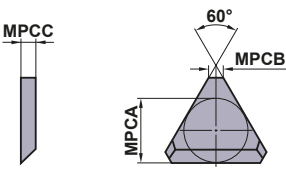

BRISE-COPEAUX

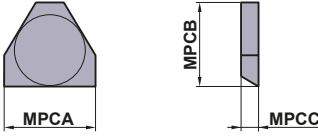
Géométrie	Référence	Dimensions (mm)					Porte-outil
		MPCA	MPCB	MPCC	IC	LBB	
	CBS3	9.4	8.0	1.5	9.525	1.5	
	CBS4	12.6	9.2	2.5	12.70	3.5	
	CBS4N	12.6	10.2	2.5	12.70	2.5	
	CBS4F	12.6	11.2	2.5	12.70	1.5	
	CBS6	18.9	14.6	2.5	19.05	4.5	
	CBS6F	18.9	17.6	2.5	19.05	1.5	
	CBS3D	8.0	—	1.5	9.525	1.5	
	CBS4D	10.2	—	2.5	12.70	2.5	
	CBT2N	5.67	1.4	1.5	6.35	1.0	Barre d'alésage F (⊕E028) *Pour les plaquettes positives, la largeur du brise-copeaux est 0.5mm plus grande que ce qui est représenté dans la liste.
	CBT3	7.20	1.4	2.5	9.525	3.5	
	CBT3N	7.87	1.4	2.5	9.525	2.5	
	CBT3F	8.53	1.4	2.5	9.525	1.5	
	CBT4N	11.07	1.4	2.5	12.70	2.5	
	CBT4F	11.73	1.4	2.5	12.70	1.5	

Géométrie	Référence	Dimensions (mm)			MPCD (mm)	Porte-outil
		MPCA	MPCB	MPCC		
	CBT3106	11.5	10.6	2.0	2.5—3.0	
	CBT3113	11.5	11.3	2.0	1.5—2.0	
	CBT3120	11.5	12	2.0	0.75—1.25	

ANTI-GRIPPANT

ANTI-GRIPPANT

Forme	Référence	Stock	Volume (g)
	MK1K	★	20
	MK1KS	★	3

N

PIÈCES DÉTACHÉES

★ : Article standard Japon.

DONNÉES TECHNIQUES

CONFORMITÉ ISO13399	P002
SURFAÇAGE - PROBLÈMES/SOLUTIONS	P006
GÉOMÉTRIE DES OUTILS (FRAISAGE)	P007
FORMULES DE SURFAÇAGE	P010
FRAISAGE DEUX TAILLES - PROBLÈMES/SOLUTIONS	P012
TABLEAU DE COMPARAISON DES MATIÈRES	P014
ÉTAT DE SURFACE	P018
CORRESPONDANCE DURETÉ	P019
TABLE DE TOLÉRANCES DES TROUS	P020
TABLEAU DE TOLÉRANCES DES ARBRES	P022
SYSTÈME INTERNATIONAL	P024
TYPE D'USURE	P025
MATÉRIAUX DE COUPE	P026
CLASSIFICATION DES NUANCES	P027
TABLEAU DE COMPARAISON DES NUANCES	P028



CONFORMITÉ ISO13399

Liste de symboles normalisés ISO 13399

Alphabétique

Source : norme ISO 13399

URL : <https://www.iso.org/search/x/query/13399>

ISO13399 Symbole	Contenu
ADJLX	Limite de réglage maximum
ADJRG	Plage de réglage
ALF	Angle de dépouille radial
ALP	Angle de dépouille axial
AN	Angle de dépouille principal
ANN	Angle de dépouille secondaire
APMX	Profondeur de coupe maximale
AS	Angle de dépouille de l'arête de planage
ASP	Vis de réglage
AZ	Profondeur de plongée maximale
B	Largeur de queue
BBD	Équilibré par conception
BCH	Longueur du chanfrein d'angle
BD	Diamètre de corps
BDX	Diamètre de corps maximale
BHCC	Nombre de cercles d'avant-trous
BHTA	Angle semi-conique du corps
BMC	Code de la matière du corps
BS	Longueur de l'arête de planage
BSR	Rayon de l'arête de planage
CASC	Code de taille du la cartouche
CB	Nombre de faces du brise-copeaux
CBDP	Profondeur d'alésage
CBMD	Désignation du fabricant du brise-copeaux
CBP	Propriété du brise-copeaux
CCMS	Code de connexion côté machine
CCWS	Code de connexion côté pièce à usiner
CCP	Propriété du chanfrein d'angle
CDI	Diamètre de coupe de la plaquette
CDX	Profondeur de coupe maximum
CEATC	Code de type de l'angle de l'arête de coupe de l'outil
CECC	Code de l'état de l'arête de coupe
CEDC	Nombre d'arêtes de coupe
CF	Chanfrein de point
CHW	Largeur du chanfrein de la pointe
CICT	Nombre d'éléments de coupe
CNC	Nombre d'angles
CND	Diamètre de l'entrée du liquide de coupe
CNSC	Code du type d'entrée du liquide de coupe
CNT	Taille du filetage de l'orifice d'adduction de liquide de coupe
CP	Pression du liquide de coupe
CRE	Rayon de point
CRKS	Dimension du filetage de fixation
CSP	Propriété du liquide de coupe
CTP	Propriété du revêtement
CTX	Translation horizontale du point de coupe
CTY	Translation verticale du point de coupe
CUTDIA	Diamètre de tronçonnage maximal de la pièce
CUB	Base de l'unité de connexion
CW	Largeur de coupe
CWX	Largeur de coupe maximum
CXD	Diamètre de la sortie du liquide de coupe

P

DONNÉES TECHNIQUES

ISO13399 Symbole	Contenu
CXSC	Code de type de sortie de liquide de coupe
CZC	Code de dimension de connexion
D1	Diamètre du trou de fixation
DAH	Diamètre du trou d'accès
DAXN	Diamètre extérieur minimum de la gorge axiale
DAXX	Diamètre extérieur maximum de la gorge axiale
DBC	Diamètre du cercle de vissage
DC	Diamètre de coupe
DCB	Diamètre d'alésage du raccord
DCBN	Diamètre d'alésage du raccord minimum
DCBX	Diamètre d'alésage du raccord maximum
DCC	Code de style de la configuration conceptuelle
DCCB	Diamètre nominal d'alésage de la connexion
DCIN	Diamètre de coupe interne
DCINN	Diamètre de coupe interne minimum
DCINX	Diamètre de coupe interne maximum
DCN	Diamètre de coupe min.
DCON	Diamètre de raccordement
DCONMS	Diamètre de connexion côté machine
DCONWS	Diamètre de connexion côté pièce à usiner
DCSC	Code de taille du diamètre de coupe
DCSFMS	Diamètre de la surface de contact côté machine
DCX	Diamètre de coupe maximale
DF	Diamètre de flasque
DHUB	Diamètre du moyeu
DMIN	Diamètre d'alésage minimal
DMM	Diamètre de la queue
DN	Diamètre de collet
DRVA	Angle de travail
EPSR	Angle inclus de la plaquette
FHA	Angle d'hélice de goujure
FHCSA	Angle de lamage du trou de fixation
FHCSD	Diamètre nominal du trou de fixation
FLGT	Épaisseur de bride
FMT	Type de forme
FXHLP	Propriété du trou de fixation
GAMF	Angle de coupe radial
GAMN	Angle de coupe normal
GAMO	Angle de dépouille orthogonal
GAMP	Angle de dépouille axial
GAN	Angle d'attaque
H	Hauteur de queue
HA	Hauteur de filet théorique
HAND	Sens
HBH	Hauteur de la tête
HBKL	Longueur excentrée du dos de la tête
HBKW	Largeur de la tête
HBL	Longueur excentrée du bas de la tête
HC	Hauteur de filet réelle
HF	Hauteur fonctionnelle
HHUB	Hauteur du moyeu
HTB	Hauteur de corps
IC	Diamètre du cercle inscrit
IFS	Code de style du montage de la plaquette
IIC	Code d'interface de la plaquette
INSL	Longueur de la plaquette
KAPR	Angle de coupe
KCH	Chanfrein d'angle

DONNÉES TECHNIQUES

ISO13399 Symbole	Contenu
KRINS	Angle de l'arête principale
KWW	Largeur de clavette
KYP	Propriété de la clavette
L	Longueur taillée
LAMS	Inclinaison de l'angle
LB	Longueur de corps
LBB	Largeur du brise-copeaux
LBX	Longueur maximum de corps
LCCB	Profondeur nominale d'alésage de la connexion
LCF	Longueur de goujure
LDRED	Longueur réduite du diamètre du corps
LE	Longueur effective de l'arête de coupe
LF	Longueur fonctionnelle
LFA	une dimension sur lf
LH	Longueur de tête
LPR	Porte-à-faux
LS	Longueur de queue
LSC	Longueur de serrage
LSCN	Longueur de serrage minimum
LSCX	Longueur de serrage maximale
LTA	Longueur LTA (longueur de MCS à CRP)
LU	Longueur utile
LUX	Longueur utile maximale
M	Dimension m
M2	Distance entre le cercle inscrit nominal et le bec d'une plaquette à angle complémentaire
MHA	Angle du trou de fixation
MHD	Distance du trou de fixation
MHH	Hauteur du trou de fixation
MIID	Identification de la plaquette modèle
MTP	Code de type de serrage
NCE	Nombre d'extrémités tranchantes
NOF	Nombre de goujures
NOI	Nombre d'index de plaquette
NT	Nombre de dents
OAH	Hauteur totale
OAL	Longueur totale
OAW	Largeur totale
PDPT	Profondeur de profil de la plaquette
PDX	Distance du profil ex
PDY	Distance du profil ey
PFS	Code de style du profil
PL	Longueur de pointe
PNA	Profil d'angle
PRFRAD	Rayon de profil
PSIR	Angle d'attaque de l'outil
PSIRL	Angle de coupe, outil à gauche
PSIRR	Angle de coupe, outil à droite
RAL	Angle de dépouille, outil à gauche
RAR	Angle de dépouille, outil à droite
RCP	Propriété de l'angle arrondi
RE	Rayon de pointe
REL	Rayon de pointe gauche
RER	Rayon de pointe droite
RMPX	Angle de rampe maximale
RPMX	Vitesse rotative maximale
S	Épaisseur plaquette
S1	Épaisseur de plaquette
SC	Épaisseur de plaquette totale
SDL	Longueur d'épaulement
SIG	Angle de pointe

ISO13399 Symbole	Contenu
SSC	Code de taille de plaquette
SX	Code de forme de la coupe transversale de queue
TC	Classe de tolérance de la plaquette
TCE	Code de l'arête de coupe munie d'une plaquette
TCTR	Classe de tolérance du filet
TD	Diamètre du filet
THFT	Type de forme
THL	Longueur du filetage
THLGTH	Longueur du filet
THSC	Code de forme du porte-outil
THUB	Épaisseur du moyeu
TP	Pas filetage
TPI	Filets par pouce
TPIN	Filets par pouce, minimum
TPIX	Filets par pouce, maximum
TPN	Pas filetage minimum
TPT	Type de profil du filet
TPX	Pas filetage maximale
TQ	Couple
TSYC	Code du type d'outil
TTP	Type filetage
ULDR	Rapport longueur utile diamètre
UST	Système d'unités
W1	Largeur de la plaquette
WEP	Propriété de l'arête de planage
WF	Largeur fonctionnelle
WF2	Distance entre le point de référence et l'appui frontal d'un outil de tournage
WFS	Largeur fonctionnelle secondaire
WT	Poids de l'article
ZEFF	Nombre d'arêtes de coupe effectives en bout
ZEFP	Nombre effectif d'arêtes
ZNC	Nombre d'arêtes de coupe au centre
ZNF	Nombre de plaquettes de face
ZNP	Nombre de plaquettes périphériques

Symboles de référence (ISO 13399)

ISO13399 Symbole	Contenu
CIP	Système de coordination en cours d'utilisation
CRP	Point de référence de coupe
CSW	Système de coordination côté pièce à usiner
MCS	Système de coordination de montage
PCS	Système de coordination primaire

SURFAÇAGE - PROBLÈMES/SOLUTIONS

DONNÉES TECHNIQUES

P

Solution		Choix de la nuance				Conditions de coupe				Géométrie outil						Machine fixation outil								
		Choisir une nuance plus dure	Choisir une nuance plus tenace	Choisir une nuance plus résistante aux chocs thermiques	Choisir une nuance plus résistante au collage	Vitesse de coupe	Avance	Profondeur de passe	Angle d'engagement	Arrosage		Angle de coupe	Angle de pointe	Chanfrein d'arête	Diamètre fraise	Nombre de dents	Espace à copeaux	Utilisation d'une plaquette réversible avec wiper	Amélioration de la tolérance de circularité	Rigidité fraise	Augmenter la rigidité du bridage de l'outil et de la pièce	Diminuer le porte-à-faux	Réduire la puissance et le jeu de la machine	
										Augmenter ↗	Diminuer ↘													Ne pas utiliser de lubrifiant soluble
Problème	Facteur																							
		Détérioration de la durée de vie de l'outil	Usure rapide des plaquettes réversibles	●										↗	↗	↘				●				
Effritement ou cassure de l'arête de coupe			●											↗										
Détérioration de l'état de surface	Mauvais état de surface	●																						
	Planéité pièce surface irrégulière																							
Bavures, écaillage de la pièce	Bavures, écaillage																							
	Ébrèchement pièce																							
Contrôle copeaux	Mauvaise formation copeaux, enchevêtrement																							

GÉOMÉTRIE DES OUTILS (FRAISAGE)

■ FONCTION DE CHAQUE ANGLE DE COUPE EN SURFAÇAGE

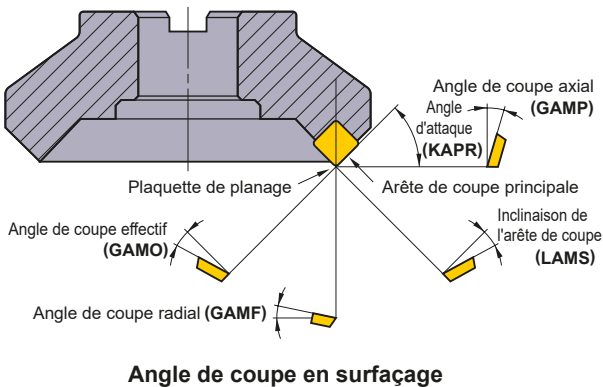

Type d'angle	Symbole	Fonction	Effet
Angle de coupe axial	GAMP	Détermine la direction des copeaux.	Positive : Excellente usinabilité.
Angle de coupe radial	GAMF	Détermine l'acuité d'arête.	Négative : Excellente évacuation des copeaux.
Angle d'attaque	KAPR	Détermine l'épaisseur des copeaux.	Petit : Copeaux fins et peu d'effet d'impact. Effort de coupe renvoyé sur le corps.
Angle de coupe effectif	GAMO	Détermine l'acuité réelle.	Positive (fortement) : Excellente usinabilité. Arête rapportée minimum. Négative (fortement) : Mauvaise usinabilité. Arête de coupe renforcée.
Inclinaison de l'arête de coupe	LAMS	Détermine la direction des copeaux.	Positive (fortement) : Excellente évacuation des copeaux. Faible effort de coupe.

Angle de coupe en surfacage

■ PLAQUETTES STANDARDS

● Angle de coupe positif ou négatif

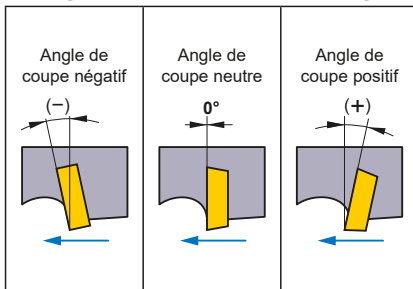

- Pointe de l'arête de coupe en avant = angle de coupe positif.
- Pointe de l'arête de coupe en arrière = angle de coupe négatif.

● Formes standards des plaquettes

Combinaisons standard des arêtes de coupe	(+) Angle de coupe axial	(-) Angle de coupe axial	(+) Angle de coupe axial
	Angle de coupe radial (+)	Angle de coupe radial (-)	Angle de coupe radial (-)
	Double positive (DP arête de coupe)	Double négative (DN arête de coupe)	Négative/Positive (NP arête de coupe)
Angle de coupe axial (GAMP)	Positive (+)	Négative (-)	Positive (+)
Angle de coupe radial (GAMF)	Positive (+)	Négative (-)	Négative (-)
Géométrie utilisée	Plaquette positive (non réversible)	Plaquette négative (réversible)	Plaquette positive (non réversible)
Matière	Acier	-	●
	Fonte grise	-	●
	Alliage aluminium	-	-
	Inox, réfractaires	●	-

■ ANGLE D'ATTAQUE (KAPR) ET CARACTÉRISTIQUES DE COUPE

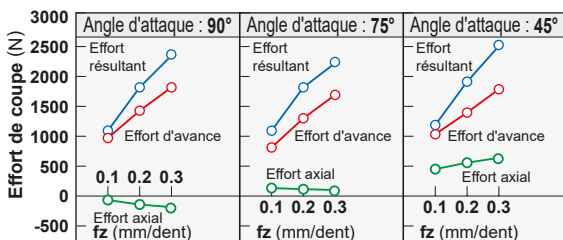

Matière : DIN 41CrMo4 (281HB)

Outil : $\phi 125\text{mm}$ Plaquette unique

Conditions de coupe : $V_c=125.6\text{m/min}$ $a_p=4\text{mm}$ $a_e=110\text{mm}$

Comparaison des efforts de coupe Avec différentes formes de plaquettes

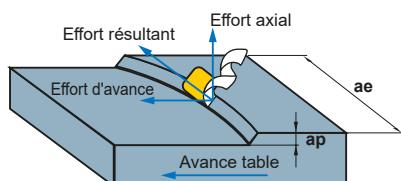

Trois efforts de coupe en présence en fraisage

Angle d'attaque 90°

Effort de coupe axial minimum. Soulève la pièce lorsque la rigidité de serrage est faible.

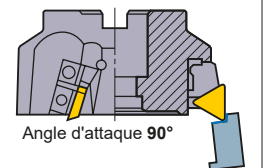

Angle d'attaque 75°

Un angle d'attaque de 75° est recommandé pour le surfacage des pièces de faible rigidité, toiles minces, protection des bords de pièces, fontes.

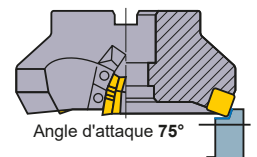

Angle d'attaque 45°

Effort de coupe axial maximum. Effort de coupe axial important. *Évite l'ébrèchement des bords de pièce fonte.

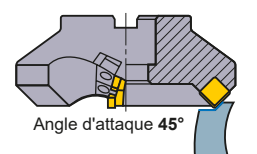

- * Effort de coupe résultant : L'effort est opposé à la rotation de la fraise.
- * Effort axial : Effort lié à la profondeur de passe.
- * Effort d'avance : Effort résultant de l'avance table.

GÉOMÉTRIE DES OUTILS (FRAISAGE)

■ ANGLE D'ATTAQUE ET DURÉE DE VIE DE L'OUTIL

● Angle d'attaque et épaisseur du copeau

Lorsque la profondeur de coupe et l'avance par dent f_z sont définies, la règle est la suivante : plus l'angle d'inclinaison (KAPR) est faible, plus l'épaisseur du copeau (h) est fine (pour un KAPR de 45°, elle est environ de 75 % de l'épaisseur avec KAPR de 90°). Si le KAPR est supérieur, la résistance de coupe augmente, ce qui conduit à une plus longue durée de vie de l'outil. En cas d'épaisseur de copeau trop importante, l'augmentation des efforts de coupe peut entraîner des vibrations et des écaillages d'arête.

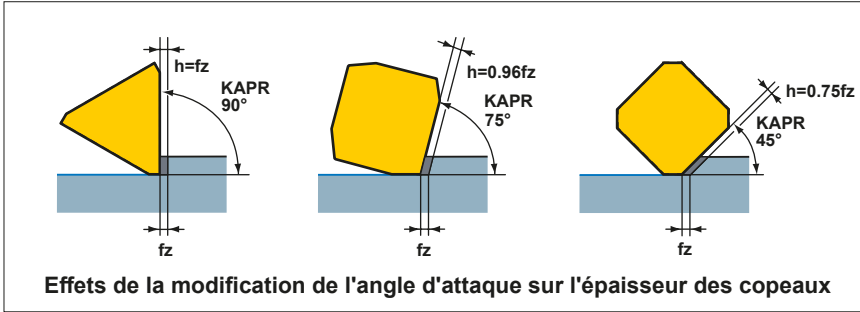

P

DONNÉES TECHNIQUES

● Angle d'attaque et usure en cratère

Le tableau suivant contient le modèle d'usure de différents angles d'inclinaison. Lorsqu'on compare l'usure en cratère pour des angles d'inclinaison de 90° et 45°, on peut nettement constater que l'usure en cratère est plus importante pour un angle d'inclinaison de 90°. Cela vient du fait qu'avec des copeaux relativement épais, la résistance de coupe augmente, ce qui favorise l'usure en cratère. Pendant la formation du cratère, la résistance de l'arête de coupe décroît. Conséquence : la rupture.

	Angle d'attaque 90°	Angle d'attaque 75°	Angle d'attaque 45°
Vc=100m/min Tc=69min			
Vc=125m/min Tc=55min			
Vc=160m/min Tc=31min			

Matière : **Acier allié (287HB)**
 Outil : **DC=125mm**
 Plaquette : **Carbure métallique M20**
 Conditions de coupe : **ap=3.0mm**
 ae=110m
 fz=0.2mm/dent
 Coupe à sec

■ FRAISAGE EN OPPOSITION ET FRAISAGE EN AVALANT

Pour le choix de la méthode d'usinage, pour le fraisage en opposition ou en avalant, la décision dépend des conditions de la machine-outil, de la fraise et de l'application. En général, on part du principe que le fraisage en avalant est plus avantageux pour la durée de vie des outils.

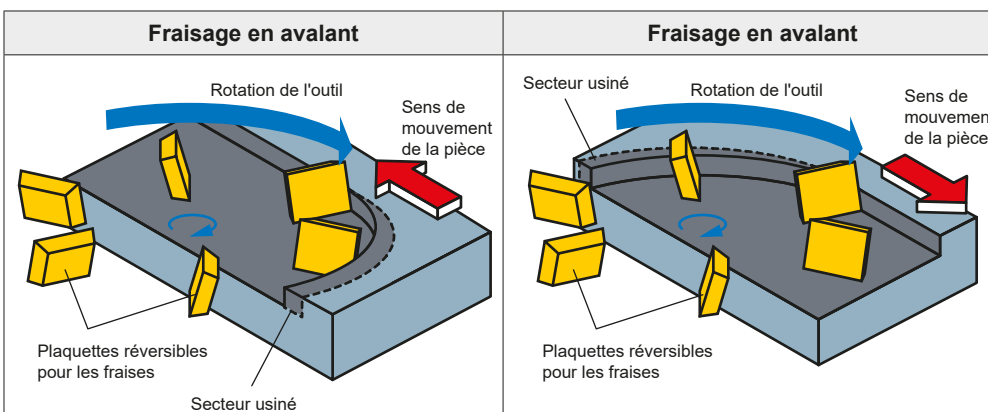

■ ÉTAT DE SURFACE

● Saut axial et radial

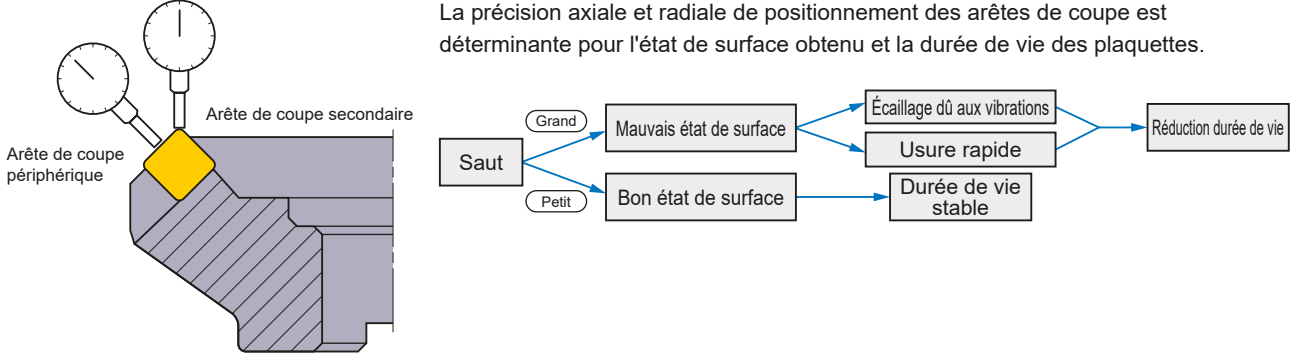

La précision axiale et radiale de positionnement des arêtes de coupe est déterminante pour l'état de surface obtenu et la durée de vie des plaquettes.

Planéité et concentricité en fraisage

● Améliore l'état de surface

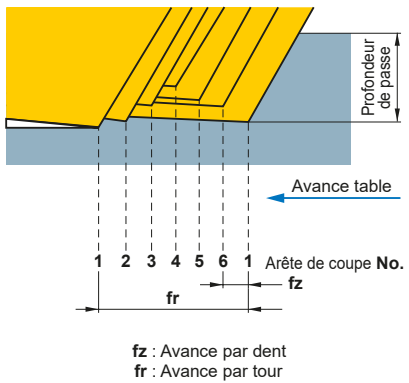

Le plat de planage standard des plaquettes de coupe Mitsubishi Carbide est de 1.4mm. Ce plat de planage est destiné à rattraper les jeux de tolérance des plaquettes indexées dans leur logement sur le corps de fraise et permettant d'obtenir un saut axial minimum, garantissant un bon état de surface, même en ébauche.

Problèmes actuels	Solution
<ul style="list-style-type: none"> · Saut axial et radial. · Inclinaison de l'arête de coupe principale. · Précision du corps de fraise. · Précision des pièces détachées. · Vibrations 	<p>Plaquette de planage</p> <ul style="list-style-type: none"> * Légèrement en avant des plaquettes standards, la plaquette de planage égalise les aspérités et permet d'obtenir un meilleur état de surface.

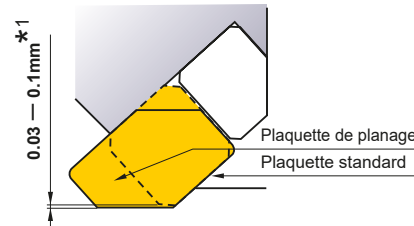

Plat de planage et état de surface

- Remplacez une ou deux plaquettes standards par une ou deux plaquettes de planage.
- Les plaquettes de planage sont indexées et dépassent les plaquettes standards de 0.03—0.1mm.

*1. La valeur dépend de l'arête de coupe et de la combinaison de plaquettes.

● Comment monter une plaquette de planage

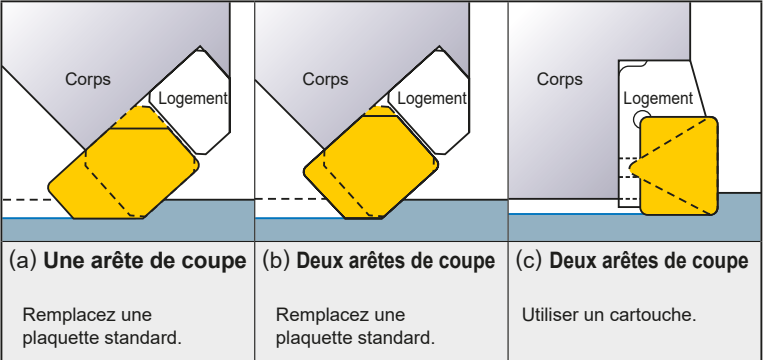

- Le plat de la plaquette de planage doit être supérieur à l'avance par tour de fraise.
- * Une arête de planage trop grande provoque des vibrations.
- Lorsque le diamètre de la fraise est important et que l'avance par tour est élevée, utilisez deux ou trois plaquettes de planage.
- Lorsque vous utilisez plus d'une plaquette Wiper, le faux-rond est éliminé.
- Utilisez une nuance ayant une haute résistance à l'usure pour les plaquettes de planage.

(a) Une arête de coupe : Remplacez une plaquette standard.

(b) Deux arêtes de coupe : Remplacez une plaquette standard.

(c) Deux arêtes de coupe : Utiliser un cartouche.

FORMULES DE SURFAÇAGE

■ VITESSE DE COUPE (Vc)

$$V_c = \frac{\pi \cdot DC \cdot n}{1000} \text{ (m/min)}$$

*Divisez par 1000 pour convertir les mm en m.

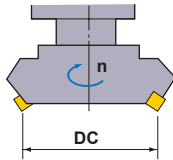

Vc (m/min) : Vitesse de coupe
 π (3.14) : Pi

DC (mm) : Diamètre de fraise
 n (t/min) : Régime

(Exemple) Trouvez la vitesse de coupe pour une fraise de ϕ 125mm avec un régime de 350t/min.

(Réponse) Substituez $\pi=3.14$, DC=125, n=350 dans la formule.

$$V_c = \frac{\pi \cdot DC \cdot n}{1000} = \frac{3.14 \times 125 \times 350}{1000} = 137.4 \text{ m/min}$$

La vitesse de coupe est de 137.4m/min

■ AVANCE PAR DENT (fz)

$$f_z = \frac{V_f}{z \cdot n} \text{ (mm/dent)}$$

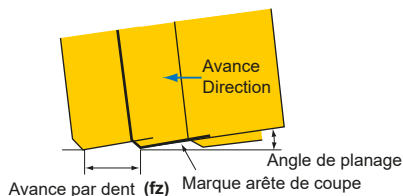

fz (mm/dent) : Avance par dent
 Vf (mm/min) : Avance par min.
 n (t/min) : Régime (Avance par tour $f = z \times fz$)

z : Référence plaquette

(Exemple) Trouvez l'avance par dent pour une fraise à 10 dents, un régime de 500t/min. et une avance minute de 500mm.

(Réponse) Appliquez la réponse ci-dessus à la formule.

$$f_z = \frac{V_f}{z \cdot n} = \frac{500}{10 \times 500} = 0.1 \text{ mm/dent}$$

La réponse est 0.1mm/dent.

■ AVANCE TABLE (Vf)

$$V_f = f_z \cdot z \cdot n \text{ (mm/min)}$$

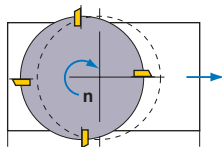

Vf (mm/min) : Avance par min.
 fz (mm/dent) : Avance par dent
 n (t/min) : Régime

z : Référence plaquette

(Exemple) Trouvez l'avance par minute pour une fraise à 10 dents, une avance par dent de 0.1mm/dent et un régime de 500 tours par minute.

(Réponse) Appliquez la réponse ci-dessus à la formule.

$$V_f = f_z \cdot z \cdot n = 0.1 \times 10 \times 500 = 500 \text{ mm/min}$$

L'avance table est de 500m/min.

■ TEMPS DE COUPE (Tc)

$$T_c = \frac{L}{V_f} \text{ (min)}$$

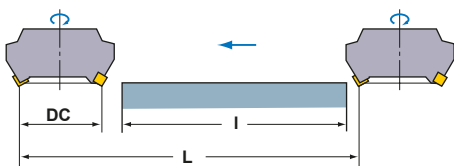

Tc (min) : Temps de coupe
 Vf (mm/min) : Avance par min.

L (mm) : Longueur usinée (Longueur de la pièce: L+Diamètre fraise : DC)

(Exemple) Trouvez le temps de coupe effectif pour usiner une pièce d'une longueur de 300mm avec une fraise de diamètre 200, 16 dents. Vitesse de coupe 125m/min, avance par dent 0.25mm/dent. (vitesse de rotation 200t/min).

(Réponse) Calculer d'abord l'avance par minute. $v_f=0.25 \times 16 \times 200=800$ mm/min
 La longueur usinée est de 300mm + dia. Fraise $L=300+200=500$ mm
 Appliquez la réponse ci-dessus à la formule.

$$T_c = \frac{500}{800} = 0.625 \text{ (min)}$$

$0.625 \times 60=37.5$ (sec). La réponse est 37.5 sec.

■ FRAISAGE (Pc)

$$P_c = \frac{a_p \cdot a_e \cdot V_f \cdot K_c}{60 \times 10^6 \times \eta}$$

P_c (kW)	: Puissance absorbée	a_p (mm)	: Profondeur de passe
a_e (mm)	: Largeur de coupe	V_f (mm/min)	: Avance table par min.
K_c (MPa)	: Effort de coupe spécifique	η	: (Régime)

(Exemple) Quelle est la puissance requise pour le fraisage d'acier à outil à une vitesse de coupe de 80m/min. Avec une profondeur de passe de 2mm, une largeur de coupe de 80mm, un déplacement de table de 280mm/min avec une fraise de $\phi 250$ avec 12 plaquettes. Coefficient rendement 80%.

(Réponse) Premièrement, calculez le nombre de tours pour obtenir l'avance par dent.

$$n = \frac{1000V_c}{\pi DC} = \frac{1000 \times 80}{3.14 \times 250} = 101.91 \text{t/min}$$

$$\text{Avance par dent } fz = \frac{V_f}{z \times n} = \frac{280}{12 \times 101.9} = 0.228 \text{mm/dent}$$

Remplacez la puissance de coupe spécifique dans la formule.

$$P_c = \frac{2 \times 80 \times 280 \times 1800}{60 \times 10^6 \times 0.8} = 1.68 \text{ kW}$$

● K_c

Matière	Résistance à la traction (MPa) et dureté	Effort de coupe spécifique K _c (MPa)				
		0.1mm/dent	0.2mm/dent	0.3mm/dent	0.4mm/dent	0.6mm/dent
Acier doux	520	2200	1950	1820	1700	1580
Acier au carbone	620	1980	1800	1730	1600	1570
Acier traité	720	2520	2200	2040	1850	1740
Acier outil	670	1980	1800	1730	1700	1600
Acier outil	770	2030	1800	1750	1700	1580
Acier chrome manganèse	770	2300	2000	1880	1750	1660
Acier chrome manganèse	630	2750	2300	2060	1800	1780
Acier chrome molybdène	730	2540	2250	2140	2000	1800
Acier chrome molybdène	600	2180	2000	1860	1800	1670
Acier nickel chrome molybdène	940	2000	1800	1680	1600	1500
Acier nickel chrome molybdène	352HB	2100	1900	1760	1700	1530
Acier inoxydable austénitique	155HB	2030	1970	1900	1770	1710
Fonte	520	2800	2500	2320	2200	2040
Fonte dure	46HRC	3000	2700	2500	2400	2200
Fonte ductile	360	2180	2000	1750	1600	1470
Fonte grise	200HB	1750	1400	1240	1050	970
Cuivre	500	1150	950	800	700	630
Alliage aluminium (Al-Mg)	160	580	480	400	350	320
Alliage aluminium (Al-Si)	200	700	600	490	450	390
Alliage aluminium (Al-Zn-Mg-Cu)	570	880	840	840	810	720

FRAISAGE DEUX TAILLES - PROBLÈMES/SOLUTIONS

DONNÉES TECHNIQUES

P

Solution		Choix de la nuance	Conditions de coupe								Géométrie outil				Machine fixation outil									
			Outil revêtu	Vitesse de coupe		Profondeur de passe	Incrément	Fraisage en avalant	Utiliser de l'air comprimé	Arrosage		Angle d'hélice	Référence plaquette	Angle de concavité de l'arête frontale	Diamètre outil	Rigidité fraise	Espace à copeaux	Réduction porté-à-faux	Augmenter la précision d'installation de l'outil	Augmenter la tolérance de circularité du porte-outil	Vérifier les pinces / échange	Vérifier rigidité et puissance machine	Augmenter la résistance de bridage de l'outil	
Augmenter ↗	Diminuer ↘	Augmenter la quantité de lubrifiant		Ne pas utiliser de lubrifiant soluble	Avec arrosage ou sans					Augmenter ↗	Diminuer ↘													Plus grand
Détérioration de la durée de vie de l'outil	Usure importante usure périphérique de l'arête de coupe	Utilisation d'une fraise non revêtue Un faible nombre d'arêtes de coupe Conditions de coupe inadaptées Utilisation du fraisage en opposition	●																					
	Importante formation de copeaux	Conditions de coupe inadaptées Arête de coupe fragile à la rupture Force de bridage insuffisante Faible résistance de bridage													●						●	●	●	●
	Rupture pendant l'usinage	Conditions de coupe inadaptées Faible rigidité de la fraise Porte-à-faux plus long que nécessaire Collage copeaux				●																		
Détérioration de l'état de surface	Vibrations pendant l'usinage	Conditions de coupe inadaptées Faible rigidité de la fraise Faible résistance de bridage		●	●																			
	Qualité de surface insuffisante sur les parois	Forte usure de l'arête de coupe Conditions de coupe inadaptées Bourrage copeaux	●																					
	Qualité de surface insuffisante sur les surfaces planes	L'arête de coupe de face ne présente aucun angle concave Grande avance																						
	Déviations	Forte usure de l'arête de coupe Conditions de coupe inadaptées Manque de rigidité de la fraise	●																					
	Précision de mesure insuffisante	Conditions de coupe inadaptées Faible résistance de bridage																						
Bavures, écaillage etc.	Formation de bavures et de copeaux	Conditions de coupe inadaptées Grand angle de spirale																						
	Mauvaise formation de bavures	Abrasion en cratère Conditions de coupe inadaptées	●																					
Mauvaise formation copeaux	Bourrage copeaux.	Volume d'enlèvement de copeaux trop important Poche de copeau manquante																						

Notes

A series of horizontal dashed lines for writing notes.

TABLEAU DE COMPARAISON DES MATIÈRES

■ ACIER CARBONE

Allemagne		Royaume-uni		France	Italie	Espagne	Suède	Japon	USA	Chine
W-nr.	DIN	BS	EN	AFNOR	UNI	UNE	SS	JIS	AISI/SAE	GB
1.0038	RSt.37-2	4360 40 C	–	E 24-2 Ne	–	–	1311	STKM 12A STKM 12C	A570.36	15
1.0401	C15	080M15	–	CC12	C15, C16	F.111	1350	–	1015	15
1.0402	C22	050A20	2C	CC20	C20, C21	F.112	1450	–	1020	20
1.0715	9SMn28	230M07	1A	S250	CF9SMn28	F.2111 11SMn28	1912	SUM22	1213	Y15
1.0718	9SMnPb28	–	–	S250Pb	CF9SMnPb28	11SMnPb28	1914	SUM22L	12L13	–
1.0722	10SPb20	–	–	10PbF2	CF10Pb20	10SPb20	–	–	–	–
1.0736	9SMn36	240M07	1B	S300	CF9SMn36	12SMn35	–	–	1215	Y13
1.0737	9SMnPb36	–	–	S300Pb	CF9SMnPb36	12SMnP35	1926	–	12L14	–
1.1141	Ck15	080M15	32C	XC12	C16	C15K	1370	S15C	1015	15
1.1158	Ck25	–	–	–	–	–	–	S25C	1025	25
1.8900	StE380	4360 55 E	–	–	FeE390KG	–	2145	–	A572-60	–
1.0501	C35	060A35	–	CC35	C35	F.113	1550	–	1035	35
1.0503	C45	080M46	–	CC45	C45	F.114	1650	–	1045	45
1.0726	35S20	212M36	8M	35MF4	–	F210G	1957	–	1140	–
1.1157	40Mn4	150M36	15	35M5	–	–	–	–	1039	40Mn
1.1167	36Mn5	–	–	40M5	–	36Mn5	2120	SMn438(H)	1335	35Mn2
1.1170	28Mn6	150M28	14A	20M5	C28Mn	–	–	SCMn1	1330	30Mn
1.1183	Cf35	060A35	–	XC38TS	C36	–	1572	S35C	1035	35Mn
1.1191	Ck45	080M46	–	XC42	C45	C45K	1672	S45C	1045	Ck45
1.1213	Cf53	060A52	–	XC48TS	C53	–	1674	S50C	1050	50
1.0535	C55	070M55	9	–	C55	–	1655	–	1055	55
1.0601	C60	080A62	43D	CC55	C60	–	–	–	1060	60
1.1203	Ck55	070M55	–	XC55	C50	C55K	–	S55C	1055	55
1.1221	Ck60	080A62	43D	XC60	C60	–	1678	S58C	1060	60Mn
1.1274	Ck101	060A96	–	XC100	–	F.5117	1870	–	1095	–
1.1545	C105W1	BW1A	–	Y105	C36KU	F.5118	1880	SK3	W1	–
1.1545	C105W1	BW2	–	Y120	C120KU	F.515	2900	SUP4	W210	–

■ ALLIAGE ACIER

Allemagne		Royaume-uni		France	Italie	Espagne	Suède	Japon	USA	Chine
W-nr.	DIN	BS	EN	AFNOR	UNI	UNE	SS	JIS	AISI/SAE	GB
1.0144	St.44.2	4360 43 C	–	E28-3	–	–	1412	SM400A, SM400B SM400C	A573-81	–
1.0570	St52-3	4360 50 B	–	E36-3	Fe52BFN Fe52CFN	–	2132	SM490A, SM490B SM490C	–	–
1.0841	St52-3	150M19	–	20MC5	Fe52	F.431	2172	–	5120	–
1.0904	55Si7	250A53	45	55S7	55Si8	56Si7	2085	–	9255	55Si2Mn
1.0961	60SiCr7	–	–	60SC7	60SiCr8	60SiCr8	–	–	9262	–
1.3505	100Cr6	534A99	31	100C6	100Cr6	F.131	2258	SUJ2	ASTM 52100	Gr15, 45G
1.5415	15Mo3	1501-240	–	15D3	16Mo3KW	16Mo3	2912	–	ASTM A204Gr.A	–
1.5423	16Mo5	1503-245-420	–	–	16Mo5	16Mo5	–	–	4520	–
1.5622	14Ni6	–	–	16N6	14Ni6	15Ni6	–	–	ASTM A350LF5	–
1.5662	X8Ni9	1501-509-510	–	–	X10Ni9	XBNI09	–	–	ASTM A353	–
1.5710	36NiCr6	640A35	111A	35NC6	–	–	–	SNC236	3135	–
1.5732	14NiCr10	–	–	14NC11	16NiCr11	15NiCr11	–	SNC415(H)	3415	–
1.5752	14NiCr14	655M13	36A	12NC15	–	–	–	SNC815(H)	3415, 3310	–
1.6523	21NiCrMo2	805M20	362	20NCD2	20NiCrMo2	20NiCrMo2	2506	SNCM220(H)	8620	–
1.6546	40NiCrMo22	311-Type 7	–	–	40NiCrMo2(KB)	40NiCrMo2	–	SNCM240	8740	–
1.6587	17CrNiMo6	820A16	–	18NCD6	–	14NiCrMo13	–	–	–	–
1.7015	15Cr3	523M15	–	12C3	–	–	–	SCr415(H)	5015	15Cr

Allemagne		Royaume-uni		France	Italie	Espagne	Suède	Japon	USA	Chine
W-nr.	DIN	BS	EN	AFNOR	UNI	UNE	SS	JIS	AISI/SAE	GB
1.7045	42Cr4	–	–	–	–	42Cr4	2245	SCr440	5140	40Cr
1.7176	55Cr3	527A60	48	55C3	–	–	–	SUP9(A)	5155	20CrMn
1.7262	15CrMo5	–	–	12CD4	–	12CrMo4	2216	SCM415(H)	–	–
1.7335	13CrMo4 4	1501-620Gr27	–	15CD3.5 15CD4.5	14CrMo45	14CrMo45	–	–	ASTM A182 F11, F12	–
1.7380	10CrMo910	1501-622 Gr31, 45	–	12CD9 12CD10	12CrMo9 12CrMo10	TU.H	2218	–	ASTM A182 F.22	–
1.7715	14MoV63	1503-660-440	–	–	–	13MoCrV6	–	–	–	–
1.8523	39CrMoV13 9	897M39	40C	–	36CrMoV12	–	–	–	–	–
1.6511	36CrNiMo4	816M40	110	40NCD3	38NiCrMo4(KB)	35NiCrMo4	–	–	9840	–
1.6582	34CrNiMo6	817M40	24	35NCD6	35NiCrMo6(KB)	–	2541	–	4340	40CrNiMoA
1.7033	34Cr4	530A32	18B	32C4	34Cr4(KB)	35Cr4	–	SCr430(H)	5132	35Cr
1.7035	41Cr4	530M40	18	42C4	41Cr4	42Cr4	–	SCr440(H)	5140	40Cr
1.7131	16MnCr5	(527M20)	–	16MC5	16MnCr5	16MnCr5	2511	–	5115	18CrMn
1.7218	25CrMo4	1717CDS110 708M20	–	25CD4	25CrMo4(KB)	55Cr3	2225	SCM420 SCM430	4130	30CrMn
1.7220	34CrMo4	708A37	19B	35CD4	35CrMo4	34CrMo4	2234	SCM432 SCCRM3	4137 4135	35CrMo
1.7223	41CrMo4	708M40	19A	42CD4TS	41CrMo4	42CrMo4	2244	SCM 440	4140 4142	40CrMoA
1.7225	42CrMo4	708M40	19A	42CD4	42CrMo4	42CrMo4	2244	SCM440(H)	4140	42CrMo 42CrMnMo
1.7361	32CrMo12	722M24	40B	30CD12	32CrMo12	F.124.A	2240	–	–	–
1.8159	50CrV4	735A50	47	50CV4	50CrV4	51CrV4	2230	SUP10	6150	50CrVA
1.8509	41CrAlMo7	905M39	41B	40CAD6 40CAD2	41CrAlMo7	41CrAlMo7	2940	–	–	–
1.2067	100Cr6	BL3	–	Y100C6	–	100Cr6	–	–	L3	CrV, 9SiCr
1.2419	105WCr6	–	–	105WC13	100WCr6 107WCr5KU	105WCr5	2140	SKS31 SKS2, SKS3	–	CrWMo
1.2713	55NiCrMoV6	BH224/5	–	55NCDV7	–	F.520.S	–	SKT4	L6	5CrNiMo
1.5662	X8Ni9	1501-509	–	–	X10Ni9	XBNI09	–	–	ASTM A353	–
1.5680	12Ni19	–	–	Z18N5	–	–	–	–	2515	–
1.6657	14NiCrMo134	832M13	36C	–	15NiCrMo13	14NiCrMo131	–	–	–	–
1.2080	X210Cr12	BD3	–	Z200C12	X210Cr13KU X250Cr12KU	X210Cr12	–	SKD1	D3 ASTM D3	Cr12
1.2601	X153CrMoV12	BD2	–	–	X160CrMoV12	–	–	SKD11	D2	Cr12MoV
1.2363	X100CrMoV5	BA2	–	Z100CDV5	X100CrMoV5	F.5227	2260	SKD12	A2	Cr5Mo1V
1.2344	X40CrMoV51 X40CrMoV51	BH13	–	Z40CDV5	X35CrMoV05KU X40CrMoV51KU	X40CrMoV5	2242	SKD61	H13 ASTM H13	40CrMoV5
1.2436	X210CrW12	–	–	–	X215CrW121KU	X210CrW12	2312	SKD2	–	–
1.2542	45WCrV7	BS1	–	–	45WCrV8KU	45WCrSi8	2710	–	S1	–
1.2581	X30WCrV93	BH21	–	Z30WCV9	X28W09KU	X30WCrV9	–	SKD5	H21	30WCrV9
1.2601	X165CrMoV12	–	–	–	X165CrMoV12KU	X160CrMoV12	2310	–	–	–
1.2833	100V1	BW2	–	Y1105V	–	–	–	SKS43	W210	V
1.3255	S 18-1-2-5	BT4	–	Z80WKCV	X78WCo1805KU	HS18-1-1-5	–	SKH3	T4	W18Cr4VCo5
1.3355	S 18-0-1	BT1	–	Z80WCV	X75W18KU	HS18-0-1	–	SKH2	T1	–
1.3401	G-X120Mn12	Z120M12	–	Z120M12	XG120Mn12	X120MN12	–	SCMnH/1	–	–
1.4718	X45CrSi93	401S45	52	Z45CS9	X45CrSi8	F.322	–	SUH1	HW3	X45CrSi93
1.3343	S6-5-2	4959BA2	–	Z40CSD10	15NiCrMo13	–	2715	SUH3	D3	–
1.3343	S6/5/2	BM2	–	Z85WDCV	HS6-5-2-2	F.5603	2722	SKH9, SKH51	M2	–
1.3348	S 2-9-2	–	–	–	HS2-9-2	HS2-9-2	2782	–	M7	–
1.3243	S6/5/2/5	BM35	–	6-5-2-5	HS6-5-2-5	F.5613	2723	SKH55	M35	–

TABLEAU DE COMPARAISON DES MATIÈRES

■ ACIER INOXYDABLE (FERRITIQUE, MARTENSITIQUE)

Allemagne		Royaume-uni		France	Italie	Espagne	Suède	Japon	USA	Chine
W-nr.	DIN	BS	EN	AFNOR	UNI	UNE	SS	JIS	AISI/SAE	GB
1.4000	X7Cr13	403S17	–	Z6C13	X6Cr13	F.3110	2301	SUS403	403	OCr13 1Cr12
1.4001	X7Cr14	–	–	–	–	F.8401	–	–	–	–
1.4005	X12CrS13	416S21	–	Z11CF13	X12CrS13	F.3411	2380	SUS416	416	–
1.4006	X10Cr13	410S21	56A	Z10C14	X12Cr13	F.3401	2302	SUS410	410	1Cr13
1.4016	X8Cr17	430S15	60	Z8C17	X8Cr17	F.3113	2320	SUS430	430	1Cr17
1.4027	G-X20Cr14	420C29	56B	Z20C13M	–	–	–	SCS2	–	–
1.4034	X46Cr13	420S45	56D	Z40CM Z38C13M	X40Cr14	F.3405	2304	SUS420J2	–	4Cr13
1.4003	–	405S17	–	Z8CA12	X6CrAl13	–	–	–	405	–
1.4021	–	420S37	–	Z8CA12	X20Cr13	–	2303	–	420	–
1.4057	X22CrNi17	431S29	57	Z15CNi6.02	X16CrNi16	F.3427	2321	SUS431	431	1Cr17Ni2
1.4104	X12CrMoS17	–	–	Z10CF17	X10CrS17	F.3117	2383	SUS430F	430F	Y1Cr17
1.4113	X6CrMo17	434S17	–	Z8CD17.01	X8CrMo17	–	2325	SUS434	434	1Cr17Mo
1.4313	X5CrNi134	425C11	–	Z4CND13.4M	(G)X6CrNi304	–	2385	SCS5	CA6-NM	–
1.4724	X10CrA113	403S17	–	Z10C13	X10CrA112	F.311	–	SUS405	405	OCr13Al
1.4742	X10CrA118	430S15	60	Z10CAS18	X8Cr17	F.3113	–	SUS430	430	Cr17
1.4747	X80CrNiSi20	443S65	59	Z80CSN20.02	X80CrSiNi20	F.320B	–	SUH4	HNV6	–
1.4762	X10CrA124	–	–	Z10CAS24	X16Cr26	–	2322	SUH446	446	2Cr25N
1.4871	X53CrMnNiN219	349S54	–	Z52CMN21.09	X53CrMnNiN219	–	–	SUH35	EV8	5Cr2Mn9Ni4N
1.4521	X1CrMoTi182	–	–	–	–	–	2326	–	S44400	–
1.4922	X20CrMoV12-1	–	–	–	X20CrMoNi1201	–	2317	–	–	–
1.4542	–	–	–	Z7CNU17-04	–	–	–	–	630	–

■ ACIER INOXYDABLE (AUSTÉNITIQUE)

Allemagne		Royaume-uni		France	Italie	Espagne	Suède	Japon	USA	Chine
W-nr.	DIN	BS	EN	AFNOR	UNI	UNE	SS	JIS	AISI/SAE	GB
1.4306	X2CrNi1911	304S11	–	Z2CN18.10	X2CrNi18.11	–	2352	SUS304L	304L	OCr19Ni10
1.4350	X5CrNi189	304S11	58E	Z6CN18.09	X5CrNi1810	F.3551 F.3541 F.3504	2332	SUS304	304	OCr18Ni9
1.4305	X12CrNiS188	303S21	58M	Z10CNF18.09	X10CrNiS18.09	F.3508	2346	SUS303	303	1Cr18Ni9MoZr
–	–	304C12	–	Z3CN19.10	–	–	2333	SUS304L	–	–
1.4306	X2CrNi189	304S12	–	Z2CrNi1810	X2CrNi18.11	F.3503	2352	SCS19	304L	–
1.4310	X12CrNi177	–	–	Z12CN17.07	X12CrNi1707	F.3517	2331	SUS301	301	Cr17Ni7
1.4311	X2CrNiN1810	304S62	–	Z2CN18.10	–	–	2371	SUS304LN	304LN	–
1.4401	X5CrNiMo1810	316S16	58J	Z6CND17.11	X5CrNiMo1712	F.3543	2347	SUS316	316	OCr17Ni11Mo2
1.4308	G-X6CrNi189	304C15	–	Z6CN18.10M	–	–	–	SCS13	–	–
1.4408	G-X6CrNiMo1810	316C16	–	–	–	F.8414	–	SCS14	–	–
1.4581	G-X5CrNiMoNb1810	318C17	–	Z4CNDNb1812M	XG8CrNiMo1811	–	–	SCS22	–	–
1.4429	X2CrNiMoN1813	–	–	Z2CND17.13	–	–	2375	SUS316LN	316LN	OCr17Ni13Mo
1.4404	–	316S13	–	Z2CND17.12	X2CrNiMo1712	–	2348	–	316L	–
1.4435	X2CrNiMo1812	316S13	–	Z2CND17.12	X2CrNiMo1712	–	2353	SCS16 SUS316L	316L	OCr27Ni12Mo3
1.4436	–	316S13	–	Z6CND18-12-03	X8CrNiMo1713	–	2343, 2347	–	316	–
1.4438	X2CrNiMo1816	317S12	–	Z2CND19.15	X2CrNiMo1816	–	2367	SUS317L	317L	OCr19Ni13Mo
1.4539	X1NiCrMo	–	–	Z6CNT18.10	–	–	2562	–	UNS V 0890A	–
1.4541	X10CrNiTi189	321S12	58B	Z6CNT18.10	X6CrNiTi1811	F.3553 F.3523	2337	SUS321	321	1Cr18Ni9Ti
1.4550	X10CrNiNb189	347S17	58F	Z6CNNb18.10	X6CrNiNb1811	F.3552 F.3524	2338	SUS347	347	1Cr18Ni11Nb
1.4571	X10CrNiMoTi1810	320S17	58J	Z6CNDT17.12	X6CrNiMoTi1712	F.3535	2350	–	316Ti	Cr18Ni12Mo2T
1.4583	X10CrNiMoNb1812	–	–	Z6CNDNb1713B	X6CrNiMoNb1713	–	–	–	318	Cr17Ni12Mo3Mb

Allemagne		Royaume-uni		France	Italie	Espagne	Suède	Japon	USA	Chine
W-nr.	DIN	BS	EN	AFNOR	UNI	UNE	SS	JIS	AISI/SAE	GB
1.4828	X15CrNiSi2012	309S24	–	Z15CNS20.12	X6CrNi2520	–	–	SUH309	309	1Cr23Ni13
1.4845	X12CrNi2521	310S24	–	Z12CN2520	X6CrNi2520	F.331	2361	SUH310	310S	OCr25Ni20
1.4406	X10CrNi18.08	–	58C	Z1NCDU25.20	–	F.8414	2370	SCS17	308	–
1.4418	X4CrNiMo165	–	–	Z6CND16-04-01	–	–	–	–	–	–
1.4568	–	316S111	–	Z8CNA17-07	X2CrNiMo1712	–	–	–	17-7PH	–
1.4504	–	–	–	–	–	–	–	–	–	–
1.4563	–	–	–	Z1NCDU31-27-03 Z1CNDU20-18-06AZ	–	–	2584 2378	–	NO8028 S31254	–
1.4878	X12CrNiTi189	321S32	58B, 58C	Z6CNT18.12B	X6CrNiTi18.11	F.3523	–	SUS321	321	1Cr18Ni9Ti

■ ACIERS RÉSIDANT À LA CHALEUR

Allemagne		Royaume-uni		France	Italie	Espagne	Suède	Japon	USA	Chine
W-nr.	DIN	BS	EN	AFNOR	UNI	UNE	SS	JIS	AISI/SAE	GB
1.4864	X12NiCrSi3616	–	–	Z12NCS35.16	–	–	–	SUH330	330	–
1.4865	G-X40NiCrSi3818	330C11	–	–	XG50NiCr3919	–	–	SCH15	HT, HT 50	–

■ FONTE GRISE

Allemagne		Royaume-uni		France	Italie	Espagne	Suède	Japon	USA	Chine
W-nr.	DIN	BS	EN	AFNOR	UNI	UNE	SS	JIS	AISI/SAE	GB
–	–	–	–	–	–	–	0100	–	–	–
–	GG 10	–	–	Ft 10 D	–	–	0110	FC100	No 20 B	–
0.6015	GG 15	Grade 150	–	Ft 15 D	G15	FG15	0115	FC150	No 25 B	HT150
0.6020	GG 20	Grade 220	–	Ft 20 D	G20	–	0120	FC200	No 30 B	HT200
0.6025	GG 25	Grade 260	–	Ft 25 D	G25	FG25	0125	FC250	No 35 B	HT250
–	–	–	–	–	–	–	–	–	No 40 B	–
0.6030	GG 30	Grade 300	–	Ft 30 D	G30	FG30	0130	FC300	No 45 B	HT300
0.6035	GG 35	Grade 350	–	Ft 35 D	G35	FG35	0135	FC350	No 50 B	HT350
0.6040	GG 40	Grade 400	–	Ft 40 D	–	–	0140	–	No 55 B	HT400
0.6660	GGL NiCr202	L-NiCuCr202	–	L-NC 202	–	–	0523	–	A436 Type 2	–

■ FONTE DUCTILE

Allemagne		Royaume-uni		France	Italie	Espagne	Suède	Japon	USA	Chine
W-nr.	DIN	BS	EN	AFNOR	UNI	UNE	SS	JIS	AISI/SAE	GB
0.7040	GGG 40	SNG 420/12	–	FCS 400-12	GS 370-17	FGE 38-17	07 17-02	FCD400	60-40-18	QT400-18
–	GGG 40.3	SNG 370/17	–	FGS 370-17	–	–	07 17-12	–	–	–
0.7033	GGG 35.3	–	–	–	–	–	07 17-15	–	–	–
0.7050	GGG 50	SNG 500/7	–	FGS 500-7	GS 500	FGE 50-7	07 27-02	FCD500	80-55-06	QT500-7
0.7660	GGG NiCr202	Grade S6	–	S-NC202	–	–	07 76	–	A43D2	–
–	GGG NiMn137	L-NiMn 137	–	L-MN 137	–	–	07 72	–	–	–
–	GGG 60	SNG 600/3	–	FGS 600-3	–	–	07 32-03	FCD600	–	QT600-3
0.7070	GGG 70	SNG 700/2	–	FGS 700-2	GS 700-2	FGS 70-2	07 37-01	FCD700	100-70-03	QT700-18

■ FONTE MALLÉABLE

Allemagne		Royaume-uni		France	Italie	Espagne	Suède	Japon	USA	Chine
W-nr.	DIN	BS	EN	AFNOR	UNI	UNE	SS	JIS	AISI/SAE	GB
–	–	8 290/6	–	MN 32-8	–	–	08 14	FCMB310	–	–
–	GTS-35	B 340/12	–	MN 35-10	–	–	08 15	FCMW330	32510	–
0.8145	GTS-45	P 440/7	–	Mn 450	GMN45	–	08 52	FCMW370	40010	–
0.8155	GTS-55	P 510/4	–	MP 50-5	GMN55	–	08 54	FCMP490	50005	–
–	GTS-65	P 570/3	–	MP 60-3	–	–	08 58	FCMP540	70003	–
0.8165	GTS-65-02	P 570/3	–	Mn 650-3	GMN 65	–	08 56	FCMP590	A220-70003	–
–	GTS-70-02	P 690/2	–	Mn 700-2	GMN 70	–	08 62	FCMP690	A220-80002	–

ÉTAT DE SURFACE

ÉTAT DE SURFACE

(De JIS B 601-1994)

Type	Symbole	Méthode de mesure	Exemple de mesure (Schéma)
Rugosité moyenne	Ra	<p>Les écarts de surface se présentent sous la forme de rugosité créée par le saut axial des plaquettes, la forme et l'usure des arêtes et par les irrégularités de l'écoulement des copeaux. La mesure de l'état de surface s'effectue sur une longueur linéaire. Ra mesure l'état de surface par rapport à une ligne moyenne des écarts. Ra est exprimé en microns et est calculé à partir de l'équation suivante :</p> $Ra = \frac{1}{\ell} \int_0^{\ell} f(x) dx$	
Poids maximum	Rz	<p>La plupart des enregistrements d'états de surface sont dotés de filtres électriques permettant d'éliminer l'ondulation (écart de forme). Rz max. indique pour une longueur référence mesurée la différence maximum exprimée en microns entre le point le plus haut et le point le plus bas mesuré en (μm). Remarque) Pour une longueur référence donnée, Rz indique l'état de surface moyen arithmétique de la différence entre les 5 points les plus bas mesurés. Rz est exprimé en micron (μm). $Rz = R_p + R_v$</p>	
Rugosité moyenne en dix points	RzJIS	<p>RzJIS sera la longueur de référence sélectionnée de la courbe moyenne et la somme de la valeur moyenne des valeurs absolues des hauteurs de cinq sommets de profil les plus hauts (Yp) et les profondeurs de cinq points de profil les plus bas (Yv) mesurés dans la direction verticale de la ligne moyenne de cette partie sélectionnée et cette somme est exprimée en microns (μm).</p> $Rz_{JIS} = \frac{(Y_{p1} + Y_{p2} + Y_{p3} + Y_{p4} + Y_{p5}) + (Y_{v1} + Y_{v2} + Y_{v3} + Y_{v4} + Y_{v5})}{5}$	<p>$Y_{p1}, Y_{p2}, Y_{p3}, Y_{p4}, Y_{p5}$: Les 5 points les plus hauts de la longueur référence mesurée. $Y_{v1}, Y_{v2}, Y_{v3}, Y_{v4}, Y_{v5}$: Les 5 points les plus bas de la longueur référence mesurée.</p>

DONNÉES TECHNIQUES

P

RELATION ENTRE LA RUGOSITÉ MOYENNE (Ra) ET DÉSIGNATION CONVENTIONNELLE (DONNÉE DE RÉFÉRENCE)

Rugosité moyenne Ra		Poids maximum Rz	Rugosité moyenne en dix points RzJIS	Longueur étalon Rz • RzJIS l (mm)	Symbole
Séries standards	Moyenne arithmétique λc (mm)	Séries standards			
0.012 a	0.08	0.05s	0.05z	0.08	▽▽▽▽
0.025 a		0.1 s	0.1 z		
0.05 a	0.25	0.2 s	0.2 z	0.25	
0.1 a		0.4 s	0.4 z		
0.2 a		0.8 s	0.8 z		
0.4 a	0.8	1.6 s	1.6 z	0.8	▽▽▽
0.8 a		3.2 s	3.2 z		
1.6 a		6.3 s	6.3 z		
3.2 a		12.5 s	12.5 z		
6.3 a	2.5	25 s	25 z	2.5	▽▽
12.5 a		50 s	50 z		
25 a	8	100 s	100 z	8	▽
50 a		200 s	200 z		
100 a		400 s	400 z		

*La corrélation entre les trois rugosités est d'ordre théorique.

*La mesure de Rz et RzJIS est faite par la moyenne arithmétique des valeurs mesurées sur la longueur étalon multipliées respectivement par 5.

CORRESPONDANCE DURETÉ

MATIÈRES - CORRESPONDANCE DURETÉ ACIER

Dureté Brinell (HB) Bille 10mm,3000kgf		Dureté Vickers	Dureté Rockwell				Dureté shore	Résistance à la traction (Env.) MPa	Dureté Brinell (HB) Bille 10mm,3000kgf		Dureté Vickers	Dureté Rockwell				Dureté shore	Résistance à la traction (Env.) MPa	
Bille standard	Bille carbure de tungstène		Échelle A 60kgf, Diamant Cône diamant	Échelle B, 100kgf, Bille 1/16"	Échelle C, 150kgf, Diamant Cône diamant	Échelle D, 100kgf, Diamant Cône diamant			Bille standard	Bille carbure de tungstène		Échelle A 60kgf, Diamant Cône diamant	Échelle B, 100kgf, Bille 1/16"	Échelle C, 150kgf, Diamant Cône diamant	Échelle D, 100kgf, Diamant Cône diamant			
		(HV)	(HRA)	(HRB)	(HRC)	(HRD)	(HS)			(HV)	(HRA)	(HRB)	(HRC)	(HRD)	(HS)			
-	-	940	85.6	-	68.0	76.9	97	-	429	429	455	73.4	-	45.7	59.7	61	1510	
-	-	920	85.3	-	67.5	76.5	96	-	415	415	440	72.8	-	44.5	58.8	59	1460	
-	-	900	85.0	-	67.0	76.1	95	-	401	401	425	72.0	-	43.1	57.8	58	1390	
-	(767)	880	84.7	-	66.4	75.7	93	-	388	388	410	71.4	-	41.8	56.8	56	1330	
-	(757)	860	84.4	-	65.9	75.3	92	-	375	375	396	70.6	-	40.4	55.7	54	1270	
-	(745)	840	84.1	-	65.3	74.8	91	-	363	363	383	70.0	-	39.1	54.6	52	1220	
-	(733)	820	83.8	-	64.7	74.3	90	-	352	352	372	69.3	(110.0)	37.9	53.8	51	1180	
-	(722)	800	83.4	-	64.0	73.8	88	-	341	341	360	68.7	(109.0)	36.6	52.8	50	1130	
-	(712)	-	-	-	-	-	-	-	331	331	350	68.1	(108.5)	35.5	51.9	48	1095	
-	(710)	780	83.0	-	63.3	73.3	87	-	321	321	339	67.5	(108.0)	34.3	51.0	47	1060	
-	(698)	760	82.6	-	62.5	72.6	86	-	-	-	-	-	-	-	-	-	-	
-	(684)	740	82.2	-	61.8	72.1	-	-	311	311	328	66.9	(107.5)	33.1	50.0	46	1025	
-	(682)	737	82.2	-	61.7	72.0	84	-	302	302	319	66.3	(107.0)	32.1	49.3	45	1005	
-	(670)	720	81.8	-	61.0	71.5	83	-	293	293	309	65.7	(106.0)	30.9	48.3	43	970	
-	(656)	700	81.3	-	60.1	70.8	-	-	285	285	301	65.3	(105.5)	29.9	47.6	-	950	
-	(653)	697	81.2	-	60.0	70.7	81	-	277	277	292	64.6	(104.5)	28.8	46.7	41	925	
-	(647)	690	81.1	-	59.7	70.5	-	-	269	269	284	64.1	(104.0)	27.6	45.9	40	895	
-	(638)	680	80.8	-	59.2	70.1	80	-	262	262	276	63.6	(103.0)	26.6	45.0	39	875	
-	630	670	80.6	-	58.8	69.8	-	-	255	255	269	63.0	(102.0)	25.4	44.2	38	850	
-	627	667	80.5	-	58.7	69.7	79	-	248	248	261	62.5	(101.0)	24.2	43.2	37	825	
-	-	677	80.7	-	59.1	70.0	-	-	241	241	253	61.8	100	22.8	42.0	36	800	
-	601	640	79.8	-	57.3	68.7	77	-	235	235	247	61.4	99.0	21.7	41.4	35	785	
-	-	640	79.8	-	57.3	68.7	-	-	229	229	241	60.8	98.2	20.5	40.5	34	765	
-	578	615	79.1	-	56.0	67.7	75	-	223	223	234	-	97.3	(18.8)	-	-	-	
-	-	607	78.8	-	55.6	67.4	-	-	217	217	228	-	96.4	(17.5)	-	33	725	
-	555	591	78.4	-	54.7	66.7	73	-	212	212	222	-	95.5	(16.0)	-	-	705	
-	-	607	78.8	-	55.6	67.4	-	-	207	207	218	-	94.6	(15.2)	-	32	690	
-	534	569	77.8	-	53.5	65.8	71	-	201	201	212	-	93.8	(13.8)	-	31	675	
-	-	579	78.0	-	54.0	66.1	-	2015	197	197	207	-	92.8	(12.7)	-	30	655	
-	534	569	77.8	-	53.5	65.8	71	-	192	192	202	-	91.9	(11.5)	-	29	640	
-	-	533	77.1	-	52.5	65.0	-	1915	187	187	196	-	90.7	(10.0)	-	-	620	
-	514	547	76.9	-	52.1	64.7	70	-	1890	183	183	192	-	90.0	(9.0)	-	28	615
(495)	-	539	76.7	-	51.6	64.3	-	1855	179	179	188	-	89.0	(8.0)	-	27	600	
-	-	530	76.4	-	51.1	63.9	-	1825	174	174	182	-	87.8	(6.4)	-	-	585	
-	495	528	76.3	-	51.0	63.8	68	-	1820	170	170	178	-	86.8	(5.4)	-	26	570
(477)	-	516	75.9	-	50.3	63.2	-	1780	167	167	175	-	86.0	(4.4)	-	-	560	
-	-	508	75.6	-	49.6	62.7	-	1740	163	163	171	-	85.0	(3.3)	-	25	545	
-	477	508	75.6	-	49.6	62.7	66	-	1740	156	156	163	-	82.9	(0.9)	-	525	
(461)	-	495	75.1	-	48.8	61.9	-	1680	149	149	156	-	80.8	-	-	23	505	
-	-	491	74.9	-	48.5	61.7	-	1670	143	143	150	-	78.7	-	-	22	490	
-	461	491	74.9	-	48.5	61.7	65	-	1670	137	137	143	-	76.4	-	-	21	460
444	-	474	74.3	-	47.2	61.0	-	1595	126	126	132	-	74.0	-	-	-	450	
-	-	472	74.2	-	47.1	60.8	-	1585	126	126	132	-	72.0	-	-	20	435	
-	444	472	74.2	-	47.1	60.8	63	-	1585	121	121	127	-	69.8	-	-	19	415
-	-	472	74.2	-	47.1	60.8	-	1585	116	116	122	-	67.6	-	-	18	400	
-	444	472	74.2	-	47.1	60.8	63	-	1585	111	111	117	-	65.7	-	-	15	385

Remarque 1) Les valeurs du tableau ci-dessus sont les valeurs métriques du AMS Metals Handbook.

Remarque 2) 1MPa=1N/mm²

Remarque 3) Les valeurs entre sont peu utilisées. Cette liste est tirée de JIS Handbook Steel I.

P

DONNÉES TECHNIQUES

TABLE DE TOLÉRANCES DES TROUS

Classification, dimensions standards (mm)		Classification des zones de tolérance géométrique de trous															
>	≤	B10	C9	C10	D8	D9	D10	E7	E8	E9	F6	F7	F8	G6	G7	H6	H7
-	3	+180	+85	+100	+34	+45	+60	+24	+28	+39	+12	+16	+20	+8	+12	+6	+10
		+140	+60	+60	+20	+20	+20	+14	+14	+14	+6	+6	+6	+2	+2	0	0
3	6	+188	+100	+118	+48	+60	+78	+32	+38	+50	+18	+22	+28	+12	+16	+8	+12
		+140	+70	+70	+30	+30	+30	+20	+20	+20	+10	+10	+10	+4	+4	0	0
6	10	+208	+116	+138	+62	+76	+98	+40	+47	+61	+22	+28	+35	+14	+20	+9	+15
		+150	+80	+80	+40	+40	+40	+25	+25	+25	+13	+13	+13	+5	+5	0	0
10	14	+220	+138	+165	+77	+93	+120	+50	+59	+75	+27	+34	+43	+17	+24	+11	+18
		+150	+95	+95	+50	+50	+50	+32	+32	+32	+16	+16	+16	+6	+6	0	0
14	18	+244	+162	+194	+98	+117	+149	+61	+73	+92	+33	+41	+53	+20	+28	+13	+21
		+160	+110	+110	+65	+65	+65	+40	+40	+40	+20	+20	+20	+7	+7	0	0
18	24	+270	+182	+220	+119	+142	+180	+75	+89	+112	+41	+50	+64	+25	+34	+16	+25
		+170	+120	+120	+80	+80	+80	+50	+50	+50	+25	+25	+25	+9	+9	0	0
24	30	+280	+192	+230	+146	+174	+220	+90	+106	+134	+49	+60	+76	+29	+40	+19	+30
		+180	+130	+130	+100	+100	+100	+60	+60	+60	+30	+30	+30	+10	+10	0	0
30	40	+310	+214	+260	+174	+207	+260	+107	+126	+159	+58	+71	+90	+34	+47	+22	+35
		+190	+140	+140	+120	+120	+120	+72	+72	+72	+36	+36	+36	+12	+12	0	0
40	50	+320	+224	+270	+208	+245	+305	+125	+148	+185	+68	+83	+106	+39	+54	+25	+40
		+200	+150	+150	+145	+145	+145	+85	+85	+85	+43	+43	+43	+14	+14	0	0
50	65	+360	+257	+310	+271	+320	+400	+162	+191	+240	+88	+108	+137	+49	+69	+32	+52
		+220	+170	+170	+190	+190	+190	+110	+110	+110	+56	+56	+56	+17	+17	0	0
65	80	+380	+267	+320	+242	+285	+355	+146	+172	+215	+79	+96	+122	+44	+61	+29	+46
		+240	+180	+180	+170	+170	+170	+100	+100	+100	+50	+50	+50	+15	+15	0	0
80	100	+420	+300	+360	+605	+395	+465	+271	+320	+400	+88	+108	+137	+49	+69	+32	+52
		+260	+200	+200	+420	+280	+280	+190	+190	+190	+56	+56	+56	+17	+17	0	0
100	120	+440	+310	+370	+525	+355	+445	+242	+285	+355	+79	+96	+122	+44	+61	+29	+46
		+280	+210	+210	+340	+240	+240	+170	+170	+170	+50	+50	+50	+15	+15	0	0
120	140	+470	+330	+390	+565	+375	+445	+242	+285	+355	+79	+96	+122	+44	+61	+29	+46
		+310	+230	+230	+380	+260	+260	+170	+170	+170	+50	+50	+50	+15	+15	0	0
140	160	+525	+355	+425	+605	+395	+465	+271	+320	+400	+88	+108	+137	+49	+69	+32	+52
		+340	+240	+240	+420	+280	+280	+190	+190	+190	+56	+56	+56	+17	+17	0	0
160	180	+565	+375	+445	+690	+430	+510	+271	+320	+400	+88	+108	+137	+49	+69	+32	+52
		+380	+260	+260	+480	+300	+300	+190	+190	+190	+56	+56	+56	+17	+17	0	0
180	200	+605	+395	+465	+750	+460	+540	+271	+320	+400	+88	+108	+137	+49	+69	+32	+52
		+420	+280	+280	+540	+330	+330	+190	+190	+190	+56	+56	+56	+17	+17	0	0
200	225	+830	+500	+590	+750	+460	+540	+271	+320	+400	+88	+108	+137	+49	+69	+32	+52
		+600	+360	+360	+540	+330	+330	+190	+190	+190	+56	+56	+56	+17	+17	0	0
225	250	+910	+540	+630	+830	+500	+590	+299	+350	+440	+182	+214	+265	+98	+119	+151	+54
		+680	+400	+400	+525	+350	+440	+182	+214	+265	+98	+119	+151	+54	+75	+36	+57
250	280	+990	+590	+690	+830	+500	+590	+299	+350	+440	+182	+214	+265	+98	+119	+151	+54
		+760	+440	+440	+525	+350	+440	+182	+214	+265	+98	+119	+151	+54	+75	+36	+57
280	315	+1010	+595	+690	+910	+540	+630	+299	+350	+440	+182	+214	+265	+98	+119	+151	+54
		+840	+480	+480	+525	+350	+440	+182	+214	+265	+98	+119	+151	+54	+75	+36	+57
315	355	+1090	+635	+730	+1010	+595	+690	+327	+385	+480	+198	+232	+290	+108	+131	+165	+60
		+840	+480	+480	+525	+350	+440	+182	+214	+265	+98	+119	+151	+54	+75	+36	+57
355	400	+1100	+640	+740	+1090	+635	+730	+327	+385	+480	+198	+232	+290	+108	+131	+165	+60
		+840	+480	+480	+525	+350	+440	+182	+214	+265	+98	+119	+151	+54	+75	+36	+57
400	450	+1190	+700	+810	+1100	+640	+740	+327	+385	+480	+198	+232	+290	+108	+131	+165	+60
		+840	+480	+480	+525	+350	+440	+182	+214	+265	+98	+119	+151	+54	+75	+36	+57
450	500	+1200	+710	+820	+1190	+700	+810	+327	+385	+480	+198	+232	+290	+108	+131	+165	+60
		+840	+480	+480	+525	+350	+440	+182	+214	+265	+98	+119	+151	+54	+75	+36	+57

Remarque 1) Les dénominations de la première ligne du tableau représentent les plages de tolérances, les autres lignes du tableau indiquent les valeurs mini et maxi en microns suivant les diamètres indiqués dans la colonne de gauche.

P

DONNÉES TECHNIQUES

Classification des zones de tolérance géométrique de trous

H8	H9	H10	JS6	JS7	K6	K7	M6	M7	N6	N7	P6	P7	R7	S7	T7	U7	X7
+14 0	+25 0	+40 0	± 3	± 5	0 -6	0 -10	-2 -8	-2 -12	-4 -10	-4 -14	-6 -12	-6 -16	-10 -20	-14 -24	-	-18 -28	-20 -30
+18 0	+30 0	+48 0	± 4	± 6	+2 -6	+3 -9	-1 -9	0 -12	-5 -13	-4 -16	-9 -17	-8 -20	-11 -23	-15 -27	-	-19 -31	-24 -36
+22 0	+36 0	+58 0	± 4.5	± 7	+2 -7	+5 -10	-3 -12	0 -15	-7 -16	-4 -19	-12 -21	-9 -24	-13 -28	-17 -32	-	-22 -37	-28 -43
+27 0	+43 0	+70 0	± 5.5	± 9	+2 -9	+6 -12	-4 -15	0 -18	-9 -20	-5 -23	-15 -26	-11 -29	-16 -34	-21 -39	-	-26 -44	-33 -51 -56
+33 0	+52 0	+84 0	± 6.5	± 10	+2 -11	+6 -15	-4 -17	0 -21	-11 -24	-7 -28	-18 -31	-14 -35	-20 -41	-27 -48	-	-33 -54	-46 -67 -77
+39 0	+62 0	+100 0	± 8	± 12	+3 -13	+7 -18	-4 -20	0 -25	-12 -28	-8 -33	-21 -37	-17 -42	-25 -50	-34 -59	-39 -64 -70	-51 -76 -86	-
+46 0	+74 0	+120 0	± 9.5	± 15	+4 -15	+9 -21	-5 -24	0 -30	-14 -33	-9 -39	-26 -45	-21 -51	-30 -60 -62	-42 -72 -78	-55 -85 -94	-76 -106 -121	-
+54 0	+87 0	+140 0	± 11	± 17	+4 -18	+10 -25	-6 -28	0 -35	-16 -38	-10 -45	-30 -52	-24 -59	-38 -73 -81	-58 -93 -101	-78 -113 -126	-111 -146 -166	-
+63 0	+100 0	+160 0	± 12.5	± 20	+4 -21	+12 -28	-8 -33	0 -40	-20 -45	-12 -52	-36 -61	-28 -68	-48 -88 -90 -93	-77 -117 -125 -133	-107 -147 -159 -171	-	-
+72 0	+115 0	+185 0	± 14.5	± 23	+5 -24	+13 -33	-8 -37	0 -46	-22 -51	-14 -60	-41 -70	-33 -79	-60 -105 -106	-113 -159 -169	-	-	-
+81 0	+130 0	+210 0	± 16	± 26	+5 -27	+16 -36	-9 -41	0 -52	-25 -57	-14 -66	-47 -79	-36 -88	-74 -126 -130	-	-	-	-
+89 0	+140 0	+230 0	± 18	± 28	+7 -29	+17 -40	-10 -46	0 -57	-26 -62	-16 -73	-51 -87	-41 -98	-87 -144 -150	-	-	-	-
+97 0	+155 0	+250 0	± 20	± 31	+8 -32	+18 -45	-10 -50	0 -63	-27 -67	-17 -80	-55 -95	-45 -108	-103 -166 -172	-	-	-	-

TABLEAU DE TOLÉRANCES DES ARBRES

Classification, dimensions standards (mm)		Classification des tolérances géométriques des arbres														
>	≤	b9	c9	d8	d9	e7	e8	e9	f6	f7	f8	g5	g6	h5	h6	h7
-	3	-140	-60	-20	-20	-14	-14	-14	-6	-6	-6	-2	-2	0	0	0
		-165	-85	-34	-45	-24	-28	-39	-12	-16	-20	-6	-8	-4	-6	-10
3	6	-140	-70	-30	-30	-20	-20	-20	-10	-10	-10	-4	-4	0	0	0
		-170	-100	-48	-60	-32	-38	-50	-18	-22	-28	-9	-12	-5	-8	-12
6	10	-150	-80	-40	-40	-25	-25	-25	-13	-13	-13	-5	-5	0	0	0
		-186	-116	-62	-76	-40	-47	-61	-22	-28	-35	-11	-14	-6	-9	-15
10	14	-150	-95	-50	-50	-32	-32	-32	-16	-16	-16	-6	-6	0	0	0
		-193	-138	-77	-93	-50	-59	-75	-27	-34	-43	-14	-17	-8	-11	-18
18	24	-160	-110	-65	-65	-40	-40	-40	-20	-20	-20	-7	-7	0	0	0
		-212	-162	-98	-117	-61	-73	-92	-33	-41	-53	-16	-20	-9	-13	-21
30	40	-170	-120	-80	-80	-50	-50	-50	-25	-25	-25	-9	-9	0	0	0
		-232	-182													
40	50	-180	-130	-119	-142	-75	-89	-112	-41	-50	-64	-20	-25	-11	-16	-25
		-242	-192													
50	65	-190	-140	-100	-100	-60	-60	-60	-30	-30	-30	-10	-10	0	0	0
		-264	-214													
65	80	-200	-150	-146	-174	-90	-106	-134	-49	-60	-76	-23	-29	-13	-19	-30
		-274	-224													
80	100	-220	-170	-120	-120	-72	-72	-72	-36	-36	-36	-12	-12	0	0	0
		-307	-257													
100	120	-240	-180	-174	-207	-107	-126	-159	-58	-71	-90	-27	-34	-15	-22	-35
		-327	-267													
120	140	-260	-200													
		-360	-300													
140	160	-280	-210	-145	-145	-85	-85	-85	-43	-43	-43	-14	-14	0	0	0
		-380	-310													
160	180	-310	-230	-208	-245	-125	-148	-185	-68	-83	-106	-32	-39	-18	-25	-40
		-410	-330													
180	200	-340	-240													
		-455	-355													
200	225	-380	-260	-170	-170	-100	-100	-100	-50	-50	-50	-15	-15	0	0	0
		-495	-375													
225	250	-420	-280	-242	-285	-146	-172	-215	-79	-96	-122	-35	-44	-20	-29	-46
		-535	-395													
250	280	-480	-300	-190	-190	-110	-110	-110	-56	-56	-56	-17	-17	0	0	0
		-610	-430													
280	315	-540	-330	-271	-320	-162	-191	-240	-88	-108	-137	-40	-49	-23	-32	-52
		-670	-460													
315	355	-600	-360	-210	-210	-125	-125	-125	-62	-62	-62	-18	-18	0	0	0
		-740	-500													
355	400	-680	-400	-299	-350	-182	-214	-265	-98	-119	-151	-43	-54	-25	-36	-57
		-820	-540													
400	450	-760	-440	-230	-230	-135	-135	-135	-68	-68	-68	-20	-20	0	0	0
		-915	-595													
450	500	-840	-480	-327	-385	-198	-232	-290	-108	-131	-165	-47	-60	-27	-40	-63
		-995	-635													

Remarque 1) Les dénominations de la première ligne du tableau représentent les plages de tolérances, les autres lignes du tableau indiquent les valeurs mini et maxi en microns suivant les diamètres indiqués dans la colonne de gauche.

P

DONNÉES TECHNIQUES

Classification des tolérances géométriques des arbres

h8	h9	js5	js6	js7	k5	k6	m5	m6	n6	p6	r6	s6	t6	u6	x6
0 -14	0 -25	± 2	± 3	± 5	+4 0	+6 0	+6 +2	+8 +2	+10 +4	+12 +6	+16 +10	+20 +14	—	+24 +18	+26 +20
0 -18	0 -30	± 2.5	± 4	± 6	+6 +1	+9 +1	+9 +4	+12 +4	+16 +8	+20 +12	+23 +15	+27 +19	—	+31 +23	+36 +28
0 -22	0 -36	± 3	± 4.5	± 7	+7 +1	+10 +1	+12 +6	+15 +6	+19 +10	+24 +15	+28 +19	+32 +23	—	+37 +28	+43 +34
0 -27	0 -43	± 4	± 5.5	± 9	+9 +1	+12 +1	+15 +7	+18 +7	+23 +12	+29 +18	+34 +23	+39 +28	—	+44 +33	+51 +40 +56 +45
0 -33	0 -52	± 4.5	± 6.5	± 10	+11 +2	+15 +2	+17 +8	+21 +8	+28 +15	+35 +22	+41 +28	+48 +35	— +54 +41	+54 +61 +48	+67 +54 +77 +64
0 -39	0 -62	± 5.5	± 8	± 12	+13 +2	+18 +2	+20 +9	+25 +9	+33 +17	+42 +26	+50 +34	+59 +43	+64 +48 +70 +54	+76 +60 +86 +70	—
0 -46	0 -74	± 6.5	± 9.5	± 15	+15 +2	+21 +2	+24 +11	+30 +11	+39 +20	+51 +32	+60 +41 +62 +43	+72 +53 +78 +59	+85 +66 +94 +75	+106 +87 +121 +102	—
0 -54	0 -87	± 7.5	± 11	± 17	+18 +3	+25 +3	+28 +13	+35 +13	+45 +23	+59 +37	+73 +51 +76 +54	+93 +71 +101 +79	+113 +91 +126 +104	+146 +124 +166 +144	—
0 -63	0 -100	± 9	± 12.5	± 20	+21 +3	+28 +3	+33 +15	+40 +15	+52 +27	+68 +43	+88 +63 +90 +65 +93 +68	+117 +92 +125 +100 +133 +108	+147 +122 +159 +134 +171 +146	—	—
0 -72	0 -115	± 10	± 14.5	± 23	+24 +4	+33 +4	+37 +17	+46 +17	+60 +31	+79 +50	+106 +77 +109 +80 +113 +84	+151 +122 +159 +130 +169 +140	—	—	—
0 -81	0 -130	± 11.5	± 16	± 26	+27 +4	+36 +4	+43 +20	+52 +20	+66 +34	+88 +56	+126 +94 +130 +98	—	—	—	—
0 -89	0 -140	± 12.5	± 18	± 28	+29 +4	+40 +4	+46 +21	+57 +21	+73 +37	+98 +62	+144 +108 +150 +114	—	—	—	—
0 -97	0 -155	± 13.5	± 20	± 31	+32 +5	+45 +5	+50 +23	+63 +23	+80 +40	+108 +68	+166 +126 +172 +132	—	—	—	—

SYSTÈME INTERNATIONAL

■ TABLEAUX DE CONVERSION
(Couple de serrage, unité : SI)

● Pression

Pa	kPa	MPa	bar	kgf/cm ²	atm	mmH ₂ O	mmHg ou Torr
1	1×10 ⁻³	1×10 ⁻⁶	1×10 ⁻⁵	1.01972×10 ⁻⁵	9.86923×10 ⁻⁶	1.01972×10 ⁻¹	7.50062×10 ⁻³
1×10 ³	1	1×10 ⁻³	1×10 ⁻²	1.01972×10 ⁻²	9.86923×10 ⁻³	1.01972×10 ²	7.50062
1×10 ⁶	1×10 ³	1	1×10	1.01972×10	9.86923	1.01972×10 ⁵	7.50062×10 ³
1×10 ⁵	1×10 ²	1×10 ⁻¹	1	1.01972	9.86923×10 ⁻¹	1.01972×10 ⁴	7.50062×10 ²
9.80665×10 ⁴	9.80665×10	9.80665×10 ⁻²	9.80665×10 ⁻¹	1	9.67841×10 ⁻¹	1×10 ⁴	7.35559×10 ²
1.01325×10 ⁵	1.01325×10 ²	1.01325×10 ⁻¹	1.01325	1.03323	1	1.03323×10 ⁴	7.60000×10 ²
9.80665	9.80665×10 ⁻³	9.80665×10 ⁻⁶	9.80665×10 ⁻⁵	1×10 ⁻⁴	9.67841×10 ⁻⁵	1	7.35559×10 ⁻²
1.33322×10 ²	1.33322×10 ⁻¹	1.33322×10 ⁻⁴	1.33322×10 ⁻³	1.35951×10 ⁻³	1.31579×10 ⁻³	1.35951×10	1

Remarque 1) 1Pa=1N/m²

● Effort

N	dyn	kgf
1	1×10 ⁵	1.01972×10 ⁻¹
1×10 ⁻⁵	1	1.01972×10 ⁻⁶
9.80665	9.80665×10 ⁵	1

● Fatigue

Pa	MPa or N/mm ²	kgf/mm ²	kgf/cm ²
1	1×10 ⁻⁶	1.01972×10 ⁻⁷	1.01972×10 ⁻⁵
1×10 ⁶	1	1.01972×10 ⁻¹	1.01972×10
9.80665×10 ⁶	9.80665	1	1×10 ²
9.80665×10 ⁴	9.80665×10 ⁻²	1×10 ⁻²	1

Remarque 1) 1Pa=1N/m²

● Travail / Énergie / Calorie

J	kW·h	kgf·m	kcal
1	2.77778×10 ⁻⁷	1.01972×10 ⁻¹	2.38889×10 ⁻⁴
3.600 ×10 ⁶	1	3.67098×10 ⁵	8.6000 ×10 ²
9.80665	2.72407×10 ⁻⁶	1	2.34270×10 ⁻³
4.18605×10 ³	1.16279×10 ⁻³	4.26858×10 ²	1

Remarque 1) 1J=1W·s, 1J=1N·m
1cal=4.18605J
(Par la loi des poids et des mesures)

● Puissance (taux / puissance motrice) / débit calorifique

W	kgf·m/s	PS	kcal/h
1	1.01972×10 ⁻¹	1.35962×10 ⁻³	8.6000 ×10 ⁻¹
9.80665	1	1.33333×10 ⁻²	8.43371
7.355 ×10 ²	7.5 ×10	1	6.32529×10 ²
1.16279	1.18572×10 ⁻¹	1.58095×10 ⁻³	1











Remarque 1) 1W=1J/s, PS:Puissance en chevaux Français.
1PS=0.7355kW
1cal=4.18605J
(Par la loi des poids et des mesures)

P

DONNÉES TECHNIQUES

TYPE D'USURE

PROBLÈMES ET SOLUTIONS

Détériorations		Cause	Solution
Usure en dépouille		<ul style="list-style-type: none"> Nuance trop tendre. Vitesse de coupe trop élevée. Angle de dépouille est faible. Avance extrêmement lente. 	<ul style="list-style-type: none"> Choisir une nuance résistante à l'usure. Réduire vitesse de coupe. Augmentez l'angle de dépouille. Augmenter avance.
Usure en cratère		<ul style="list-style-type: none"> Nuance trop tendre. Vitesse de coupe trop élevée. Avance trop élevée. 	<ul style="list-style-type: none"> Choisir une nuance résistante à l'usure. Réduire vitesse de coupe. Réduire l'avance.
Écaillage		<ul style="list-style-type: none"> Nuance trop dure. Avance trop élevée. Géométrie arête inadaptée. Manque de rigidité, porte-outil. 	<ul style="list-style-type: none"> Choisir une nuance plus tenace. Réduire l'avance. Augmentez le renfort d'arête. (Chanfrein au lieu d'un arrondi.) Utilisez un corps d'outil plus grand.
Écaillage important		<ul style="list-style-type: none"> Nuance trop dure. Avance trop élevée. Géométrie arête inadaptée. Manque de rigidité, porte-outil. 	<ul style="list-style-type: none"> Choisir une nuance plus tenace. Réduire l'avance. Augmentez le renfort d'arête. (Chanfrein au lieu d'un arrondi.) Utilisez un corps d'outil plus grand.
Déformation plastique		<ul style="list-style-type: none"> Nuance trop tendre. Vitesse de coupe trop élevée. Profondeur de coupe et avance trop importantes. Température de coupe trop élevée. 	<ul style="list-style-type: none"> Choisir une nuance résistante à l'usure. Réduire vitesse de coupe. Réduire la profondeur de coupe et l'avance. Nuance avec grande conductivité thermique.
Arête rapportée		<ul style="list-style-type: none"> Faible vitesse de coupe. Manque de coupe. Nuance inappropriée. 	<ul style="list-style-type: none"> Augmentez la vitesse de coupe. (Pour acier au carbone vitesse de coupe 80m/min.) Augmentez l'angle de coupe. Choisir une nuance à faible affinité carbone. (Nuance revêtue, nuance cermet)
Fissuration thermique		<ul style="list-style-type: none"> Dilatation ou contraction due à la température de coupe qui varie. Nuance trop dure. *Spécialement en fraisage. 	<ul style="list-style-type: none"> Sans arrosage. (En cas d'arrosage, augmentez volume et pression) Choisir une nuance plus tenace.
Entailles		<ul style="list-style-type: none"> Surfaces dures, brutes, croûtes... Friction sur la dépouille de l'outil provoquée par des copeaux de forme irrégulière. (ex : en cas de légères vibrations) 	<ul style="list-style-type: none"> Choisir une nuance résistante à l'usure. Augmentez l'angle de coupe, arête plus vive.
Éclatement		<ul style="list-style-type: none"> Arête rapportée. Mauvaise formation copeaux. 	<ul style="list-style-type: none"> Augmentez l'angle de coupe, arête plus vive. Agrandir l'espace à copeaux.
Usure en dépouille et écaillage *Détérioration du PCD		<ul style="list-style-type: none"> Détérioration due au manque de résistance de l'arête de coupe incurvée. 	<ul style="list-style-type: none"> Augmentez le renfort d'arête. Choisir une nuance plus tenace.
Usure en cratère et écaillage *Détérioration du PCD		<ul style="list-style-type: none"> La nuance est trop tendre. Effort de coupe trop élevé causant une forte température à la pointe de l'outil. 	<ul style="list-style-type: none"> Diminuer le renfort d'arête. Choisir une nuance résistante à l'usure.

MATÉRIAUX DE COUPE

Le carbure métallique Wc-Co a été développé en 1923 et amélioré plus tard par l'ajout de TiC et TaC. En 1969 apparaît le revêtement CVD. Le carbure revêtu est depuis très largement utilisé. La base cermet TiC-TiN voit le jour en 1974. Actuellement, "le carbure revêtu pour l'ébauche et le cermet pour la finition" est une tendance vérifiée et bien établie.

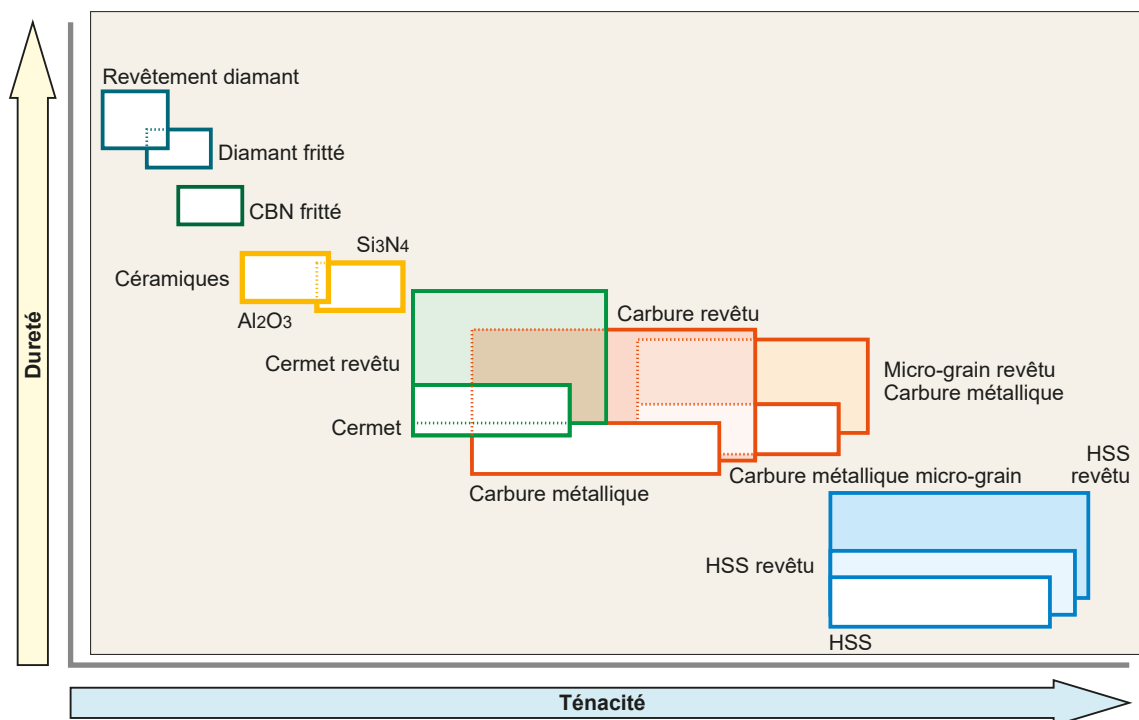

P

DONNÉES TECHNIQUES

CARACTÉRISTIQUES DES NUANCES

Matériaux durs	Dureté (HV)	Dispersion énergie (kcal/g·atom)	Solution dans Fe (%.1250°C)	Conductivité thermique (W/m·k)	Expansion * thermique (x 10 ⁻⁶ /k)	Matériau de coupe
Diamant	>9000	–	Hautement soluble	2100	3.1	Diamant fritté
CBN	>4500	–	–	1300	4.7	CBN fritté
Si ₃ N ₄	1600	–	–	100	3.4	Céramiques
Al ₂ O ₃	2100	-100	≠0	29	7.8	Céramiques Carbure métallique
TiC	3200	-35	< 0.5	21	7.4	Cermet Carbure revêtu
TiN	2500	-50	–	29	9.4	Cermet Carbure revêtu
TaC	1800	-40	0.5	21	6.3	Carbure métallique
WC	2100	-10	7	121	5.2	Carbure métallique

*1W/m·K=2.39×10⁻³cal/cm·sec·°C

CLASSIFICATION DES NUANCES

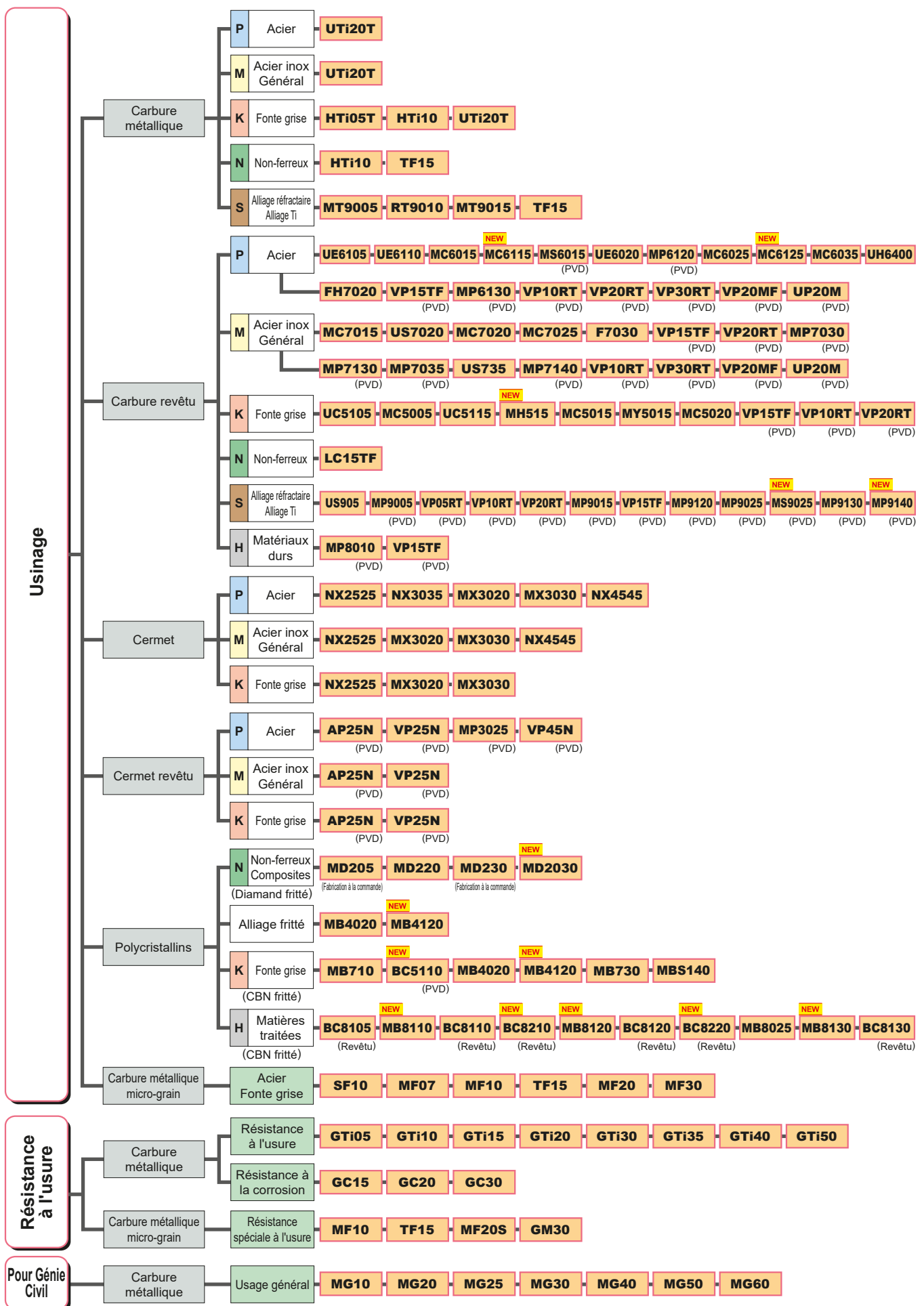

P
DONNÉES TECHNIQUES

TABLEAU DE COMPARAISON DES NUANCES

CARBURE MÉTALLIQUE

Classification	ISO	Mitsubishi	Sandvik	Kennametal	Seco	Iscar	Sumitomo	Tungaloy	Kyocera	Dijet	MOLDINO	
	Symbole	Materials			Tools		Electric					
Tournage	P	P01										
		P10				IC70	ST10P	TH10			WS10	
		P20	UTi20T				IC70 IC50M	ST20E	KS20			EX35
		P30	UTi20T				IC50M IC54	A30 A30N	UX30 KS15F			EX35
		P40					IC54	ST40E	TX40			EX35
	M	M10			KU10 K313 K68	890	IC07	EH510	TH10			WA10B
		M20	UTi20T		KU10 K313 K68	HX 883	IC07 IC08 IC20	EH520	KS20			EX35
		M30	UTi20T				IC08 IC20 IC28	A30 A30N	UX30			EX35
		M40					IC28		TU40			
	K	K01	HTi05T		KU10 K313 K68			H1 H2	KS05F			WH01 WH05
		K10	HTi10		KU10 K313 K68	890	IC20	EH510	TH10	KW10 GW15	KT9	WH10
		K20	UTi20T	H13A	KU10 K313 K68	HX	IC20	G10E H10E EH520	KS15F KS20	GW25	KT9	WH20
		K30	UTi20T			883		G10E H10E				
	N	N01		H10				H1 H2	KS05F	GW05 KW10		
		N10	HTi10	H10 HBA	KU10 K313 K68	890	IC08 IC20	EH510	TH10	KW10 GW15	KT9	WH10
		N20		H10 HBA	KU10 K313 K68	HX KX	IC08 IC20	G10E EH520	KS15F		KT9	WH20
		N30				883						
	S	S01	MT9005							SW05		
		S10	MT9005 RT9010 MT9015	H10A H10F H13A	KU10 K313 K68	HX 883	IC07 IC08	EH510	KS05F TH10	SW10		WH13S
		S20	RT9010 TF15		KU10 K313 K68	883	IC07 IC08	EH520	KS15F KS20	SW25		
S30		TF15										
Fraisage	P	P10										
		P20	UTi20T		K125M		IC50M IC28	A30N			EX35	
		P30	UTi20T	SM30	GX		IC50M IC28	A30N	UX30		EX35	
		P40					IC28				EX35	
	M	M10										
		M20	UTi20T				IC08 IC20	A30N				EX35
		M30	UTi20T	SM30			IC08 IC28	A30N				EX35
		M40					IC28					
	K	K01	HTi05T		K115M,K313							
		K10	HTi10		K115M K313		IC20	G10E	TH10	KW10 GW25	KT9	WH10
		K20	UTi20T	H13A		HX	IC20	G10E		GW25	FZ15	WH20
		K30	UTi20T									

Remarque 1) Le tableau ci-dessus est un extrait de publication à titre indicatif. Nous n'avons pas obtenu l'autorisation expresse de chaque compagnie référencée.

DONNÉES TECHNIQUES

MICROGRAIN

	ISO	Mitsubishi Materials	Sandvik	Kennametal	Seco Tools	Sumitomo Electric	Tungaloy	Kyocera	Dijet	MOLDINO	
	Classification										Symbole
Outils de coupe	Z	Z01	SF10 MF07 MF10	PN90 6UF,H3F 8UF,H6F		F0	F MD05F MD1508		FZ05 FB05 FB10	NM08	
		Z10	HTi10 MF20	H10F		890	XF1 F1 AFU	MD10 MD0508 MD07F	FW30	FZ10 FZ15 FB15	NM10 NM12 NM15
		Z20	TF15 MF30	H15F		890 883	AF0 SF2 AF1	EM10 MD20 G1F		FZ15 FB15 FB20	BRM20 EF20N
		Z30				883	A1 CC			FZ20 FB20	NM25 NM40

CERMET

	ISO	Mitsubishi Materials	Sandvik	Kennametal	Seco Tools	Iscar	Sumitomo Electric	Tungaloy	Kyocera	Dijet	MOLDINO	
	Classification											Symbole
Tournage	P	P01	AP25N* VP25N*			IC20N IC520N*	T1000A	NS520 GT720*	CCX* TN610 PV710* PV30*			
		P10	NX2525 AP25N* VP25N*	CT5015 GC1525*	KT315 KT125	TP1020 TP1030* CM CMP*	IC20N IC520N* IC530N*	T1500A T1500Z*	NS520 NS9530 GT9530* AT9530*	CCX* TN60 TN610 PV710* TN620 PV720*	CX75	CZ25*
		P20	NX2525 AP25N* VP25N* NX3035 MP3025*	GC1525*	KT325 KT1120 KT5020*	TP1020 TP1030*	IC20N IC520N* IC30N IC530N* IC75T	T1500A T1500Z* T2500A T2500Z* T3000Z*	NS9530 GT9530* AT9530*	TN60 TN620 PV720* TN6020	CX75 PX90*	CH550
		P30	MP3025* VP45N*				IC75T	T3000Z*		PV730* PV90*	PX90*	
	M	M10	NX2525 AP25N* VP25N*	GC1525*	KT125	TP1020 TP1030* CM CMP*		T1000A T1500Z*		TN60 TN620 PV720* TN6020		CZ25*
		M20	NX2525 AP25N* VP25N*					T1500A T1500Z*		TN90 TN6020 TN620 PV720* PV90*		CH550
		M30								PV730*		
	K	K01	NX2525 AP25N*					T1000A	NS520 GT720*	CCX* PV7005*		
		K10	NX2525 AP25N*	CT5015	KT325 KT125				NS520 NS9530 GT9530*	CCX* PV7005* TN60		CZ25*
		K20	NX2525 AP25N*									CH550
Fraisage	P	P10	NX2525		C15M	IC30N			TN620M TN60	CX75	MZ1000*	
		P20	MX3020 NX2525	CT530	KT530M HT7 KT605M	C15M MP1020	IC30N	T250A T2500A		TN100M TN620M TN60	CX75 CX90	CH550 CH7030 MZ1000*
		P30	MX3030 NX4545				IC30N	T4500A	NS740		CX90	CH7035
	M	M10	NX2525				IC30N			TN60		
		M20	MX3020 NX2525	CT530	KT530M HT7 KT605M	C15M	IC30N	T250A T2500A		TN100M	CX75	
		M30	MX3030 NX4545					T4500A				
	K	K01										
		K10	NX2525							TN60	CX75	
		K20	NX2525		KT530M HT7						CX75	

*Cermet revêtu

Remarque 1) Le tableau ci-dessus est un extrait de publication à titre indicatif. Nous n'avons pas obtenu l'autorisation expresse de chaque compagnie référencée.

P

DONNÉES TECHNIQUES

TABLEAU DE COMPARAISON DES NUANCES

NUANCES REVÊTUES CVD

Classification	ISO	Mitsubishi	Sandvik	Kennametal	Seco	Iscar	Sumitomo	Tungaloy	Kyocera	Dijet	MOLDINO			
	Symbole	Materials			Tools		Electric							
P	P	P01	MC6115 UE6105	GC4305 GC4205 GC4415	KCP05B KCP05 KC9105	TP0501 TP0500 TP1501 TP1500	IC9150 IC8150 IC428	AC810P AC700G	T9105 T9025	CA510 CA5505	JC110V	HG8010		
		P10	MC6115 UE6105 MC6015 UE6110 MY5015	GC4315 GC4215 GC4325 GC4415	KCP10B KCP10 KCP25 KC9110	TP1501 TP1500 TP2501 TP2500	IC9150 IC8150 IC8250	AC810P AC700G AC820P AC2000 AC8015P	T9105 T9115 T9215	CA510 CA5505 CA515 CA5515	JC110V JC215V	HG8010 HG8025 GM8020		
		P20	MC6115 MC6015 UE6110 MC6125 MC6025 UE6020 MY5015	GC4315 GC4215 GC4325 GC4225 GC4425	KCP25B KCP30B KCP25 KC9125	TP2501 TP2500	IC8250 IC9250 IC8350	AC820P AC2000 AC8025P AC830P	T9115 T9125 T9215 T9225	CA025P CA515 CA5515 CA525 CA5525 CR9025	JC110V JC215V	HG8025 GM8020 GM25		
		P30	MC6125 MC6025 UE6020 MC6035 UH6400	GC4325 GC4335 GC4225 GC4235 GC4425	KCP30B KCP30	TP3501 TP3500 TP3000	IC8350 IC9250 IC9350	AC8035P AC830P AC630M	T9125 T9135 T9225 T9235	CA025P CA525 CA5525 CA530 CA5535 CR9025	JC215V JC325V	GM25 GM8035		
		P40	MC6035 UH6400	GC4235 GC4335	KCP40 KCP40B KC9140 KC9240	TP3501 TP3500 TP3000	IC9350	AC8035P AC630M	T9135 T9035 T9235	CA530 CA5535	JC325V	GM8035 GX30		
	M	M10	MC7015 US7020	GC2015 GC2220	KCM15B KCM15	TM1501 TM2000	IC6015 IC8250	AC610M AC6020M	T6120 T9215	CA6515	JX605X JC110V			
		M20	MC7015 US7020 MC7025	GC2015 GC2220	KCM15 KCM25B KCP40B	TM2000 TM2501	IC6015	AC6020M AC610M AC6030M AC630M	T6120 T9215	CA6515 CA6525	JC110V	HG8025 GM25		
		M30	MC7025 US735	GC2025	KCM25 KCM35B KCP40	TM4000 TM3501	IC6025	AC6030M AC630M	T6130	CA6525	JX525X	GM8035 GX30		
		M40	US735	GC2025	KCM35B KCM35	TM4000 TM3501	IC6025	AC6030M AC630M			JX525X	GX30		
	K	K01	MC5005 UC5105	GC3205 GC3210	KCK05B KCK05	TK0501 TH1500	IC5005	AC405K AC410K AC4010K	T505 T515 T5105	CA4505 CA4010 CA310	JC050W JC105V	HX3505		
		K10	MC5015 MH515 UC5115 MY5015	GC3205 GC3210	KCK15B KCK15 KCK20 KC9315 KCK20B	TK0501 TK1501	IC5005 IC5010 IC428	AC405K AC4010K AC410K AC4015K AC415K	T515 T5115	CA315 CA4515 CA4010 CA4115	JC108W JC050W JC105V JC110V	HX3515 HG8010		
		K20	MC5015 MH515 UC5115 UE6110 MY5015	GC3225	KCK20B KCK20 KCPK05	TK1501	IC5010 IC8150	AC4015K AC415K AC420K AC8025P	T5115 T5125	CA320 CA4515 CA4115 CA4120	JC108W JC110V JC215V	HG8025 GM8020		
		K30	UE6110	GC3225	KCPK05			AC8025P	T5125		JC215	HG8025 GM8020		
	S	S01	US905	S05F S205						CA6515 CA6525 CA6535		HS9105 HS9115		
	Fraisage	P	P10				MP1501	IC5400	ACP2000 XCU2500 ACP100			JC730U		
			P20	F7030 MC7020	GC4220		MP1501 MP2501 T25M	IC5500	ACP2000 ACP3000 XCU2500 ACP100	T3130 T3225		JC730U JC835S	GX2140 GF30	
			P30	F7030 MC7020	GC4330 GC4230	KCPK30 KC930M	MP1501 MP2501 TM25 T350	IC5500	ACP3000 XCU2500 ACP100	T3130 T3225		JC835S JC730U	GX2140 GX2160 GF30	
			P40		GC4340 GC4240	KC935M KC530M	MM4500 T350M						GX2030 GX2160	
		M	M10							XCU2500			JC730U	
			M20	F7030 MC7020		KC925M	MP2501 MS2500 T25M T350M		ACP100 ACM200 XCU2500	T3130 T3225	CA6535	JC730U JC835S	AX2040 GX2140	
M30			F7030 FC7020 MC7020	GC2040	KC930M	MP2501 T25M T350M		ACP100 XCU2500 ACM200	T3130 T3225	CA6535	JC730U JC835S	AX2040 GX2140 GX2160 GX30		
M40					KC930M KC935M	MM4500 T350M						GX2160		
K		K01												
		K10	MC5020					XCK2000 ACK200	T1215 T1115	CA420M	JC605W	GX2120		
		K20	MC5020	GC3220 GC3330 K20W	KC915M	MP1501	IC5100	ACK200 XCK2500 XCK2000 ACK200	T1115		JC610 JC605W JC608X	GX2120		
		K30		GC3330 GC3040	KC920M KC925M KCPK30 KC930M KC935M	MP1501	IC5100 DT7150				JC610			

DONNÉES TECHNIQUES

P

Tournage

Fraisage

Remarque 1) Le tableau ci-dessus est un extrait de publication à titre indicatif. Nous n'avons pas obtenu l'autorisation expresse de chaque compagnie référencée.

NUANCES REVÊTUES PVD

Classification	ISO	Mitsubishi	Sandvik	Kennametal	Seco	Iscar	Sumitomo	Tungaloy	Kyocera	Dijet	MOLDINO	
	Symbole	Materials			Tools		Electric					
Tournage	P	P01							PR1005			
		P10	VP10MF MS6015	GC1125	KCU10 KC5010 KC5510 KU10T	CP200 TS2000	IC250 IC507 IC570 IC807 IC907 IC908		AH710 SH725	PR1005 PR1705 PR930 PR1025 PR1115 PR1225 PR1425 PR1725		
		P20	VP10RT VP20RT VP15TF VP20MF MS6015	GC1125 GC15	KCU10 KC5025 KC5525 KU25T	TS2500	IC1007 IC250 IC308 IC507 IC807 IC808 IC907 IC908 IC1008 IC1028 IC3028		AH710 AH725 AH120 SH730 GH730 GH130 SH725	PR930 PR1025 PR1725 PR1115 PR1225 PR1425 PR1535		IP2000
		P30	VP10RT VP20RT VP15TF VP20MF	GC1125	KCU25 KC5525 KU25T	CP500	IC228 IC250 IC328 IC330 IC354 IC528 IC1008 IC1028 IC3028		AH725 AH120 SH730 GH730 GH130 AH740 J740 SH725 AH7025	PR1025 PR1725 PR1225 PR1425 PR1535 PR1625		IP3000
		P40				CP500 CP600	IC228 IC328 IC528 IC928 IC1008 IC1028 IC3028		AH740 J740	PR1535		
	M	M01										
		M10	VP10MF MS6015	GC1115 GC15 GC1105	KCU10 KC5010 KC5510	CP200 TS2000	IC354 IC507 IC520 IC807 IC907 IC1007 IC5080T		AC8005 AH710 SH725	PR1025 PR1225 PR1425 PR1725	JC5003 JC8015	IP050S
		M20	VP10RT VP20RT VP15TF VP20MF MS9025	GC1115 GC15 GC1125	KCU10 KC5010 KC5510	TS2500 CP500	IC354 IC808 IC908 IC1008 IC1028 IC3028 IC5080T	AC520U AC5015S	AH710 AH725 AH120 SH730 GH730 GH130 GH330 AH630 SH725 AH8015 AH7025	PR1025 PR1125 PR1225 PR1425 PR915 PR930 PR1535 PR1725	JC5003 JC5015 JC8015 JC5118	IP100S
		M30	VP10RT VP20RT VP15TF VP20MF MP7035	GC1125 GC2035	KCU25 KC5525	CP500 CP600 TTP2050	IC228 IC250 IC328 IC330 IC1008 IC1028 IC9080T	AC520U AC530U AC1030U AC6040M AC5025S	GH330 AH725 AH120 SH730 GH730 GH130 J740 AH645 SH725	PR1125 PR1725 PR1425 PR1535	JC5015 JC8015 JC5118	
		M40	MP7035	GC2035			IC328 IC928 IC1008 IC1028 IC3028 IC9080T	AC530U AC6040M	J740	PR1535	JC5118	
	K	K01										
		K10		GC15	KCU10 KC5010 KC5510	CP200 TS2000	IC350 IC910 IC1008	AC510U	GH110 AH110 AH710			
		K20	VP10RT VP20RT VP15TF		KCU15 KCU25	CP200 TS2000 TS2500	IC228 IC350 IC808 IC830 IC908 IC1007 IC1008		GH110 AH7025 AH110 AH710 AH725 AH120 GH730 GH130			
		K30	VP10RT VP20RT VP15TF		KCU25 KC5525	CP500	IC228 IC350 IC808 IC830 IC908 IC928 IC1007 IC1008		AH725 AH120 GH730 GH130			
	S	S01	MP9005 VP05RT			TH1000	IC507 IC804 IC807 IC907 IC5080T	AC5005S	AH905 AH8005	PR005S PR1305	JC5003 JC8015	JP9105
		S10	MP9005 MP9015 VP10RT	GC1105 GC15	KCU10 KC5010 KC5410 KC5510	CP200 CP250 TS2000 TS2050 TS2500 TH1000	IC507 IC806 IC807 IC903 IC5080T	AC510U AC5015S	AH905 SH730 AH110 AH8005 AH120	PR005S PR015S PR1310	JC5003 JC5015 JC8015	JP9115
		S20	MP9015 MT9015	GC1125	KCU10 KCU25 KC5025 KC5525	TS2500 CP500	IC228 IC300 IC328 IC808 IC908 IC928 IC3028 IC806 IC9080T	AC510U AC520U AC5025S	AH120 AH725 AH8015	PR015S PR1125 PR1325	JC5015 JC8015 JC5118	
		S30	MS9025 MP9025 VP15TF VP20RT	GC1125	KC5525	CP600	IC928 IC830	AC1030U	AH725 AH7025	PR1125 PR1535	JC5118	
	Fraisage	P	P01				IC903				JC8003	ATH80D ATH08M TH308 PN208 JP4105 PN15M
			P10		GC1010 GC1130	KC505M KC715M KC510M KC515M		IC250 IC350 IC808 IC810 IC900 IC903 IC908 IC910 IC950	ACU2500 ACP200		PR830 PR1225	JC8003 JC8015 JC5015 JC5118
P20			MP6120 VP15TF	GC1010 GC1030 GC1130 GC2030	KC522M KC525M KC527M KC610M KC620M KC635M KC715M KC720M KC730M KTPK20	F25M MP3000	IC250 IC300 IC328 IC330 IC350 IC808 IC810 IC830 IC900 IC908 IC910 IC928 IC950 IC1008	ACU2500 ACP200	AH3225 AH725 AH120 GH330 AH330 AH9130 AH6030	PR830 PR1225 PR1230 PR1525	JC5015 JC5040 JC6235 JC8015 JC5118 JC6235 JC7560P JC8118P	CY9020 JP4120 CY150

P

DONNÉES TECHNIQUES

Remarque 1) Le tableau ci-dessus est un extrait de publication à titre indicatif. Nous n'avons pas obtenu l'autorisation expresse de chaque compagnie référencée.

TABLEAU DE COMPARAISON DES NUANCES

NUANCES REVÊTUES PVD

Classification	ISO	Mitsubishi	Sandvik	Kennametal	Seco	Iscar	Sumitomo	Tungaloy	Kyocera	Dijet	MOLDINO	
	Symbole	Materials			Tools		Electric					
P	P30	MP6120 VP15TF MP6130 VP30RT	GC1010 GC1030 GC2030 GC1130	KC735M KC725M KC530M KC537M KCPM40	F25M MP3000 F30M MP2050	IC250 IC300 IC328 IC330 IC350 IC830 IC845 IC900 IC928 IC950 IC1008	ACU2500 ACP200 ACP300	AH725 AH120 AH130 AH140 GH130 AH730 AH3035 AH6030 AH3225 AH9130	PR1230 PR1525	JC6235 JC7560 JC8050 JC7560P JC5015 JC8118 JC5040 JC8118P JC8015 JC5118	JS4045 CY250 CY250V CY25 HC844	
		P40	VP30RT	GC2030 GC1030 GC1130	KC735M KC537M KCPM40	F40M T60M	IC300 IC328 IC330 IC830 IC928 IC1008	ACP300	AH140 AH3035	PR1525	JC6235 JC7560 JC8050 JC7560P JC5040 JC8118 JC5118 JC8118P JC5118	JS4060 PTH30E PTH40H JX1060 JS4060
	M01					IC907					PN08M PN208	
	M10		GC1025 GC1030 GC1010 GC1130	KC715M KC515M		IC903	ACU2500 ACM100		PR1225		PN15M PN215	
	M20	VP15TF MP7130 MP7030 VP20RT	GC1025 GC1030 GC1040 GC2030 S30T	KC610M KC635M KC730M KC720M KC522M KC525M KCPM40 KTPK20	F25M MP3000	IC250 IC300 IC808 IC830 IC900 IC908 IC928 IC1008	ACU2500 ACP200	AH725 AH120 GH330 AH330 GH110 AH6030 AH9130	PR1025 PR1225	JC5015 JC5118 JC8015	JP4120	
	M30	VP15TF MP7130 MP7030 VP20RT MP7140 VP30RT	S30T GC1040 GC2030	KC537M KC725M KC735M KCPM40 KC530M	F30M F40M MP3000 MP2050	IC250 IC300 IC328 IC330 IC380 IC830 IC882 IC928 IC1008	ACP200 ACP300 ACM300	AH120 AH725 AH130 AH140 GH130 AH730 GH340 AH9130 AH3135 AH4035	PR830 PR1225 PR1525 PR1535	JC5015 JC7560 JC8015 JC7560P JC8050 JC8118 JC5118 JC8118P	JS4045 CY250 HC844	
	M40	MP7140 VP30RT			F40M MP2050	IC250 IC300 IC328 IC330 IC882 IC1008	ACP300 ACM300	AH140 AH3135 AH4035	PR1525 PR1535	JC5015 JC7560 JC5118 JC7560P JC8050 JC8118 JC8118P	PTH30E PTH40H JM4160	
	K	K01	MP8010						AH110 GH110 AH330		JC8003	ATH80D ATH08M TH308
		K10	MP8010	GC1010	KC514M KC515M KC527M KC635M	MK2050	IC350 IC810 IC830 IC900 IC910 IC928 IC950 IC380 IC1008	ACU2500 ACK3000	AH110 GH110 AH725 AH120 GH130 AH330	PR1210 PR1510	JC8015	ATH10E TH315 CY100H
		K20	VP15TF VP20RT	GC1010 GC1020	KTPK20 KC514M KC610M KC520M KC620M KC524M	MK2000 MK2050	IC350 IC808 IC810 IC830 IC900 IC908 IC910 IC928 IC950 IC1008	ACU2500 ACK300 ACK3000	GH130 AH9130 AH9030	PR1210 PR1510	JC5015 JC8015 JC6235	CY150 JP4120 CY9020 PTH13S
		K30	VP15TF VP20RT	GC1020	KC522M KC725M KC524M KC735M KC537M	MK2050	IC350 IC808 IC830 IC908 IC928 IC950 IC1008	ACK300 ACK3000			JC6235 JC5015 JC8015 JC8118 JC8118P	CY250 JS4045
	S	S01					IC907 IC908 IC808 IC903		AH110 AH710	PR1210	JC8003 JC8015 JC5118	PN08M PN208
		S10	MP9120 VP15TF	GC1130 GC1010 GC1030 GC2030	KC510M	MS2050	IC903 IC907 IC908 IC840 IC910 IC808	EH520Z EH20Z ACM100	AH120 AH725	PR1210	JC8003 JC5015 JC8015 JC5118	JS1025 JP4120
		S20	MP9120 VP15TF MP9130 MP9030	S30T GC2030 GC1030 GC1130	KC522M KC525M KCSM30 KCPM40	MS2050 MP2050	IC300 IC908 IC808 IC900 IC830 IC928 IC328 IC330 IC840 IC882 IC380	EH520Z EH20Z ACK300 ACP300	AH725 AH6030 AH130	PR1535	JC8015 JC5015 JC8050 JC5118	PTH30H
		S30		GC2030 GC1040	KC725M KCPM40	MS2050 F40M KCSM40	IC830 IC882 IC928	ACP300 ACM300	AH3135	PR1535	JC8050 JC7560 JC5118	JM4160
	H	H01	MP8010 VP05HT				IC903				JC8003 DH103 JC8008 DH102	
H10		VP15TF VP10H	GC1130 GC1010 GC1030	KC505M KC510M	MH1000 F15M	IC900 IC808 IC907 IC905				JC8003 JC8008 JC8015 JC5118 JC8118P	JP4105 TH303 TH308 PTH08M ATH08M ATH80D	
H20		VP15TF	GC1030 GC1130		F15M	IC900 IC808 IC908 IC380 IC1008		AH3135		JC8015 JC5118 JC8118P	JP4115 TH315	
H30					MP3000 F30M	IC380 IC900 IC1008		AH3135			JP4120	

Remarque 1) Le tableau ci-dessus est un extrait de publication à titre indicatif. Nous n'avons pas obtenu l'autorisation expresse de chaque compagnie référencée.

CBN

	ISO		Mitsubishi Materials	Sandvik	Seco Tools	Sumitomo Electric	Tungaloy	Kyocera	Dijet
	Classification	Symbole							
Tournage	H	H01	BC8105 BC8110 MB8110	CB7105	CBN060K	BNC100 BNX10 BN1000 BNC2010	BXM10 BX310	KBN05M KBN10M KBN510	
		H10	BC8110 MBC020 BC8120 BC8220 MB8025 MB8110 MB8120	CB7115 CB7015	CBN010	BNC160 BNX20 BN2000 BNC2020	BXM10 BX330 BX530	KBN05M KBN25M KBN525	JBN300
		H20	MBC020 BC8120 BC8220 MB8025 MB8120	CB7125 CB7025 CB20	CBN150 CBN160C	BNC200 BNX25 BN250 BNC2020	BXM20 BXA20 BX360	KBN525 KBN05M KBN25M	JBN245
		H30	BC8130 MB8130	CB7135 CB7525	CBN150 CBN160C	BNC300 BN350	BXC50 BX380	KBN35M	
	S	S01	MB730 MB8025		CBN170	BN700 BN7000	M714B		
		S10				BNS8125	BX470, BX480		
		S20							
		S30							
	K	K01	MB710 BC5110 MB5015			BN500 BNC500	BX870 BX930 BX910		
		K10	MB730 MB4020 MB4120	CB7525		BN700 BN7500 BN7000	BX470 BX480	KBN60M	JBN795
		K20	MB730 MB4020 MB4120		CBN200	BN700 BN7000	BX480	KBN60M	JBN500
		K30	BC5030	CB7925	CBN300 CBN400C CBN500	BNS800 BNC8115, BNC8125	BX90S BXC90	KBN900	
		Alliage fritté	MB4020 MB4120		CBN200	BN7500 BN7000 BNC7115	BX470 BX480	KBN570 KBN70M	

P

DONNÉES TECHNIQUES

PCD

	ISO		Mitsubishi Materials	Sandvik	Seco Tools	Sumitomo Electric	Tungaloy	Kyocera	Dijet
	Classification	Symbole							
Tournage	N	N01	MD205	CD05	PCD05	DA90	DX180 DX160	KPD001	JDA30 JDA735
		N10	MD220	CD10	PCD10	DA150	DX140	KPD010	
		N20	MD220		PCD20	DA2200	DX120		JDA715
		N30	MD230 MD2030		PCD30 PCD30M	DA1000	DX110	KPD230	JDA10

Remarque 1) Le tableau ci-dessus est un extrait de publication à titre indicatif. Nous n'avons pas obtenu l'autorisation expresse de chaque compagnie référencée.

Notes

A series of horizontal dashed lines for writing notes.

INDEX

INDEX RÉFÉRENCES OUTILS

A.....	2
B.....	2
C.....	2
D.....	2
E.....	2
F.....	2
G.....	3
H.....	3
J.....	3
K.....	3
L.....	3
M.....	3
N.....	4
O.....	4
P.....	4
Q.....	4
R.....	4
S.....	4
T.....	5
U.....	5
V.....	5
W.....	5
X.....	6
Z.....	6
NUMÉROS • AUTRES.....	6



INDEX REFERENCES OUTILS

Référence	NOMS DES PRODUITS	Page	Référence	NOMS DES PRODUITS	Page
A			B		
AEMW○○○○○○ER.....	Plaquette (Pour fraise BAE)	L023	BCP○○○	Goupille	N014
AHX440S-○○○○○○OR.....	Fraise à surfacer AHX440S	K034	BOES101	Vis	N009
AHX475S-○○○○○○OR.....	Fraise à surfacer AHX475S	K038	BPT322	Assise	N011
AHX640S-○○○○○○OR.....	Fraise à surfacer AHX640S	K041	BRP○NR○○○○M○○	Fraise BRP	K190
AHX640W-○○○○○○R/L.....	Fraise à surfacer AHX640W	K048	BRP6P/N-○○○○○○R.....	Fraise BRP	K190
AJS○○○○T○○	Vis de fixation	N003	BRS○○○	Vis de fixation	N003
AJX○○-○○○○OR.....	Fraise AJX	K180	C		
AJX○○R○○AM○○	Fraise AJX	K182	CA○○○	Bride de serrage	N015
AJX○○R○○SA○○S/L/ES/EL.....	Fraise AJX	K183, K184	CAS51T	Vis de fixation	N003
AMS○	Bride de serrage	N015	CBS○	Brise-copeaux	N017
AOGT○○○○○○PEFR-GM.....	Plaquette (Pour fraise APX3000)	K137, K149, L022	CBS○○	Brise-copeaux	N017
AOMT○○○○○○PEER-○	Plaquette (Pour fraise APX3000)	K137, K144, K149, L022	CBT○	Brise-copeaux	N017
APGT○○○○PDFR-G2.....	Plaquette (Pour fraise BAP300*400)	L023	CCK○○	Bride de serrage	N015
APMT○○○○PDER-H○	Plaquette (Pour fraise BAP300*400/SRM2)	K233, 229, L023	CCMX○○○○○○EN-○	Plaquette (Pour fraise DCCC)	K201, L024
APMT○○○○PDER-M○	Plaquette (Pour fraise BAP300*400/SRM2)	K233, K249, L023	CCP○○	Goupille	N014
APX3K-○○○A○○A○○RA.....	Fraise APX3000	K148	CCTC1.....	Bride de serrage	N015
APX3KR○○○○S○○○○○○A.....	Fraise APX3000	K147	CESPR○○○○S○○	Fraise CESP	K230
APX3000-○○○A○○RA.....	Fraise APX3000	K135	CFSPR○○○○S○○	Fraise CFSP	K230
APX3000R○○○○M○○A/A○○	Fraise APX3000	K136	CGSPR○○○○S○○	Fraise CGSP	K230
APX3000R○○○○SA○○SA/LA/ELA.....	Fraise APX3000	K134	CK○○○	Bride de serrage	N015
APX3000R○○○○WA○○○A.....	Fraise APX3000	K133	CKW6	Bride de serrage	N016
APX4K-○○○A○○A○○RA.....	Fraise APX4000	K152	CPMT○○○○ZPEN-M○	Plaquette (Pour fraise PMR)	K237, L024
APX4KR○○○○WA○○○○○○A.....	Fraise APX4000	K151	CS○○	Assise	N011
APX4000-○○○A○○RA.....	Fraise APX4000	K142	CSF401260T	Vis de fixation	N003
APX4000R○○○○M○○A○○	Fraise APX4000	K143	CS○○○T	Vis de fixation	N003
APX4000R○○○○SA○○SA/LA/ELA.....	Fraise APX4000	J089	CS○○○○○T	Vis de fixation	N003
APX4000R○○○○WA○○SA/LA/ELA.....	Fraise APX4000	K140	CT○○	Assise	N011
AQXR○○○○A/N○○S/L.....	Fraise AQX	K172, K173	CT32T1.....	Assise	N012
AQXR○○○○M○○A○○	Fraise AQX	K174	D		
ARP○P-○○○○○○AR.....	Fraise à surfacer ARP	K238	DCCCR○○○○S○○	Fraise DCCC	K200
ARP○PR○○○○AM○○○○	Fraise ARP	K240	DCK○○○○	Bride de serrage	N016
ARP○PR○○○○SA○○L/M.....	Fraise ARP	K239	DCSVN32	Assise	N011
ASPX4-○○○A○○A○○RA○○	Fraise ASPX	K208	DC○○○○T.....	Vis de fixation	N003
ASPX4R0805H○○○○A127SA.....	Fraise ASPX	K209	DKS○	Vis de fixation	N003
ASX400-○○○○○○OR.....	Fraise à surfacer ASX400	K068	E		
ASX400R○○○○M16.....	Fraise ASX400	K069	EGS○○○○○	Vis de fixation	N004
ASX400R○○○○S32.....	Fraise ASX400	K069	ESS42	Assise	N011
ASX445-○○○○○○R/L.....	Fraise à surfacer ASX445	K026	EST○○	Assise	N011
ASX445R○○○○S32.....	Fraise à surfacer ASX445	K027	F		
AXD4000A-050A04RD/E.....	Fraise AXD4000A	K162	FC400890T.....	Vis de fixation	N004
AXD4000-○○○○○○RA/B.....	Fraise AXD4000	K155	FMAX-○○○A○○R.....	Fraise à surfacer FMAX	K052
AXD4000R○○○○SA○○○A/B.....	Fraise AXD4000	K156	FMAX-○○○B○○R.....	Fraise à surfacer FMAX	K053
AXD7000-○○○○○○RA/B.....	Fraise à surfacer AXD7000	K166	FMAXR1○○○○○CLW.....	Fraise à surfacer FMAX	K051
AXD7000R○○○○○A-H63A.....	Fraise AXD7000	K167			
AXD7000R○○○○SA○○SA/B.....	Fraise AXD7000	K166			

Référence	NOMS DES PRODUITS	Page	Référence	NOMS DES PRODUITS	Page
G			LLCL000	Levier de fixation	N014
GOER14000XFR2	Plaquette (Pour fraise FMAX)	K054, L051	LLCL00S	Levier de fixation	N014
GOER14008PXFR2-8	Plaquette (Pour fraise FMAX)	K054, L051	LLCS000	Vis de fixation	N005
H			LLCS000S	Vis de fixation	N005
HBH00000	Vis de fixation	N002	LLP00	Goupille	N014
HBHA00000	Vis de fixation	N002	LLR0	Vis de pré-réglage	N004
HDS00000	Vis de fixation	N009	LLSCN00	Assise	N011
HFF06015	Vis de fixation	N004	LLSCN0TO	Assise	N011
HFF08000H	Vis de fixation	N009	LLSCP00	Assise	N011
HKY00D	Entraîneur	N002	LLSDN00	Assise	N011
HKY00F	Clé drapeau	N002	LLSDP42	Assise	N011
HKY00L	Clé	N002	LLSRN000	Assise	N011
HKY00R	Clé	N002	LLSSN00	Assise	N011
HKY00T	Clé	N002	LLSSP42	Assise	N011
HKY00W	Clé drapeau	N002	LLSTE32	Assise	N012
HS00	Vis de fixation	N004	LLSTN00	Assise	N012
HSC00000	Vis de fixation	N002, N009	LLSTP00	Assise	N012
HSC00000H	Vis	N009	LLSWN000	Assise	N012
HSCX00000H	Vis	N009	LLSWN0TO	Assise	N012
HSP05008C	Vis de fixation	N004	LLSWP00	Assise	N012
HSS00000	Vis de fixation	N002	LNGU0000000PNE00	Plaquette pour fraises 3 tailles	L027
HY0	Vis d'entretoise	N004	LOGU00000000PNOR00	Plaquette (Pour fraise VPX200/VPX300)	K090, K104, K117, K126, L026, L027
HY-A1	Vis d'entretoise	N004	LS0	Vis de fixation	N005
HY-V1	Vis d'entretoise	N004	LS00	Vis de fixation	N005
J			LS00T	Vis de fixation	N005
JDMT00000000ZDOR00	Plaquette (Pour fraise AJAX/PMC)	K185, L024	LS0000T	Vis de fixation	N005
JDMW00000000ZDSR-FT	Plaquette (Pour fraise AJAX)	K185, L024	LS10TS	Vis de fixation	N005
JOMT00000000ZZOR00	Plaquette (Pour fraise AJAX/PMC)	K185, L024	LS24H	Vis de fixation	N005
JOMU00000000ZZER00	Plaquette (Pour fraise WJX)	K074, K081, L025	M		
JOMW00000000ZZSR-FT	Plaquette (Pour fraise AJAX/PMC)	K185, L024	MBA000000H	Vis de fixation	N009
JPGX00000000PPER-JM	Plaquette (Pour fraise ASPX)	K210, L025	MGS6	Vis de fixation	N005
JPMT060204-E	Plaquette (Pour fraise TAB/CBJP)	L025	MHK5NR/L	Bride de serrage	N016
JPMX0000000000	Plaquette (Pour fraise SPX)	K205, L025	MHS000R/L	Assise	N012
JSS0	Vis de fixation	N004	MHT1	Vis de fixation	N005
K			MK1K	Anti-grippant	N018
KGC1	Bride de serrage	N016	MK1KS	Anti-grippant	N018
KS0	Vis axiale	N004	MLCP42	Assise	N012
KS00	Vis	N004	MLDP42	Assise	N012
KSN0	Vis de fixation	N010	MLSP42	Assise	N012
KSN3	Écrou de réglage micrométrique	N010	MLTP32	Assise	N012
KS0S	Vis de pré-réglage	N004	MPMT00000000	Plaquette (Pour fraise CBMP/ECMP/TAB)	L030
KSS0	Vis de fixation	N010	MPMW00000000	Plaquette (Pour fraise TSMP)	K233, L030
KSS2	Vis de réglage	N010	MPMX12041200	Plaquette (Pour fraise SPX)	K205, L030
L			MP6	Goupille	N014
LK1	Bride de serrage	N016	MSCN63	Assise	N012
			MSSN63	Assise	N012
			MTK0R/L	Bride de serrage	N016

INDEX REFERENCES OUTILS

Référence	NOMS DES PRODUITS	Page	Référence	NOMS DES PRODUITS	Page
N			S		
NNMU130500ZEN-0	Plaquette (Pour fraise AHX440S).....	K035, K039, L030	RS0000T	Vis de fixation	N006
NNMU130508ZER-L	Plaquette (Pour fraise AHX440S).....	K035, L030	S0	Vis de fixation	N006
NNMU200000ZEN-0	Plaquette (Pour fraise AHX440S).....	K042, L031	SC00M00S00-HSK63A	Attachement HSK63	K244
NNMU200000ZEN-00	Plaquette (Pour fraise AHX).....	K042, K049, L031	SC00M00S00S/L	Attachement cylindrique	K244
NNMU200608ZEN-0K	Plaquette (Pour fraise AHX640W*640S).....	K042, K049, L031	SC00M00S00S/LW	Attachement cylindrique (Corps carbure) ...	K244
NNMU200712ZER-L	Plaquette (Pour fraise AHX640S).....	K042, L031	SD00	Vis.....	N006
NNMU200712ZER-MM	Plaquette (Pour fraise AHX640S).....	K042, L031	SDEN1203AEN	Plaquette (Pour fraise à 45°).....	L035
NP-GOER14000PXSRO5	Plaquette (Pour fraise FMAX).....	K054, L051	SECN0000EFOR1	Plaquette (Pour fraise SE415*515/QSE415).....	L051
NS0000	Vis de fixation	N006	SEEN0000AFON0	Plaquette (Pour fraise SE445*545)	L035
NS0000W	Vis de fixation	N006	SEEN0000EFOR0	Plaquette (Pour fraise SE415*515/QSE415).....	L035, L036
O			SEER0000AFEN-JS	Plaquette (Pour fraise SE445*545/LSE445) ...	L035
OEMX0000EOR1	Plaquette (Pour fraise OCTACUT).....	L031	SEER1203EFER-JS	Plaquette (Pour fraise SE*QSE415).....	L036
OEMX0000EOR1-JS	Plaquette (Pour fraise OCTACUT).....	L031	SEET13T3AGEN-JL	Plaquette (Pour fraise ASX445)	K028, L036
P			SEEW1204AFTN	Plaquette (Pour fraise à 45°).....	L036
PMF00000A00R	Fraise PMF	K234	SEGT13T3AGFN-JP	Plaquette (Pour fraise ASX445)	K028, L036
PMR000000A20R	Fraise PMR.....	K236	SEMN1204AZTN	Plaquette (Pour fraise à 45°).....	L036
PMR000000BR	Fraise PMR.....	K236	SEMT13T3AGSN-FT	Plaquette (Pour fraise ASX445)	K028, L036
P00S	Excentrique.....	N015	SEMT13T3AGSN-JH	Plaquette (Pour fraise ASX445)	K028, L037
PS00	Assise.....	N011	SEMT13T3AGSN-JM	Plaquette (Pour fraise ASX445)	K028, L037
PT00	Assise.....	N011	SETK00	Bride de serrage.....	N016
PT00TOR	Assise.....	N012	SETS00	Vis de fixation	N006
P000US	Excentrique (Pour P.O. ML).....	N015	SFAN0000ZFF02	Plaquette (Pour fraise BF407).....	L037
PV000	Assise.....	N013	SFCN0000ZFFR2	Plaquette (Pour fraise BF*QBF407)	L037
P000W	Excentrique (Pour P.O. ML).....	N015	SLCS0000	Vis de fixation	N006
P000WS	Excentrique (Pour P.O. ML).....	N015	SNC43B2S	Plaquette (Pour fraise BN425DN).....	L037
Q			SNEN0000EN	Plaquette (Classe tolérance E).....	L037
QOGT0000R-G1	Plaquette (Pour fraise AQX).....	K175, L032	SNGU000000ANE0-0	Plaquette (Pour fraise WSX445)	K019, L037
QOMT0000R-M2	Plaquette (Pour fraise AQX).....	K175, L032	SNMF43B2G	Plaquette (Pour fraise BN425/DN).....	L037
R			SOET12T308PEER-JL	Plaquette (Pour fraise ASX400)	K070, L038
RDHX0000M00	Plaquette (Classe tolérance H).....	L032	SOGT12T308PEFR-JP	Plaquette (Pour fraise ASX400)	K070, L038
RDMX0000M00	Plaquette (Classe tolérance M).....	L033	SOMT12T300PEE0-00	Plaquette (Pour fraise ASX400)	K070, L038
RDZX0000M00	Plaquette (Classe tolérance M).....	J139, L033	SONX1206PE0	Plaquette (Pour fraise VOX400).....	K066, L038
REMXX0000EN-JS	Plaquette (Pour fraise OCTACUT).....	L033	SPEN1203EETR1	Plaquette (Pour fraise FBP415).....	L051
REMXX0000SN	Plaquette (Pour fraise OCTACUT).....	L033	SPEN424A	Plaquette (Pour fraise FP490*590*690)	L039
RGEN2004M00N	Plaquette (Pour fraise SG20)	L033	SPEN0000ED0	Plaquette (Pour fraise à 15°).....	L039
RKY00S	Clé	N002	SPEN0000EEE01	Plaquette (Pour fraise FBP415/QBP415)....	L039
RN-S0	Vis de fixation.....	N006	SPER1203EEER-JS	Plaquette (Pour fraise FBP415/QBP415)....	L039
RPHT0000M0E4-0	Plaquette (Pour fraise ARP)	K241, L034	SPGN0000000	Plaquette (positive 11°)	L040
RPMT0000M0E0-00	Plaquette (Pour fraise ARP5/6).....	K241, L034	SPGX1204100PPER-JM	Plaquette (Pour fraise ASPX).....	K210, L040
RPMT0000M0E-JS	Plaquette (Pour fraise BRP).....	K191, L034	SPMB1204APT	Plaquette (Pour fraise BSP)	L040
RPMT0000M0E4-0	Plaquette (Pour fraise ARP).....	K241, L034	SPMN0000000	Plaquette (positive 11°)	L040
RPMW0000M00	Plaquette (Pour fraise BRP).....	K191, L034	SPMN0000000T	Plaquette (positive 11°)	L040
			SPMT120408-A	Plaquette (Pour fraise TBE1).....	L040
			SPMW0000000	Plaquette (Pour fraise CESP/CFSP/CGSP).....	L040, K230
			SPMX120408-00	Plaquette (Pour fraise SPX)	K205, L041

Référence	NOMS DES PRODUITS	Page	Référence	NOMS DES PRODUITS	Page
SPNN1203EDR	Plaquette (Pour fraise à 15°)	L041	U		
SPSVN32	Assise	N013	UCR	Bride de serrage	N016
SPS1	Vis de support	N006	V		
SPX4-0000A24A058RA	Fraise SPX	K204	VFX5-000000A000R	Fraise VFX5	K192
SPX4R00000SK50N0	Fraise SPX	K203	VFX6-0000A00A000R	Fraise VFX6	K196
SRBT00	Plaquette (Pour type SRB)	K214, L042	VOX400-000000R	Fraise à surfacer VOX400	K065
SRFH00AM0000	Fraise SRF	K213, K217	VPX200-000A00A000R00	Fraise VPX200	K116
SRFH00S00000	Fraise SRF	K213, K214, K216, K217	VPX200-0000A00AR	Fraise VPX200	K089
SRFT00	Plaquette (Pour fraise SRF)	K214, L042	VPX200R00000AM00000	Fraise VPX200	K088
SRG00C	Plaquette (Pour fraise SRM2)	K223, K229, L042	VPX200R000SA00S00000	Fraise VPX200	K114
SRG00E	Plaquette (Pour fraise SRM2)	K223, K229, L042	VPX200R0000SA00S/L	Fraise VPX200	K086
SRK1R	Bride de serrage	N016	VPX200R0000WA00S00000	Fraise VPX200	K115
SRM00C-M	Plaquette (Pour fraise SRM2)	K223, L043	VPX200R00000WA00S/M	Fraise VPX200	K087
SRM00E-M	Plaquette (Pour fraise SRM2)	K223, L043	VPX300-000A00AR	Fraise VPX300	K103
SRM2000AM/M00S/L00/L	Fraise SRM2	K222	VPX300-000A00A000R00	Fraise VPX300	K125
SRM2000I00NLM/S	Fraise SRM2	K228	VPX300R00000AM00000	Fraise VPX300	K102
SRM20000NL0	Fraise SRM2	K228	VPX300R00000SA00S/L	Fraise VPX300	K100
SRM2000S00	Fraise SRM2	K220, K221	VPX300R00000WA00S	Fraise VPX300	K101
SRS5	Vis de fixation	N006	VPX300R402SA32S00000	Fraise VPX300	K124
STASX000N	Assise	N013	W		
STBS500N	Assise	N013	WCS000000H	Vis d'assise	N008
STS1	Vis d'assise	N006	WEC42EFTR5C	Plaquette de planage (Pour fraise SE415*515)...	L049
SUFT00R00	Plaquette (Pour fraise SUF)	K218, L043	WEC53AFTR5C	Plaquette de planage (Pour fraise SE445*545/LSE445)	L049
T			WEC53EFTR5C	Plaquette (Pour fraise SE515)	L049
TECN00000PEOR1	Plaquette (Pour fraise NSE300*400/SE300*400)	L044, L051	WEEW13T3AGOR3C	Plaquette de planage (Pour fraise ASX445)	K029, L052
TECN1603PEOR1W	Plaquette (Pour fraise NSE300/SE300)	L044	WEEW13T3AGOR8C	Plaquette de planage (Pour fraise ASX445)	K029, L049
TEEN00000PEOR/L0	Plaquette (Pour fraise NSE300*400/SE300*400)	L044	WJX09-000000AR	Fraise WJX09	K072
TEER00000PEER-JS	Plaquette (Pour fraise NSE300*400)	L044	WJX09R00000SA000	Fraise WJX09	K073
TIP000	Clé	N002	WJX14-000000AR	Fraise WJX14	K079
TKY00D	Entraîneur	N002	WJX14R5003SA420	Fraise WJX14	K080
TKY00F	Clé drapeau	N002	WNEU1305ZEN4C-M	Plaquette de planage (Pour fraise AHX)	K029, L049
TKY00L	Clé longue	N002	WNEU2000ZEN7C-0/00	Plaquette de planage (Pour fraise AHX)	K042, K049, L049, L050
TKY00R	Clé L	N002	WNGU1406ANEN8C-M	Plaquette de planage (Pour fraise WSX445)	K019, L050
TKY00T	Clé T	N002	WOWE12T308PEOR8C	Plaquette de planage (Pour fraise ASX400)	K050, L050
TKY00W	Clé drapeau	N002	WOEX1206PER5C	Plaquette (Pour fraise VOX400)	L050
TPEN00000P00	Plaquette (Pour fraise à 0°)	L045	WPC42EEOR10C	Plaquette de planage (Pour fraise FBP415/QBP415)	L050
TPEW1303ZPOR2	Plaquette (Pour fraise PMF)	K234, L045, L052	WPSTN00	Assise	N013
TPMN0000000	Plaquette (positive 11°)	L045	WPSWC43	Assise	N013
TPMN0000000T	Plaquette (positive 11°)	L045			
TPNN2204PDR	Plaquette (Pour fraise à 0°)	L045			
TPS0	Vis de fixation	N008			
TSMPR0000S00	Fraise TSMP	K232			
TS0	Vis de fixation	N007			
TSR000000S	Vis de fixation	N008			
TSS000000	Vis de pré-réglage	N008			

INDEX REFERENCES OUTILS

Référence	NOMS DES PRODUITS	Page	Référence	NOMS DES PRODUITS	Page
WPSWN43	Assise	N013			
WS	Vis de fixation	N008			
WS	Vis de fixation	N008			
WSX445	Fraise à surfacer WSX445	K017			
WSX445	Fraise à surfacer WSX445	K016			
WSX445R	Fraise à surfacer WSX445	K018			
WWX400	Fraise WWX400	K056			
WWX400R	Fraise WWX400	K058			
X					
XDGX	Plaquette (Pour fraise AXD4000)	K157, K163, L046			
XDGX	Plaquette (Pour fraise AXD4000*7000)	K157, K163, K167, L046			
XDGX	Plaquette (Pour fraise AXD4000)	K157, K163, L046			
XNMU	Plaquette (Pour fraise VFX5*VFX6)	K194, K198, L047			
Z					
ZCMX	Plaquette (Pour fraise DCCC)	K201, L048			
NUMÉROS • AUTRES					
6NGU	Plaquette (Pour fraise WWX400)	K059, L022			
6NMU	Plaquette (Pour fraise WWX400)	K059, L022			

MITSUBISHI MATERIALS CORPORATION

GERMANY

MMC HARTMETALL GMBH
Comeniusstr. 2 . 40670 Meerbusch
Phone +49 2159 91890 . Fax +49 2159 918966
Email admin@mmchg.de

U.K.

MMC HARDMETAL U.K. LTD.
Mitsubishi House . Galena Close . Tamworth . Staffs. B77 4AS
Phone +44 1827 312312 . Fax +44 1827 312314
Email sales@mitsubishicarbide.co.uk

SPAIN

MITSUBISHI MATERIALS ESPAÑA, S.A.
Calle Emperador 2 . 46136 Museros/Valencia
Phone +34 96 1441711 . Fax +34 96 1443786
Email comercial@mmevalencia.es

FRANCE

MMC METAL FRANCE S.A.R.L.
6, Rue Jacques Monod . 91400 Orsay
Phone +33 1 69 35 53 53 . Fax +33 1 69 35 53 50
Email mmfsales@mmc-metal-france.fr

POLAND

MMC HARDMETAL POLAND SP. Z O.O
Al. Armii Krajowej 61 . 50 - 541 Wrocław
Phone +48 71335 1620 . Fax +48 71335 1621
Email sales@mitsubishicarbide.com.pl

ITALY

MMC ITALIA S.R.L.
Viale Certosa 144 . 20156 Milano
Phone +39 0293 77031 . Fax +39 0293 589093
Email info@mmc-italia.it

TURKEY

MMC HARTMETALL GMBH ALMANYA - İZMİR MERKEZ ŞUBESİ
Adalet Mahallesi Anadolu Caddesi No: 41-1 . 15001 35530 Bayraklı/İzmir
Phone +90 232 5015000 . Fax +90 232 5015007
Email info@mmchg.com.tr

www.mitsubishicarbide.com | www.mmc-hardmetal.com

C009F

Publication: 2022.04 (3.0 DP), imprimé en Allemagne